

Owner's Manual  
for Vehicle



The Ultimate  
Driving Machine





**750i**  
**750Li** **Owner's Manual for Vehicle**

Congratulations, and thank you for choosing a BMW.

**760i**  
**760Li**

Thorough familiarity with your vehicle will provide you with enhanced control and security when you drive it. We therefore have this request:

Please take the time to read this Owner's Manual and familiarize yourself with the information that we have compiled for you before starting off in your new vehicle. It contains important data and instructions intended to assist you in gaining maximum use and satisfaction from your BMW's unique range of technical features. The manual also contains information on maintenance designed to enhance operating safety and contribute to maintaining the value of your BMW throughout an extended service life.

This manual is supplemented by a Service and Warranty Information Booklet for US models or a Warranty and Service Guide Booklet for Canadian models.

We wish you an enjoyable driving experience.

BMW AG

© 2007 Bayerische Motoren Werke  
Aktiengesellschaft  
Munich, Germany  
Reprinting, including excerpts,  
only with the written consent of  
BMW AG, Munich.  
Order No. 01 41 0 013 316  
US English II/07, 07 03 450  
Printed in Germany  
Printed on environmentally friendly paper,  
bleached without chlorine, suitable for recycling.

# Contents

The fastest way to find specific topics is to use the index, refer to page [232](#).

## Using this Owner's Manual

4 Notes

## At a glance

10 Cockpit

16 iDrive

23 Voice command system

## Controls

30 Opening and closing

43 Adjusting

54 Transporting children safely

57 Driving

75 Everything under control

86 Technology for comfort, convenience and safety

100 Lamps

103 Climate

111 Practical interior accessories

## Driving tips

122 Things to remember when driving

## Navigation

130 Starting navigation system

131 Destination input

144 Route guidance

149 What to do if ...

## Entertainment

152 On/off and settings

156 Radio

163 CD player

165 CD changer

169 External audio device

170 DVD changer

## Communications

178 Telephone overview

181 Getting started

184 Using the phone

189 BMW Assist

## Mobility

198 Refueling

200 Wheels and tires

207 Under the hood

211 Maintenance

213 Replacing components

219 Giving and receiving assistance

## Reference

226 Technical data

230 Short commands of the voice command system

232 Everything from A to Z

# Notes

## Using this Owner's Manual

In compiling this Owner's Manual we have made every effort to furnish you with a convenient reference source affording quick access to all the essentials. The fastest way to find detailed information on any specific subject is to turn to the comprehensive index at the back of the manual. For a brief initial overview, please refer to the first chapter.

Should the day come when you decide to sell your BMW, please remember to make certain that the new owner receives this Owner's Manual; it is an important part of the vehicle.

### Additional sources of information

If you have any additional questions, your BMW center will be glad to advise you.

You can find information on BMW, e.g. on technology, on the Internet at [www.bmwusa.com](http://www.bmwusa.com).

## Symbols used



Indicates precautions that must be followed precisely in order to avoid the possibility of personal injury and serious damage to the vehicle. ◀



Indicates information that will assist you in gaining the optimum benefit from your vehicle and enable you to care more effectively for your vehicle. ◀



Refers to measures that can be taken to help protect the environment. ◀

◀ Marks the end of a specific item of information.

\* Indicates special equipment, country-specific equipment and optional extras, as well as equipment and functions not yet available at the time of printing.

"..." Identifies Control Display texts used to select individual functions.



These sections contain information on using the voice command system.

>...◀ Verbal instructions to use with the voice command system.

>>...◀◀ Identifies the answers generated by the voice command system.

### Symbols on vehicle components



Indicates that you should consult the relevant section of this Owner's Manual for information on a particular part or assembly.

## Your individual vehicle

In purchasing your BMW, you have decided in favor of a model with individualized equipment and features. This Owner's Manual describes the entire array of options and equipment available with a specific BMW model.

Please bear in mind that the manual may contain information on accessories and equipment that you have not specified for your own vehicle. Sections describing options and special equipment are marked by asterisks \* to assist you in identifying possible differences between the descriptions in this manual and your own vehicle's equipment.

If equipment in your BMW is not described in this Owner's Manual, please refer to the accompanying Supplementary Owner's Manuals.

## Editorial notice

BMW pursues a policy of continuous, ongoing development that is conceived to ensure that our vehicles continue to embody the highest quality and safety standards combined with advanced, state-of-the-art technology. For this reason, the features described in this Owner's Manual may in rare cases differ from those on your vehicle.

## For your own safety

### Maintenance and repairs



Advanced technology, e.g. the use of modern materials and high-performance electronics, requires specially adapted maintenance and repair methods. Therefore, have corresponding work on your BMW performed only by your BMW center or a workshop that works according to BMW repair procedures with correspondingly trained personnel. If this work is not carried out properly, there is a danger of subsequent damage and related safety hazards. ◀

### Parts and accessories



For your own safety, use genuine parts and accessories approved by BMW. When you purchase accessories tested and approved by BMW and Genuine BMW Parts, you simultaneously acquire the assurance that they have been thoroughly tested by BMW to ensure optimum performance when installed on your vehicle. BMW warrants these parts to be free from defects in material and workmanship. BMW will not accept any liability for damage resulting from installation of parts and accessories not approved by BMW. BMW cannot test every product made by other manufacturers to verify if it can be used on a BMW safely and without risk to either the vehicle, its operation, or its occupants. Genuine BMW Parts, BMW Accessories and other products approved by BMW, together with professional advice on using these items, are available from all BMW centers. Installation and operation of non-BMW approved accessories such as alarms, radios, amplifiers, radar detectors, wheels, suspension components, brake dust shields, telephones, including operation of any mobile phone from within the vehicle without using an externally mounted antenna, or transceiver equipment, for instance, CBs, walkie-talkies, ham radios or similar accessories, may cause extensive damage to the vehicle, compromise its safety, interfere with the vehicle's electrical system or affect

the validity of the BMW Limited Warranty. See your BMW center for additional information. ◀

 Maintenance, replacement, or repair of the emission control devices and systems may be performed by any automotive repair establishment or individual using any certified automotive part. ◀

### California Proposition 65 Warning

California laws require us to issue the following warning:

 Engine exhaust and a wide variety of automobile components and parts, including components found in the interior furnishings in a vehicle, contain or emit chemicals known to the State of California to cause cancer and birth defects and reproductive harm. In addition, certain fluids contained in vehicles and certain products of component wear contain or emit chemicals known to the State of California to cause cancer and birth defects or other reproductive harm.

Battery posts, terminals and related accessories contain lead and lead compounds. Wash your hands after handling. Used engine oil contains chemicals that have caused cancer in laboratory animals. Always protect your skin by washing thoroughly with soap and water. ◀

## Service and warranty

We recommend that you read this publication thoroughly.

Your BMW is covered by the following warranties:

- ▷ New Vehicle Limited Warranty
- ▷ Rust Perforation Limited Warranty
- ▷ Federal Emissions System Defect Warranty
- ▷ Federal Emissions Performance Warranty
- ▷ California Emission Control System Limited Warranty

Detailed information about these warranties is listed in the Service and Warranty Information Booklet for US models or in the Warranty and Service Guide Booklet for Canadian models.

## Reporting safety defects

### For US customers

The following only applies to vehicles owned and operated in the US.

If you believe that your vehicle has a defect which could cause a crash or could cause injury or death, you should immediately inform the National Highway Traffic Safety Administration (NHTSA) in addition to notifying BMW of North America, LLC, P.O. Box 1227, Westwood, New Jersey 07675-1227, Telephone 1-800-831-1117.

If NHTSA receives similar complaints, it may open an investigation, and if it finds that a safety defect exists in a group of vehicles, it may order a recall and remedy campaign. However, NHTSA cannot become involved in individual problems between you and your dealer or BMW of North America, LLC.

To contact NHTSA, you may call the Vehicle Safety Hotline toll-free at 1-888-327-4236 (TTY: 1-800-424-9153); go to <http://www.safercar.gov>; or write to: Administrator, NHTSA, 400 Seventh Street, SW., Washington, DC 20590. You can also obtain other information about motor vehicle safety from <http://www.safercar.gov>



## For Canadian customers

Canadian customers who wish to report a safety-related defect to Transport Canada, Defect Investigations and Recalls, may call 1-800-333-0510 toll-free from anywhere in Canada or 1-613-993-9851 from the Ottawa region and from other countries, or contact Transport Canada by mail at: Transport Canada, ASFAD, Place de Ville, Tower C, 330 Sparks Street, Ottawa, ON, K1A 0N5. You can also obtain other information about motor vehicle safety from <http://www.tc.gc.ca>











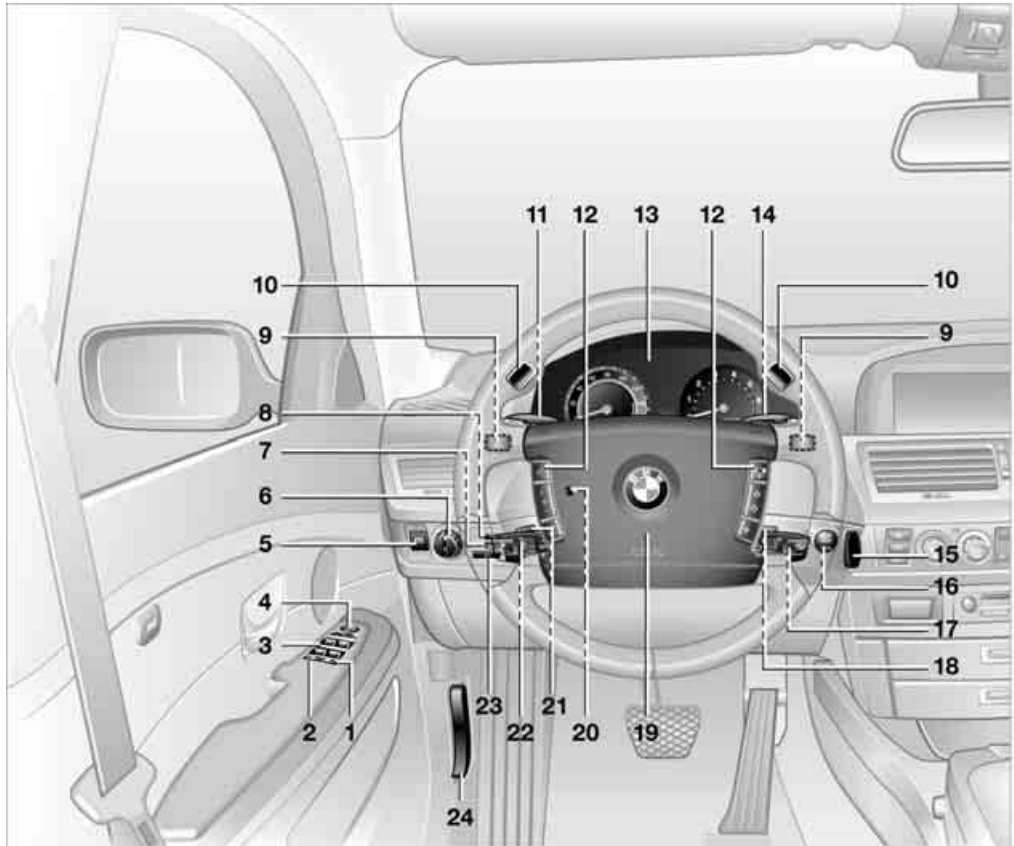

## At a glance

















This overview of buttons, switches and displays is intended to orient you in your vehicle's operating environment. It will also assist you in becoming acquainted with the control concepts and options available for operating the various systems.









# Cockpit

## All around the steering wheel: controls and displays



- |   |                                   |     |   |                                                                                                                |     |
|---|-----------------------------------|-----|---|----------------------------------------------------------------------------------------------------------------|-----|
| 1 | Roller sun blind for rear window* | 112 | 5 | Parking brake                                                                                                  | 58  |
| 2 | Rear window safety switch         | 40  | 6 |  Parking lamps              | 100 |
| 3 | Power windows                     | 40  | 7 |  Low beams                  | 100 |
| 4 | Exterior mirrors                  | 50  | 8 |  Daytime running lamps*     | 100 |
|   |                                   |     |   |  Automatic headlamp control | 100 |
|   |                                   |     |   |  Daytime running lamps*     | 100 |
|   |                                   |     |   |  Adaptive Head Light*       | 100 |
|   |                                   |     | 7 |  Instrument lighting        | 101 |
|   |                                   |     | 8 |  BMW Night Vision*          | 97  |

- 9** Steptronic: upshifting [63](#)
- 10** Steptronic: downshifting [63](#)
- 11**  Turn signals [65](#)
-  High beams, headlamp flasher [101](#)
-  Roadside parking lamps [101](#)
-  Computer [76](#)
-  Check Control [80](#)
-  Computer [76](#)
- 12** Buttons on steering wheel
-  Voice command system\* activation/deactivation [23](#)
-  Entertainment volume, increasing/decreasing [152](#)
-  Volume of hands-free unit, increasing/decreasing [179](#)
-  Mobile phone:  
Calling, redialing, accepting call or ending call [184](#)
-  Sport program and manual operation of the automatic transmission [63](#)
-  Selecting radio station [156](#)
-  Selecting music track [163, 166](#)
-  Skipping chapter\* [172](#)
-  Programmable button [52](#)
- 13** Info Display [12](#)
- 14** Automatic transmission [62](#)
- 15** Ignition lock [57](#)
- 16**  Switching ignition on/off [57](#) and Starting/stopping engine [57](#)

- 17**  Windshield wipers [65](#)
-  Rain sensor [65](#)
- 18**  PDC Park Distance Control\* [86](#)
- 19** Horn, the entire surface
- 20**  Steering wheel heater\* [52](#)
-  Steering wheel adjustment [51](#)
- 21**  Opening luggage compartment lid [36](#)
- 22**  Programmable cruise control [67](#)
-  Active cruise control\* [69](#)
- 23** Fog lamps [101](#)
-  Front fog lamps
- 24** Unlocking hood [207](#)

## Info Display

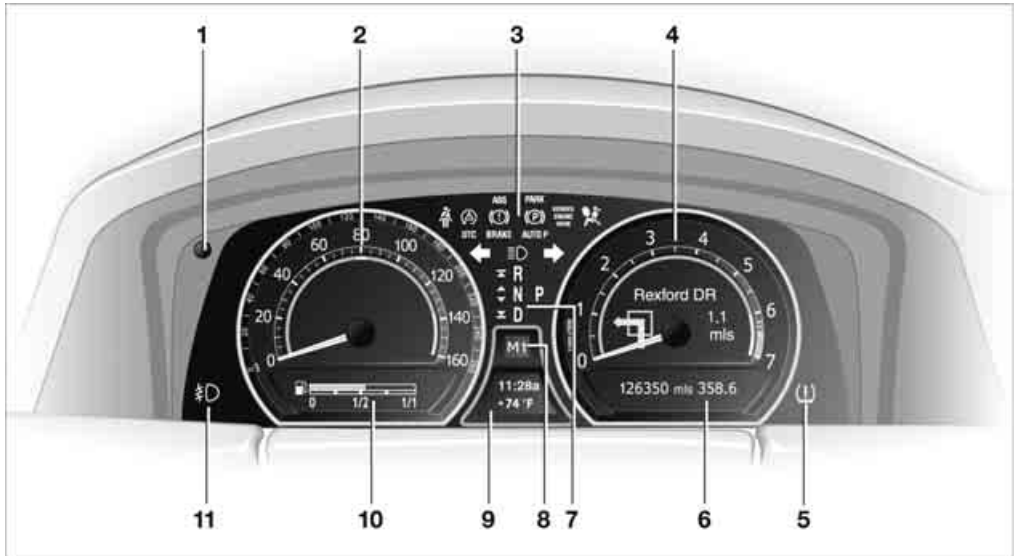

VWCCLEBRANT

- 1 Resetting trip odometer to zero [75](#)
- 2 Speedometer with display for
  - ▷ Programmable cruise control [67](#)
  - ▷ Active cruise control\* [69](#)
  - ▷ Speed limit [82](#)
- 3 Indicator and warning lamps [13](#)
- 4 Tachometer [75](#)  
Route guidance of navigation system\* [144](#)
- 5 Display for
  - ▷ Flat Tire Monitor\* [91](#)
  - ▷ Tire Pressure Monitor\* [93](#)
- 6 Display for
  - ▷ Voice command system\* [23](#)
  - ▷ Odometer and trip odometer [75](#)
  - ▷ Text messages in Check Control [80](#)
  - ▷ Computer [76](#)
- 7 Transmission range selection [62](#)
- 8 Automatic transmission program display [62](#)
- 9 Display for
  - ▷ Outside temperature [75](#)
  - ▷ Clock [75](#)
  - ▷ Indicator and warning lamps [80](#)
- 10 Display for
  - ▷ Computer with fuel gauge [76](#)
  - ▷ Remaining driving distance for service requirements [78](#)
- 11 Fog lamps [101](#)

# Indicator and warning lamps

## The concept



Control and warning lamps can light up in various combinations and colors.

When the engine is started or the ignition is switched on, some lamps are checked for proper operation and light up briefly in the process.

## Explanatory text messages



Text messages on Info Display explain the meaning of the indicator and warning lamps shown.

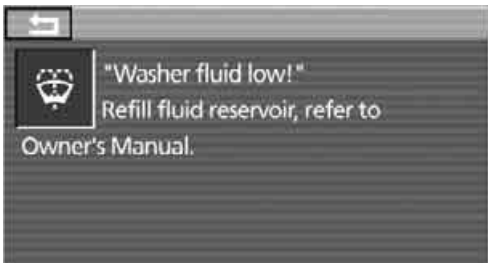







You can view additional information, e.g. regarding the cause of a malfunction and the corresponding action to take, in the Check Control, refer to page 80.

In urgent cases, this information will be shown as soon as the corresponding lamp comes on.

## Indicator lamps without text messages

The following indicator lamps indicate that the particular functions are active:

-  Turn signals [65](#)
-  With parking brake released [59](#)  
With parking brake set [58](#)
-  Warning lamp on Canadian models
-  Front fog lamps [101](#)
-  DTC Dynamic Traction Control [88](#)
-  High beams/headlamp flasher [101](#)
-  DSC Dynamic Stability Control, flashes [88](#)

## Comfort area: controls and displays

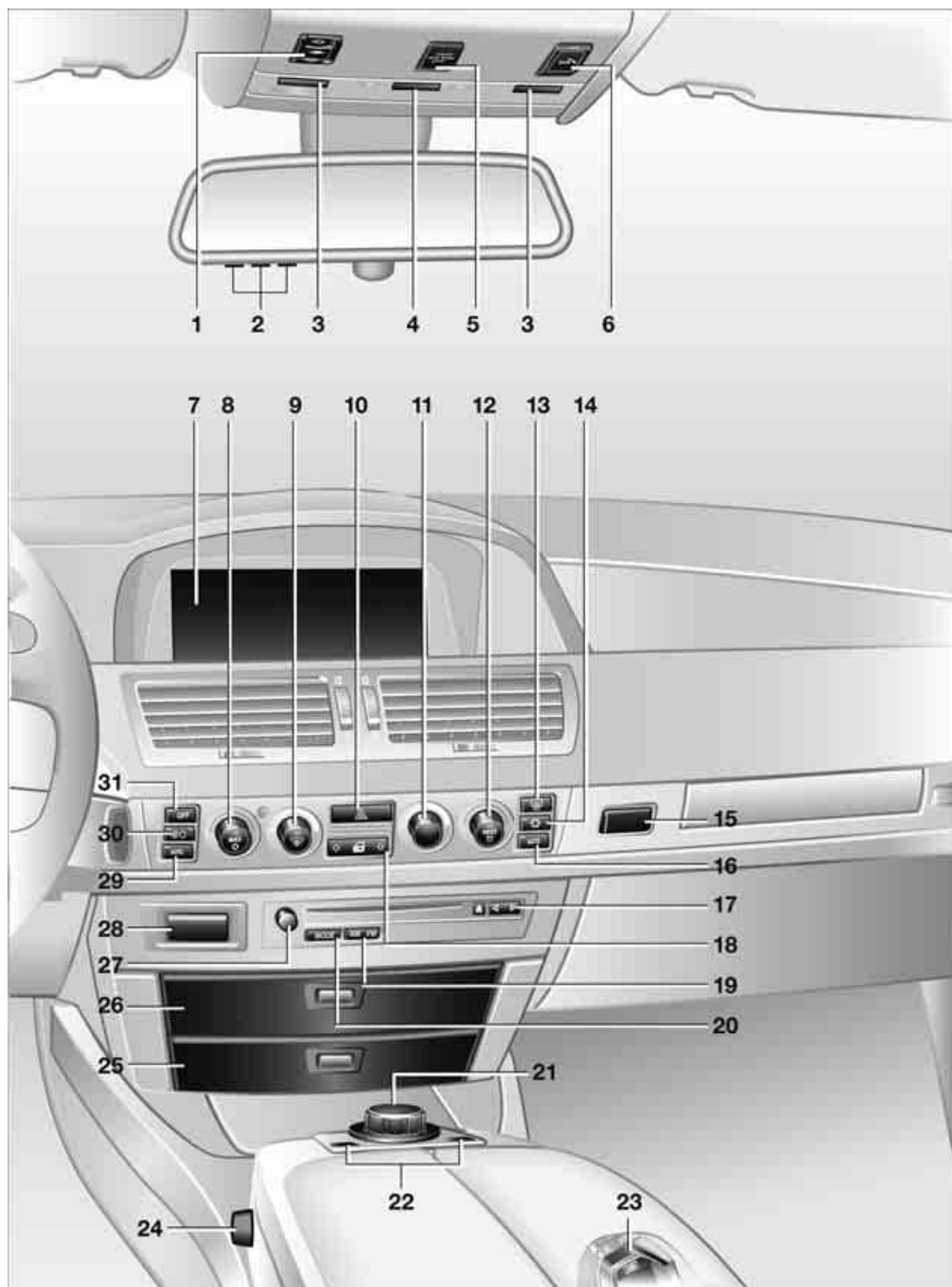



- 1 Glass sunroof, electric\* 41
- 2 Memory buttons for integrated universal remote control\* 111
- 3 Reading lamps 102
- 4 Interior lamps 101
- 5 Passenger airbag status lamp 96
- 6 Initiating an emergency call\* 219
- 7 Control Display 16
- 8 Temperature, left side of passenger compartment: turn, maximum cooling: press 106
- 9 Air volume, left side of passenger compartment: turn 106  
Defrosting windows and removing condensation: press 106
- 10 Hazard warning flashers
- 11 Air volume, right side of passenger compartment 106
- 12 Temperature, right side of passenger compartment: turn, residual heat: press 106
- 13 Rear window defroster
- 14 Air conditioner mode 107
- 15 Opening the glove compartment 113
- 16 Automatic air distribution and airflow as well as intensity of the AUTO program, right side of passenger compartment 104
- 17 Starting scan
  - ▷ for stations 152
  - ▷ for tracks 152
- 18 Central locking system 34
- 19 Selecting AM or FM waveband
- 20 Selecting radio, CD player, and CD changer
- 21 Controller 16
- 22 **MENU** button and programmable button 16
- 23 Snap-in adapter 181

24 Seat adjustment 43



Heated seats\* 49



Active seat ventilation\* 50



Active seat for driver\* 50



Seat, mirror and steering wheel memory 46

25 Glasses compartment 115

26 Storage compartments 115

27 Switching audio sources on/off and adjusting volume 153

28 Retracting telephone keypad 179

29 Automatic air distribution and airflow as well as intensity of the AUTO program, left side of passenger compartment 104

30 Outside air/AUC Automatic recirculated-air control/recirculated air 105

31 Switching off automatic climate control 105

iDrive combines the functions of a multitude of switches. This allows these functions to be operated from a central position. The following introduction illustrates how easy iDrive is to

use. The control of individual functions is described in connection with the relevant equipment.

## Controls



- 1 Control Display
- 2 Programmable button 52
- 3 **MENU** button  
Opening start menu
- 4 Controller  
You can use the controller to select menu items and make settings:
  - ▷ move in four directions, arrows 5
  - ▷ turn, arrow 6
  - ▷ press, arrow 7

**⚠** To avoid becoming distracted and posing an unnecessary hazard, both to your own vehicle's occupants and to other road users: never attempt to use the controls or make entries unless traffic and road conditions allow. ◀

### Switching Control Display off/on

1. Press the **MENU** button to open the start menu.
2. Press the controller.  
Press the controller again to switch the screen back on.

# Menus on Control Display

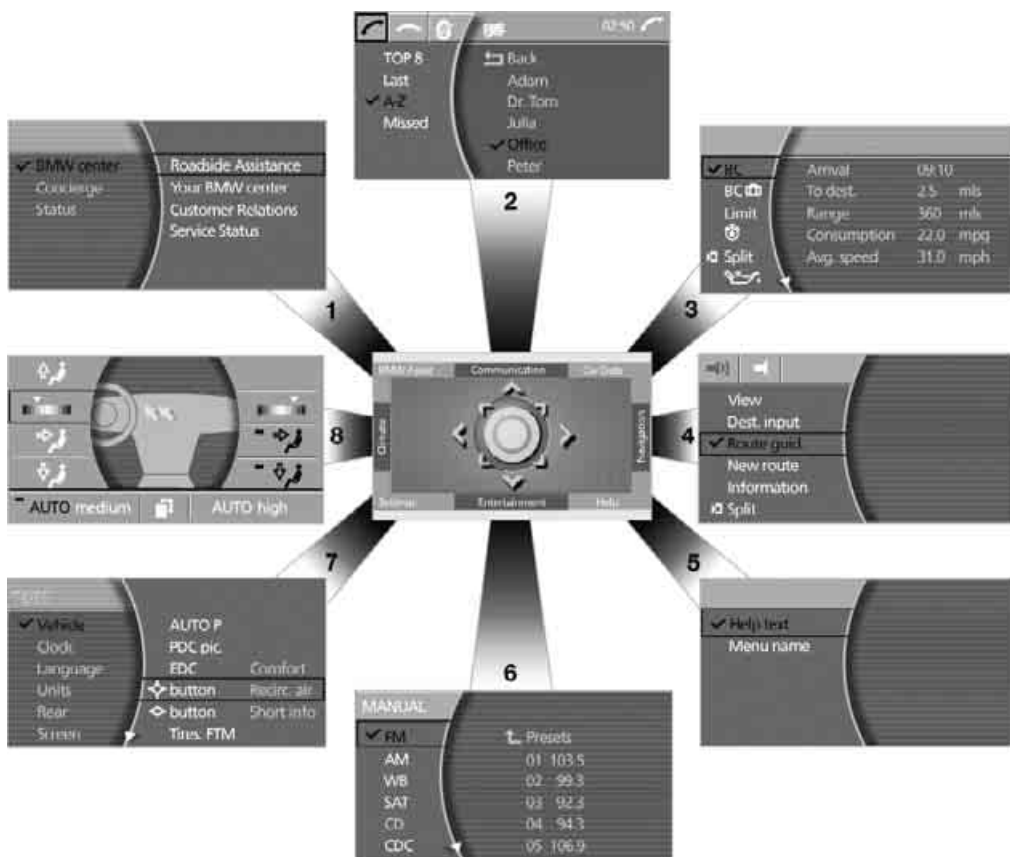

You can select from an extended range of functions and setting options:

- 1 BMW Assist\* 189
- 2 Communication\*
  - ▷ Using the phone 184
- 3 Car Data
  - ▷ Computer 76
  - ▷ Trip computer 78
  - ▷ Speed limit 82
  - ▷ Stopwatch 83
  - ▷ Assistance window for onboard data 83
  - ▷ Engine oil level 208
  - ▷ Service required 78
  - ▷ Check Control messages 80

- 4 Navigation\* 130
  - ▷ Destination input 131
  - ▷ Route guidance 144
- 5 Help
  - ▷ Brief help text displays 21
  - ▷ Menu name for menu change 19
- 6 Entertainment
  - ▷ Radio 156
  - ▷ CD player\* 163
  - ▷ CD changer\* 165
  - ▷ External audio device 169
  - ▷ DVD changer\* 170

 DVDs can only be played on the rear seat screen, refer to Rear seat screen\* on page 21. ◀

## 7 Settings

- ▷ Parking brake 58
- ▷ PDC Park Distance Control 86
- ▷ EDC Electronic Damping Control 89
- ▷ Programmable buttons 52
- ▷ FTM Flat Tire Monitor\* 90
- ▷ TPM Tire Pressure Monitor\* 91
- ▷ Time and date 84
- ▷ Language 84
- ▷ Units of measure and display format 84
- ▷ Brightness 85
- ▷ Rear seat screen\* 21
- ▷ Pairing mobile phone with vehicle 182

## 8 Climate

- ▷ Intensity of AUTO program 104
- ▷ Air volume 106
- ▷ Heated seats\* 49
- ▷ Parked car ventilation 109
- ▷ Extra, e.g. rear air conditioner 108

## Basic operation

Once the radio ready position is reached, the following message appears on the Control Display:

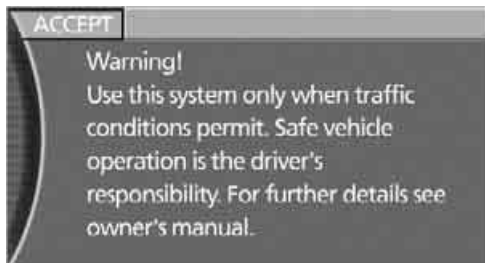

To clear the message:  
Press the controller.  
This displays the start menu.

The message automatically disappears after approx. 25 seconds.

## Start menu

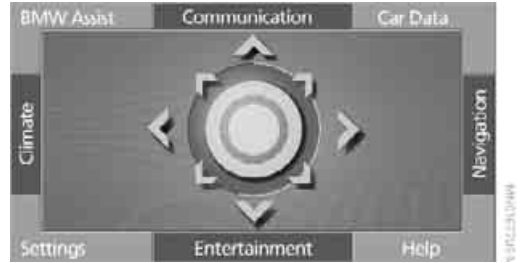

You can access all functions of iDrive via eight menu items.

### Opening start menu

Press the **MENU** button.

Opening the start menu from a menu:

- ▷ Move the controller toward the currently active menu.
- ▷ Move the controller twice in one direction.

### Selecting menu

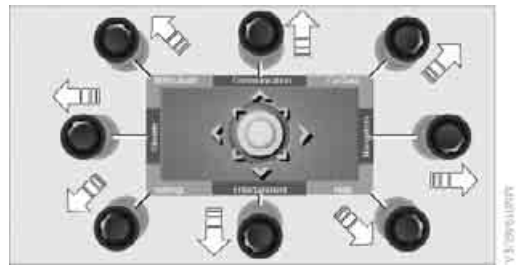

From the start menu, eight menus can be accessed by moving the controller in the appropriate directions.

 In a menu, you can change directly into a new menu by moving in the corresponding direction, without having to open the start menu first.

Moving in the direction that corresponds to the last menu used brings you back to the last item used in this menu. ◀

## Selecting menu items

To edit a function, select the corresponding menu item. Menu items shown in white can be selected.



Turn the controller  
The highlight moves.  
To change between the menu items on the left and right side of the Control Display, continue to turn the controller at the beginning or end of a list. The highlight moves to the other side of the Control Display.

## Activating menu item



Press the controller.

## Changing settings



1. Turn the controller to change the setting.
2. Press the controller to adopt the setting.

## Displaying and hiding menu name

You can program the system to display the menu name each time you proceed to a new menu.

1. Press the **MENU** button to open the start menu.
2. Move the controller toward "Help".
3. Select "Menu name" and press the controller.

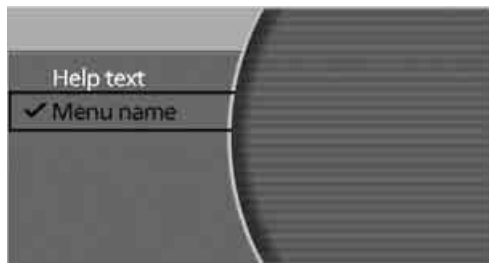

The ✓ symbol indicates the menu that is currently activated. The menu name is displayed.

## Symbols

Some functions and information are displayed in the form of symbols:

- ✓ The function is switched on.
- ↶ Back.
- ☑ The function is switched on.
- ⌂ "Split": to show the current display in the assistance window.

## Status lines

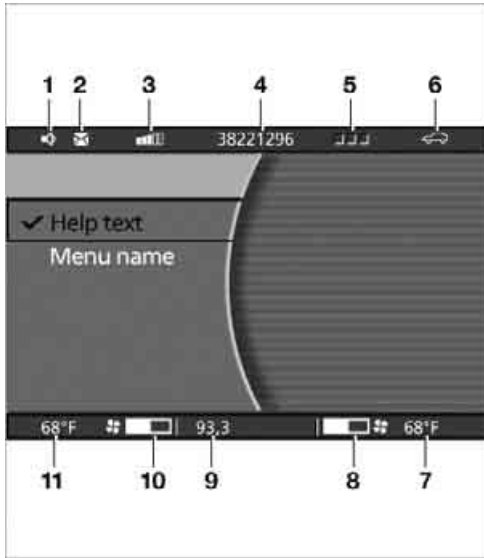

- 1** Hands-free mode active
- 2** A call has come in while you were away
- 3** Signal strength, mobile radio network\*
- 4** Here, you will see:
  - ▷ the name of the paired mobile phone
  - ▷ the entered/selected phone number
- 5** Phone status:
  - ▷ Green, yellow and red flashing: Pairing of a mobile phone
  - ▷ Green: Incoming or outgoing call
  - ▷ Red: No network available
  - ▷ Yellow: Partner network\* active, the network of another provider is being used
  - ▷ Flashing yellow: Visited network\* active, the network of another provider is being used, visited network\*
  - ▷  Roaming in a partner or external network incurs higher call charges than in your home network. ◀

- 6** There is a Check-Control message [80](#)  
You can have the Control Display show additional information using the menu "Car Data" under "CHECK" [81](#)  
Status service required [78](#)  
Red:  
At least one service interval has been exceeded. You can have more precise information about the maintenance procedure displayed by using the "Car Data" menu under  [79](#)
- 7** Temperature selection and intensity of the AUTO program, right side of passenger compartment
- 8** Air volume, right side of passenger compartment
- 9** Entertainment  
Display for radio, CD, and DVD  
With compressed audio files, the track information is displayed [167](#)
- 10** Air volume, left side of passenger compartment
- 11** Temperature selection and intensity of the AUTO program, left side of passenger compartment

## Assistance window

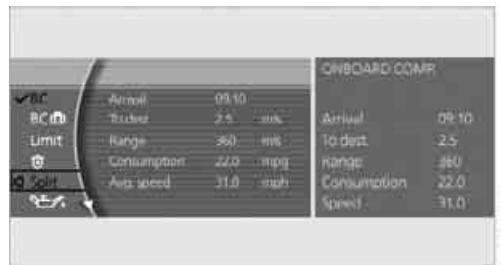

Additional information appears in the assistance window:

- ▷ Short help and supplementary information texts about selected menu items.
- ▷ A function selected from the "Car Data" menu, refer to page [83](#).
- ▷ The route with a navigation system, refer to page [130](#).

## Showing/hiding help texts

You can display help texts and supplementary information on selected menu items in the assistance window.

1. Press the **MENU** button to open the start menu.
2. Move the controller toward "Help".
3. Select "Help text" and press the controller.

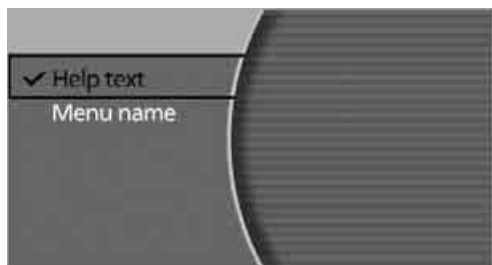

The ✓ symbol indicates the menu that is currently activated.

## Status lines



- 1 Outside temperature or town/city of destination of the navigation system
- 2 Time
- 3 Date

## Rear seat screen\*

Some of the functions of iDrive can also be operated via the rear seat screen. Certain functions are only available via iDrive. These functions can only be operated to a limited degree on the rear screen, e.g. the speed limit can only be displayed. The settings are made via iDrive.

### Deploying rear seat screen

1. Swing pivoting arm upward until it engages.
2. Fold rear seat screen upward.



The rear seat screen is ready for operation.

### Stowing rear seat screen

1. Align rear seat screen so that it is straight.
2. Fold rear seat screen downward until pivoting arm unlocks. Pivoting arm swings downward.

The rear seat screen is switched off.

 Pivot the rear seat screen completely downward when the ski bag is being used; otherwise, it could be damaged. Do not pivot the rear seat screen up or down with the cup holders open, as this can damage it. ◀

### Switching off rear seat screen

1. Press the **MENU** button to open the start menu.
2. Press the controller.

Press the controller again to switch the screen back on.

## Controller/buttons

The controller and buttons are located on the center armrest.

## Rear lock

The available functions are operated with the respective controller.

You can use iDrive to restrict operation in the rear or to switch off the rear seat screen.

iDrive, for principle details, refer to page 16.

1. Press the **MENU** button to open the start menu.
2. Move the controller toward "Settings".
3. Select "Rear" and press the controller.
4. Select "Unlock" and press the controller repeatedly until the desired enabling of the rear iDrive is set.

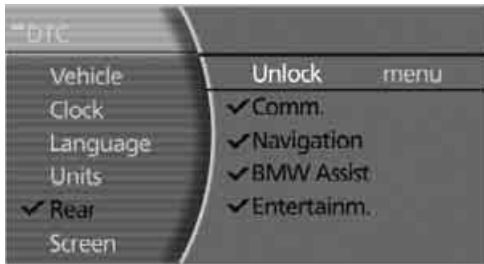

- ▷ "menu"
 

You can switch the offered menus on or off by turning and pressing the controller. The ✓ symbol indicates the menus that are currently activated.
- ▷ "None"
 

Switches the rear screen off.
- ▷ "Full"
 

Releases all function locks.
- ▷ "Limited"
 

You disable the functions that are used on the front Control Display.

## Headphones



- 1 Headphone jack
  - 2 Adjusting volume
  - 3 Station scan/track search
    - ▷ Station scan
    - ▷ Search track for CD, search chapter for DVD changer
-  With headphones connected, the sound output for the Control Display and the rear seat screen are played back separately. For example, a radio station can be listened to while a DVD is being played in the rear. ◀

Headphones are only intended for passengers in the rear seats. Please check with local regulations regarding use of headphones.



# Voice command system\*

## The concept

The voice command system allows you to control operation of various vehicle systems without ever removing your hands from the steering wheel. The system operates on the basis of voice commands that you will learn easily after using them a few times. In many cases, the voice command system assists you with announcements or questions while you are making your entries.

The voice command system transforms your oral commands and dialog answers into control signals for the selected systems.

 Please take the time to acquaint yourself with how a particular system operates before proceeding to control it using the voice command system. ◀

### Note

Use iDrive to set the language that will be used so that the voice command system will be able to identify the commands spoken. Setting the language of iDrive, refer to page 84.

## Symbols used

 These sections contain information on using the voice command system.

›...‹ Verbal instructions to use with the voice command system.

››...‹‹ Identifies the answers generated by the voice command system.

## Systems available for use with voice command

- ▶ ›Navigation‹, refer to page 130
- ▶ ›Radio‹, refer to page 156
- ▶ ›Telephone‹, refer to page 184
- ▶ ›CD‹, refer to page 163
- ▶ ›CD changer‹, refer to page 165
- ▶ ›Notepad‹, refer to page 25
- ▶ ›DVD‹, refer to page 170

The Info Display, refer to page 24, will display either the equipment that you are now operating or any current error messages.

## Voice commands

### Voice command system activation

Briefly press the  button on the steering wheel.

An acoustic signal and the display "SVS active" on the Info Display, refer to page 24, indicate that the system is ready for operation. The system automatically starts in the main menu.

From here, you can call up all the equipment that can be operated.

### Canceling voice command

Briefly press the  button on the steering wheel

or

 ›Cancel‹.

In dialogs in which any text can be spoken, e.g. names, notes, canceling is only possible using the  button.

 The system automatically switches over to its telephone mode if you receive a call during voice input. "SVS active" appears on the Info Display, refer to page 24. ◀

### Voice commands

The voice command system operates on the basis of specific, predefined commands; these commands should be spoken precisely as indicated. You can have the possible commands read aloud at any point. To do so, say the command ›Options‹.

In addition to the commands described, there are often other commands that run the same function. Instead of ›Options‹, you can, for example, also say ›What now‹. In addition,

numerous options are often available, such as ›Scale 100 miles‹ instead of ›Scale‹.

### Short commands

In the ›Main menu‹ level, you can run certain functions directly with brief commands, refer to page 230, without having to open an equipment level first.

For example, if you want to dial a phone number, you can directly

- 1. ›Dial number‹.
- 2. Enter the phone number.

without previously opening

- ›Telephone‹

### Identification in Owner's Manual

Special commands are available for specific systems. In this Owner's Manual you will find these commands in the sections describing the individual systems.

- Operation with the voice command system is always indicated with this symbol.

### Displays on Info Display

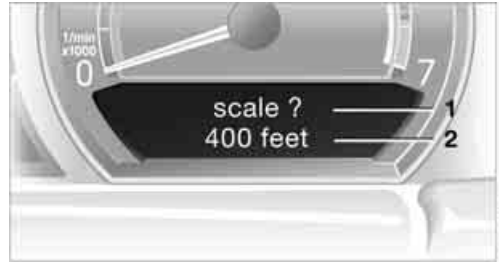

The Info Display shows you what the voice command system has understood in line 2, while also indicating which voice command or question is currently active in line 1. In addition, any error messages are also displayed.

### Changing map scale for navigation: an example

#### Starting the dialog

Briefly press the  button on the steering wheel.

You say	The voice command system replies	Shown on Info Display
		"SVS active"
›Change scale‹	››Please enter the desired scale‹‹	"scale? change scale"
›Scale 400 feet‹		"ok 400 ft"

## Adjusting volume

You can adjust the volume for the instructions from the voice command system:



Turn the knob during an instruction/announcement to select the desired volume.

Instructions/announcements from the voice command system will continue at this volume level, even if the other audio sources are set to minimum volume.

The volume setting is stored for the remote control currently in use.

## Notes

 Do not use the voice command system to make emergency calls. Your voice and habitual tone could be affected by stressful situations, as a result of which the process of establishing the telephone connection could be unnecessarily delayed. Instead, use the emergency call button near the interior rearview mirror, refer to page 219. ◀

## Environmental conditions

The voice command system uses a special hands-free microphone located in the front of your vehicle's headliner. Although the system is designed to filter out ambient noise, you can help ensure that your commands will be understood by observing the following instructions:

- ▶ Speak smoothly and clearly, at a normal volume. Avoid excessive emphasis and pauses.
- ▶ Do not speak while the voice command system is itself speaking.

- ▶ Keep the doors, windows and glass sunroof closed to prevent interference from ambient noise.
- ▶ Avoid other sources of noise in the vehicle while speaking, and ask other vehicle occupants to refrain from talking while you are using the system.
- ▶ The hands-free microphone is aimed toward the driver. This means that the system might not be able to register the voices of other vehicle occupants properly.

## The notepad

### Recording a note

 ›Record note◁.

You can store roughly ten minutes of spoken text, either as a single entry or as multiple entries of any desired length.

To stop recording:

Press the  button longer.

 When recording a note, the voice command system does not hear the command ›Cancel◁ or ›Exit◁. The text checking function for command words is deactivated in this case so that you can speak any desired text for your notes. This feature saves you from having to concentrate on avoiding any command words. ◀

### Listening to a notepad entry

To listen to recorded notepad entries:

-  1. ›Read out◁.  
Approximately the first 3 seconds of the first note are read aloud.
2. After the request ››Record note, read out note, delete note.◁◁ select the desired function.
- ▶ To listen to the entire note: ›Read out◁.
  - ▶ To listen to the next note: ›Next◁.
  - ▶ To listen to the note again: ›Back◁ or ›Repeat◁.

## Deleting notes

1. ›Edit‹.
2. ›Delete‹.

## Clearing notepad

To delete all contents from the notepad:

1. ›Notepad‹.
2. ›Delete‹.

## Standard commands

The standard commands available for use with all controlled systems are the same.



On delivery, the ›Standard dialog‹ is set so as to simplify familiarization with the voice command system. ◀

Function	Command
To repeat last message issued by the voice command system	›Repeat‹
To switch off the voice command system	›Cancel‹
To set comprehensive instructions and error reports	›Standard dialog‹
To set brief instructions and error reports	›Short dialog‹
To call up information on individual items of equipment	›Help‹
To have the system read aloud a list of the commands available for the selected system. This list simultaneously appears on the Info Display, refer to page 24	›Options‹
To open the main menu	›Main menu‹







## Controls

This chapter is intended to provide you with information for complete control of your vehicle. Its extensive array of features and accessories, provided both for driving and for your own safety, comfort and convenience, are described here.

# Opening and closing

## Remote control/key



- 1 Remote control with integrated key
- 2 Spare key
- 3 Adapter for spare key, in onboard tool kit, refer to page 213

### Remote control with integrated key

Each remote control contains a battery which is automatically charged in the ignition lock while driving. Use each remote control for an extended drive at least twice a year to keep the battery charged. For Comfort Access\*, the remote control contains a replaceable battery, refer to page 39.

Depending on which remote control is detected by the vehicle during unlocking, different settings are called up and carried out in the vehicle, refer to Key Memory on page 31.

Information on the required maintenance is also stored in the remote control, refer to CBS Condition Based Service, page 211.

## Integrated key



Press button 1 to release the key.

You can use the integrated key to lock and unlock the following:

- ▷ the storage compartment under the front armrest
- ▷ the driver's door
- ▷ the luggage compartment lid

Inside the storage compartment, you will also find the switch for locking the luggage compartment lid separately, refer to page 35.

If you then lock the storage compartment under the center armrest, refer to page 114, and only surrender the remote control, this will prevent unauthorized access to the vehicle through the luggage compartment lid. This is an advantage in a hotel, for example.

### New remote controls

New remote controls, additional or when lost, can be obtained from your BMW center.

### Spare key

Store the spare key in a safe place such as your wallet. This key is not intended for constant use.

The spare key and integrated key fit the same locks.



## Adapter for spare key

You will need the adapter to activate the ignition and to start the vehicle with the spare key.

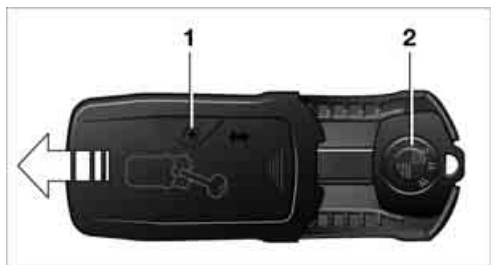

Take the adapter from the onboard tool kit, refer to page 213.

Press lock button 1, slide the cover open and insert the spare key 2 into the adapter. Close the cover and insert the adapter into the ignition lock.

## Key Memory

### The concept

You can set a number of functions of your BMW individually according to your preferences. Key Memory ensures that most of these settings are stored for the remote control currently in use without you having to do anything. When the vehicle is unlocked, the corresponding remote control is detected and the settings stored for it are called up and carried out.

This means that your BMW will return to your personal settings even if it has in the meantime been driven by another person with his/her own remote control and settings. The individual settings are stored for a maximum of four remote controls.

### Key Memory

- ▷ Personal temperature distribution for seat heating\*, refer to page 49.
- ▷ Personal setting for the programmable button on the steering wheel, refer to page 52.
- ▷ Personal setting of PDC Park Distance Control\*, refer to page 86.

- ▷ Air distribution, temperature, and intensity of the Automatic climate control, refer to page 105.
- ▷ Settings for the displays on the Control Display:
  - ▷ Units of measure for fuel consumption, distance traveled, distances to go, temperature, and pressure, refer to page 84.
  - ▷ Language on Control Display, refer to page 84.
  - ▷ Display format of date and time, refer to page 84.
  - ▷ Brightness of Control Display, refer to page 85.
- ▷ Personal settings for volume and tone of the Entertainment sound output, refer to page 153.
- ▷ Personal settings for the stored stations of the radio, refer to page 158.
- ▷ Personal settings for the volume of the hands-free telephone operation, refer to page 179.

## Central locking system

### The concept

The central locking system is ready for operation whenever the driver's door is closed. This simultaneously engages and releases the locks on the following:

- ▷ Doors
- ▷ Luggage compartment lid
- ▷ Fuel filler door

The central locking system can be operated from the outside:

- ▷ via the remote control
  - ▷ via the driver's door lock
  - ▷ with Comfort Access\* via the door handles
- and from inside via the button for the central locking system.

When the system is locked from inside, the fuel filler door remains unlocked. Refer to page 34.

Each time the central locking system is locked or unlocked from outside the vehicle, this simultaneously engages or disengages the anti-theft system. The alarm system is also armed or disarmed. The remote control also switches the interior lamps on and off.

For additional details on alarm system refer to page 37.

In an accident of corresponding severity, the central locking system automatically unlocks the vehicle. In addition, the hazard warning flashers and interior lamps switch on.

## Opening and closing: from outside

### Using remote control

 Persons or animals left unattended in a parked vehicle can lock the doors from the inside. For this reason, bring the remote control with you whenever you leave the vehicle so that you will always be able to unlock the vehicle from outside. ◀





- 1 Unlocking, comfort opening, and deactivating alarm system
- 2 Locking and securing, arming alarm system, switching off tilt alarm sensor and interior motion sensor, switching on interior lamps and perimeter lighting
- 3 Opening luggage compartment lid
- 4 Switching on interior lamps and pathway lighting, activating panic mode\*. You can find details about pathway lighting on page 100.

 If it is no longer possible to lock the vehicle with a remote control, its battery is discharged. Use this remote control during an extended drive; this will recharge the battery, refer to page 30.

In the event of malfunctions, please contact your BMW center, which is also your source for replacement keys. ◀

### Unlocking

1. Press the  button. The hazard warning flashers blink twice. Driver's door and fuel filler door are unlocked.
2. Press the  button again. All other doors and the luggage compartment lid are unlocked.

The interior lamps and the door-mounted perimeter lamps come on.

### Comfort opening

Press the  button longer. The windows and the glass sunroof open. The glass sunroof will not move if it is already in its raised position.

### Engaging locks

Press the  LOCK button. The hazard warning flashers blink once.

 Do not lock the vehicle from the outside when people are in it since they will be unable to unlock it from inside if they do not know the special procedure. ◀

### Switching on interior lamps and perimeter lighting

Press the  LOCK button if the vehicle is locked.

### Switching on interior lamps

Press the  button.

You can also use this function to locate your vehicle in parking garages etc.

## Panic mode\*

You can trigger the alarm system in case of danger:

Press the  button for at least 3 seconds.

To deactivate the alarm: press any button

## Opening luggage compartment lid

Press the  button for approx. one second.

The luggage compartment lid opens, regardless of whether it was previously locked or unlocked.

 During opening, the luggage compartment lid pivots back and up. Make sure there is adequate clearance available before opening.  
To avoid being inadvertently locked out, never set the remote control down in the luggage compartment. A previously locked luggage compartment lid is also locked again after closing. ◀

## Automatic luggage compartment lid operation\*

### Opening luggage compartment lid

Press the  button for approx. one second.

The luggage compartment lid opens all the way, regardless of whether it was previously locked or unlocked.

To interrupt the opening process:  
Press the button again while opening is in progress.

 During opening, the luggage compartment lid pivots back and up. Make sure there is adequate clearance available before opening.  
To avoid being inadvertently locked out, never set the remote control down in the luggage compartment. A previously locked luggage compartment lid is also locked again after closing. ◀

## Malfunction

Local radio waves can cause the remote control to malfunction.

Should the remote control fail to operate due to interference of this kind, the vehicle can be opened and closed with a key via the door lock.

If it is no longer possible to lock the vehicle with a remote control, then its battery is discharged. Use this remote control during an extended drive; this will recharge the battery, refer to page 30.

## For US owners only

The transmitter and receiver units comply with part 15 of the FCC/Federal Communication Commission regulations. Operation is governed by the following:

FCC ID:

- ▶ LX8766S
- ▶ LX8766E
- ▶ LX8CAS
- ▶ LX8CAS2

Compliance statement:

This device complies with part 15 of the FCC Rules. Operation is subject to the following two conditions:

- ▶ This device may not cause harmful interference, and
- ▶ this device must accept any interference received, including interference that may cause undesired operation.

 Any unauthorized modifications or changes to these devices could void the user's authority to operate this equipment. ◀

## Using the door lock

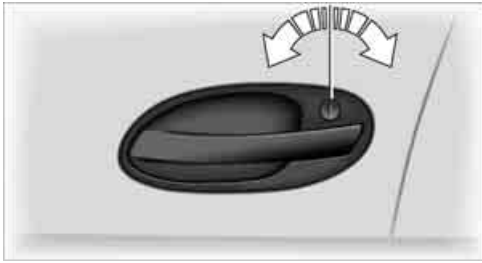

**⚠** Do not lock the vehicle from the outside when people are in it since they will be unable to unlock it from inside if they do not know the special procedure. ◀

1. Turn key.  
Driver's door and fuel filler door are unlocked.
2. Turn key again.  
All other doors and the luggage compartment lid are unlocked.

## Convenience operation

You also have the option of operating the windows and the glass sunroof from the driver's door lock.

- ▷ To open:  
With the door closed, turn the key to the Unlock position and hold it there.
- ▷ To close:  
With the door closed, turn the key to the Lock position and hold it there.

**⚠** Watch during the closing process to be sure that no one is injured. Releasing the key stops the operation. ◀

## Manual operation

If an electrical malfunction occurs, you can unlock or lock the driver's door with the key in the end positions of the door lock.

## Opening and closing: from inside



When the front doors are closed, use this button to unlock the doors and luggage compartment lid or to lock them without arming their anti-theft sensors. The fuel filler door remains unlocked.

**▶** If the remote control, refer to page 32, or Comfort Access, refer to page 38, have been used to unlock only the driver's door and you press the  button, then this unlocks all of the other doors, the luggage compartment lid, and the fuel filler door.

You can lock a closed driver's door by pressing . ◀

## Unlocking and opening doors

- ▷ Either unlock the doors together with the button for the central locking system and then pull the release handle above the armrest
- ▷ or pull the release handle for each door twice: the first pull unlocks the door, and the second one opens it.

**▶** When the low beams are switched on, the interior door handles are also lit. The intensity of the lighting is adjusted using the instrument lighting control, refer to page 101. ◀

## Engaging locks

- ▷ Use the central locking button to lock all of the doors simultaneously
- ▷ or press down the individual lock buttons of the doors.

To prevent the driver from being inadvertently locked out of the vehicle, the lock button on the driver's door automatically extends again after a brief period if the door remains open.

 Persons or animals left unattended in a parked vehicle can lock the doors from the inside. For this reason, bring the remote control with you whenever you leave the vehicle so that you will always be able to unlock the vehicle from outside. ◀

## Doors

### Automatic soft closing\*

Apply gentle pressure to the door to close it. The closing process will then be carried out automatically.

 To avoid injuries, make sure that the door's travel path is completely free and clear before closing. ◀

## Luggage compartment lid

### Opening from outside

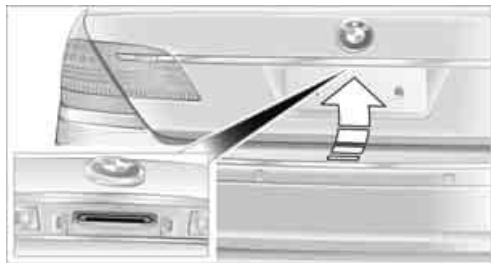

Press the button on the luggage compartment lid or the  button on the remote control for approx. 1 second: the luggage compartment lid opens.

 During opening, the luggage compartment lid pivots back and up. Make sure there is adequate clearance available before opening. ◀

## The lock



All of the vehicle's keys fit the luggage compartment lid lock located in the license plate recess.

### Opening separately

Insert the key into the luggage compartment lid's lock and turn it all the way to the right – the lid opens.

 To avoid being inadvertently locked out, never set the key or the remote control down in the luggage compartment. The luggage compartment is locked again as soon as you close the lid.

If you use the lock to unlock the luggage compartment lid while the alarm system is armed, the alarm will be triggered. To avoid this, you should unlock the vehicle first. If the alarm has been triggered accidentally, switch off the alarm, refer to page 37. ◀

### Locking separately



The location of the switch varies, depending on the individual vehicle's equipment.

- 1 Luggage compartment lid locked
- 2 Luggage compartment lid unlocked

Push the switch into position 1. This locks the luggage compartment lid and disconnects it from the central locking system.

If you then lock the storage compartment under the front center armrest, refer to page 114, and only surrender the remote control without the key, refer to page 30, for example when leaving the vehicle for valet parking, etc., this will prevent unauthorized access to the vehicle through the luggage compartment lid. This is an advantage in a hotel, for example.

## Manual operation

If an electrical malfunction occurs, refer to Opening separately on page 35.

## Opening from inside



You can use this button to open the luggage compartment lid when the vehicle is stationary. This is not possible if the luggage compartment lid has been locked separately.

## Closing



A recess has been incorporated into the inside trim on the luggage compartment lid to make it easier to pull down.

## Automatic soft closing

Apply gentle pressure to the luggage compartment lid to close it. The closing process will then be carried out automatically.

 Make sure that the closing path of the luggage compartment lid is clear; otherwise, injuries may result. ◀

## Automatic luggage compartment lid operation\*

### Opening

The luggage compartment lid opens completely when you:

- ▶ Press the button next to the steering column.
- ▶ Press the button on the outside of the luggage compartment lid, refer to page 35.
- ▶ Press the  button on the remote control, refer to page 33.

 During opening, the luggage compartment lid pivots back and up. Make sure there is adequate clearance available before opening. ◀

### Closing



The luggage compartment lid closes automatically when you:

- ▶ Press the button.
- ▶ Press the button on the outside of the luggage compartment lid, refer to page 35.

 The luggage compartment lid immediately stops opening or closing if you hold it in place by hand. ◀

 Make sure that the closing path of the luggage compartment lid is clear; otherwise, injuries may result. ◀

## Manual operation

In the case of an electrical malfunction, you can unlock the luggage compartment lid with the key, refer to page 35, and slowly open and close it without sudden movements.

## Emergency release



Pull the lever inside the luggage compartment. This unlocks the luggage compartment lid.

## Alarm system

### The concept

The vehicle alarm system responds to:

- ▷ opening of a door, the hood or the luggage compartment lid
- ▷ movement in the vehicle interior: interior motion sensor, refer to page 38
- ▷ changes in the vehicle's tilt if someone attempts to steal the wheels or tow the vehicle
- ▷ interruptions in battery voltage

The alarm system briefly indicates unauthorized tampering:

- ▷ with an acoustic alarm
- ▷ by switching on the hazard warning flashers
- ▷ by flashing the high beams

### Arming and disarming alarm system

When you lock or unlock the vehicle, either with the remote control or at the door lock, the alarm system is armed or disarmed at the same time.

When the alarm system is armed, you can also open the luggage compartment lid with the

button on the remote control, refer to page 33. When the luggage compartment lid is closed, it is relocked and monitored again.

Unlocking via the door lock will trigger the alarm on some national-market versions. Pressing the 'Panic mode' button for a longer period also triggers the alarm, refer to page 33. ◀

### Switching off alarm

- ▷ Unlock the vehicle using the remote control, refer to page 32.
- ▷ Insert the remote control into the ignition lock.

### Indicator lamp displays



- ▷ The indicator lamp below the interior rearview mirror flashes continuously: the system is armed.
- ▷ The indicator lamp flashes after the vehicle is locked: the doors or luggage compartment lid are not properly closed. Even if you do not close the door involved, the system begins to monitor the remaining areas, and the indicator lamp flashes continuously after 10 seconds. However, the interior motion sensor is not activated.
- ▷ After the vehicle is unlocked, the indicator lamp goes out: no manipulation or attempted intrusions have been detected in the period since the system was armed.
- ▷ After the vehicle is unlocked, the indicator lamp flashes until the remote control is inserted into the ignition lock, but for no more than roughly 5 minutes: an attempted entry has been detected in the period since the system was armed.

## Tilt alarm sensor

The tilt of the vehicle is monitored. The alarm system reacts, e.g. in case of an attempted wheel theft or towing.

## Interior motion sensor

In order for the interior motion sensor to function properly, the windows and glass sunroof must be completely closed.

## Avoiding unintentional alarms

The tilt alarm sensor and interior motion sensor may be switched off at the same time. This prevents unintentional alarms, e.g. in the following situations:

- ▷ In duplex garages
- ▷ During transport on car-carrying trains, boats/ships or on a trailer
- ▷ When animals are to remain in the vehicle

## Switching off tilt alarm sensor and interior motion sensor

Press the  LOCK button on the remote control again as soon as the vehicle is locked.

The indicator lamp lights up briefly and then flashes continuously. The tilt alarm sensor and the interior motion sensor are switched off until the next time the vehicle is unlocked and subsequently locked again.

## Comfort Access\*

With Comfort Access, you can have access to your vehicle without having to hold the remote control in your hand. It is sufficient to carry the remote control on your person, e.g. in a jacket pocket. The vehicle automatically detects the associated remote control inside the vehicle or in its immediate vicinity.

Comfort Access supports the following functions:

- ▷ Locking/unlocking the vehicle
- ▷ Unlocking the luggage compartment lid separately
- ▷ Starting the engine

## Functional requirements

- ▷ The vehicle can only be locked if the remote control is outside the vehicle.
- ▷ The next unlocking and locking cycle is not possible until after approx. 2 seconds.
- ▷ The engine can only be started if the remote control is inside the vehicle.

## Comparison to conventional remote control

You can control the functions mentioned previously with the Comfort Access or by pressing the buttons on the remote control. Therefore please first familiarize yourself with the instructions for opening and closing, starting on page 32.

The specific features involved in the use of Comfort Access are described below.

 If a short delay occurs when opening or closing the windows and the glass sunroof, then this indicates that the system is checking whether a remote control is located in the vehicle. Please repeat opening or closing if necessary. ◀

## Unlocking

Pull a door handle. This corresponds to pressing the  button.

 Only the door of the door handle you have pulled is unlocked.

You unlock the other doors from the inside, using the central locking system button, refer to page 34. ◀

## Locking

Push a door handle. This corresponds to pressing the  button.

 Before locking, make sure that the ignition and all current-consuming devices are switched off in order to minimize the drain on the battery.

If a remote control is detected in the interior, the vehicle is unlocked again or not locked in the first place. ◀



## Unlocking the luggage compartment lid separately

Press the button on the outside of the luggage compartment lid, refer to page 35. This corresponds to pressing the  button.

 If a remote control accidentally left in the luggage compartment is detected in the locked vehicle, then the luggage compartment lid opens again. ◀

## Radio ready state

By briefly pressing the Start/Stop button, you switch on the radio ready state, refer to page 57.

 When doing so, do not depress the brake pedal; otherwise, the engine will start. ◀

## Starting the engine

You can start the engine or switch on the ignition, as long as a remote control is in the passenger compartment. The remote does not have to be inserted into the ignition lock, refer to page 57.

## Before driving into a car wash

1. Insert remote control into ignition lock.
2. Shift transmission into position N.
3. Switch engine off.
4. Leave the remote control in the ignition lock.

The vehicle can roll.

## Malfunction

Local radio waves can disrupt the function of Comfort Access. Should the remote control fail to operate due to interference of this kind, you can respond by using the buttons on the remote control or by using a key to unlock or lock your vehicle at one of the doors. To start the engine after this, insert the remote control into the ignition lock.

## Changing battery

The remote control for Comfort Access contains a battery that must be replaced when it becomes discharged.

1. Remove the integrated key from the remote control, refer to page 30.
2. Press in the detent catch, refer to arrow 1, e.g. with the key.



3. Remove the cover of the battery compartment, refer to arrow 2.
4. Insert a battery of the same type with the positive side facing upwards.
5. Press the cover to close it.



Return used battery to a recycling collection point or to your BMW center. ◀

## Windows

 To prevent bodily injuries, watch the window as it closes. Always take along the remote control when you leave the vehicle; otherwise, children could, for example, operate the windows and injure themselves. ◀

## Opening, closing



- ▷ Press the switch down to the resistance point:  
The window continues to open as long as you continue to hold the switch.
- ▷ Press the switch beyond the resistance point:  
The window opens automatically. Press the switch again to stop the opening movement.

You can close the windows in the same manner by pulling the switch.

## After switching off ignition

You can still operate the power windows:

- ▷ For an extended period in radio ready state.
- ▷ For approx. 1 minute when the ignition is switched off or with the remote control disengaged.

To open, press the switch beyond the resistance point.

## Pinch protection system

If the closing force exceeds a specific value as a window closes, the closing action is interrupted and the window reopens slightly.

 Despite the presence of the pinch protection system, make sure to inspect the window's travel path prior to closing it, as the safety system might fail to detect certain kinds of obstructions, such as very thin objects, and the window would continue closing. Do not install any accessories in the range of movement of the windows; otherwise, the pinch protection system will be impaired. ◀

 When you close the windows they will slow down as they approach the end of their travel; this is to allow the pinch protection system to respond more precisely to any obstructions encountered in this critical range. ◀

## Closing without the pinch protection system

If danger outside the vehicle or a frozen window prevents you from closing the windows normally, proceed as follows:

1. Pull the switch past the resistance point and hold it there. The pinch protection system is restricted and the window opens slightly once the closing force exceeds a certain value.
2. Pull the switch again beyond the resistance point within approx. 4 seconds and hold it there. The window closes without the pinch protection system.

## Safety switch





With the safety switch, you can prevent the rear windows from being opened or closed via the switches in the rear passenger area, by children, for example.

The same is true for:

- ▷ the adjustment of the electrical rear seats, refer to page 45
- ▷ the adjustment of the electrical head restraints in the rear, refer to page 47
- ▷ the operation of the roller sun blind from the rear, refer to page 112

The LED lights up when this safety feature is activated.

 Press the safety switch when children ride in the rear; otherwise, unsupervised closing of the windows could lead to injuries. ◀

 In order to deactivate the function again, you must insert the remote control into the ignition lock or, with Comfort Access, you must switch into radio ready state. ◀

## Glass sunroof, electric\*

 To prevent bodily injuries, watch the glass sunroof as it closes.

Always take along the remote control when you leave the vehicle; otherwise, children could, for example, operate the roof and injure themselves. ◀

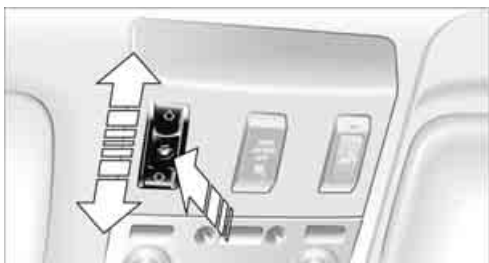

### Raising

Press the switch.

The closed glass sunroof is raised and the sliding visor opens slightly.

 Do not use force to close the sliding visor when the sunroof is in its raised position, as this could damage the mechanism. ◀

### Opening, closing

- ▷ Slide switch back to the resistance point. The glass sunroof and the sliding visor continue to open together for as long as you maintain pressure on the switch.
- ▷ Press the switch back briefly past the resistance point. The glass sunroof and the sliding visor open automatically. Pressing the switch again briefly stops the operation.

Close the glass sunroof in the same way by sliding the switch toward the front. The sliding visor remains open and can be closed by hand.

For convenience operation using the remote key or the door lock, refer to page 32 or 34.

### Automatic opening and closing

Press the switch briefly beyond the resistance point.

The following movements are also automated:

- ▷ Press the switch when the roof is open: the sunroof is completely raised.
- ▷ With the sunroof raised, press the switch briefly in the opening direction: the sunroof is opened completely.

Pressing the switch again briefly stops the operation.

### Pinch protection system

If the glass sunroof meets with resistance during closing after approximately the middle of the roof opening or when closing from the raised position, then the closing operation is interrupted and the glass sunroof opens again somewhat.

 Despite the presence of the pinch protection system, inspect the sunroof's travel path prior to closing it, as the safety system might fail to detect certain kinds of obstructions, such as very thin objects, and the sunroof would continue closing. ◀

### Closing without the pinch protection system

If there is danger outside, push the switch beyond the resistance point and hold it there. The roof closes without the pinch protection system.

### Following interruptions in electrical power supply

After a power supply interruption, it may only be possible to raise the sunroof. If this has occurred, have the system reinitialized. BMW recommends having this work carried out by your BMW center.

## Moving manually

In the event of an electrical malfunction, you can move the glass sunroof manually:

1. Take out the interior lamp, reach behind the opening, press out the cover.

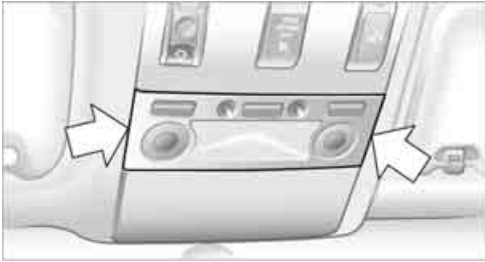

2. Insert the Allen wrench supplied with the onboard tool kit, refer to page 213, into the opening provided. Turn to slide the glass sunroof in the desired direction.

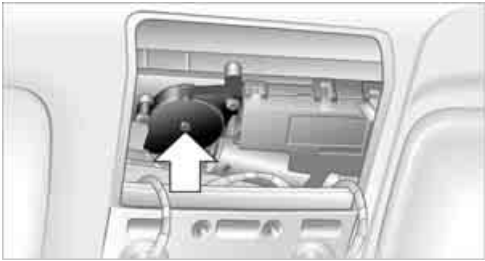

# Adjusting

## Sitting safely

The ideal sitting position can make a vital contribution to relaxed driving that is as fatigue-free as possible. Together with the safety belts and airbags, the sitting position plays an important role in the event of an accident. To ensure that the safety systems operate with optimized efficiency, we strongly urge you to follow the instructions contained in the section below.

For additional information on transporting children safely, refer to page 54.

## Airbags

 Always maintain an adequate distance between yourself and the airbags. Always hold the steering wheel by its rim with hands at the 9 o'clock and 3 o'clock positions to minimize the risk of injuries to your hands and arms in the event of airbag deployment. No one and nothing is to come between the airbags and the seat occupant.

Do not use the cover of the front airbag on the front passenger side as a storage area. Make sure that the front passenger is sitting correctly and does not rest feet or legs on the dashboard; otherwise, leg injuries can occur if the front airbag is triggered. Make sure that occupants do not rest their head against the side or head airbag; otherwise, injuries can occur if the airbags are triggered. ◀

Even if you follow all of the instructions, injuries resulting from contact with airbags cannot be entirely ruled out, depending on the circumstances. The ignition and inflation noise may provoke a mild – usually temporary – hearing loss in extremely sensitive individuals.

For airbag locations and additional information on airbags, refer to page 95.

## Head restraint

A correctly adjusted head restraint reduces the risk of injury to cervical vertebrae in the event of an accident.



Adjust the head restraint so that its center is approx. at ear level. Otherwise, there is increased danger of injury in the event of an accident. ◀

Adjusting the head restraint, refer to page 46.

## Safety belt

Fasten safety belts on all occupied seats before every trip. Although airbags enhance safety by providing added protection, they are not a substitute for safety belts.

Your vehicle has five seats that are each equipped with a safety belt.



Never allow more than one person to wear a single safety belt. Never allow infants or small children to ride on a passenger's lap. Make sure that the belt lies low around the hips in the lap area and does not press on the abdomen. The safety belt must not lie across the neck, rub on sharp edges, be routed over solid or breakable objects or be pinched. Wear the safety belt without twisting, snugly across the lap and shoulders, as close to the body as possible. Otherwise, the belt can slip over the hips in the lap area in a frontal impact and injure the abdomen. Avoid wearing clothing that prevents the belt from fitting properly and pull the shoulder belt periodically to readjust the tension across your lap in order to avoid a reduction in the retention effect of the safety belt. ◀

For instructions on operating safety belts, refer to page 48.

## Seats

### Note before adjusting



Never attempt to adjust your seat while operating the vehicle. The seat could respond with unexpected movement and the ensuing loss of vehicle control could lead to an accident.

Also on the passenger side, do not recline the backrest too far to the rear while the vehicle is being driven; otherwise, there is a danger in the event of an accident of 'sliding under' the safety belt, eliminating the protection normally provided by the belt. ◀

Please note the information on damage to safety belts provided on page 49 and the information on the active head restraints on page 47.

## The concept



You adjust the seat in two stages:

- 1 Preselect the function: the button lights up brightly
- 2 Adjustments: control knob
  - ▷ slide forward or back ◀▶
  - ▷ slide up or down ▲▼
  - ▷ turn ▶◀

## Seat adjustment

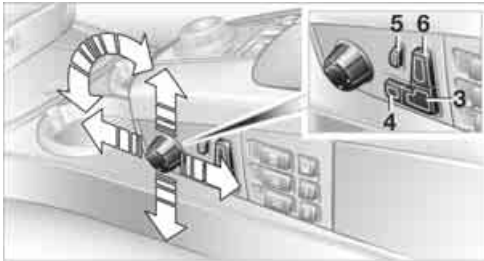

You can use the control knob to adjust the settings after selecting the desired function with the buttons.

**!** To ensure that the safety systems continue to provide optimized protection,

please follow the adjustment instructions on page 43. ◀

- 3 Forward and back: ◀▶  
Height: ▲▼  
Backrest: ▶◀  
This button is basically always active.
- 4 Thigh support: ◀▶  
Height: ▲▼  
Tilt: ▶◀
- 5 Lumbar support\*, refer to Lumbar support adjustment
- 6 Height of the head restraint: ▲▼

## Front comfort seat\* adjustment

With this seat, you can also adjust:

- 5 Backrest width: increase or decrease lateral support ▶◀
- 6 Shoulder support, refer to Shoulder support adjustment  
Backrest: ▶◀

## Automatic backrest width adjustment

The backrest automatically moves to the widest possible position to make it easier to enter and exit the vehicle, before then returning to the standard position or the stored memory setting.

This automatic system is influenced on each of the two seats by their respective door, as well as on the driver's seat, by the ignition and on the front passenger's seat, by the safety belt buckle.

## Lumbar support adjustment

- 5 Lumbar support

You can also adjust the contour of the backrest to obtain additional support in the lumbar region.

The upper hips and spinal column receive supplementary support to help you maintain a relaxed, upright sitting position.

- ▷ ◀▶ Increase or decrease curvature
- ▷ ▲▼ Shift curvature up or down

## Shoulder support adjustment

6 Adjustment of the tilt angle of the shoulder support: ◀▶

The shoulder support provides support to your back in the shoulder region as well. This provides a relaxed driving position and helps relieve stress on the shoulder muscles.

## Rear comfort seat\* adjustment

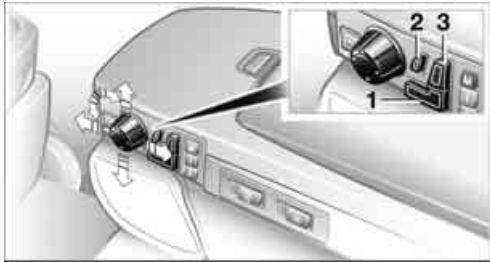

You can use the control knob to adjust the settings after selecting the desired function with the buttons.

1 Forward and back: ◀▶

Tilt: ▲▼

Backrest: ▶◀

This button is basically always active.

2 Lumbar support, refer to Lumbar support adjustment

3 Shoulder support: ◀▶

Height of head restraint: ▲▼

Backrest: ▶◀

 It is not possible to adjust the comfort seats if the safety switch for the power windows has been pressed, refer to page 40. ◀

## Adjusting passenger seat from rear

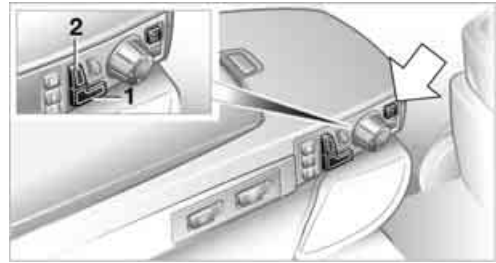

The front passenger's seat can be adjusted from the rear sitting positions, for instance, when a rear passenger desires more legroom. Press the button to activate this function, refer to arrow.

You can use the control knob to adjust the settings after selecting the desired function with the buttons.

1 Forward and back: ◀▶

Height: ▲▼

Tilt: ▶◀

2 Height of head restraint: ▲▼

Backrest: ▶◀

Press the button again, refer to arrow, to deactivate this function.

## Resetting to standard position

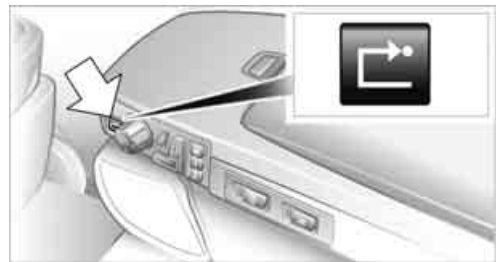

You can use this button to return the rear seats to their standard positions. Maintain pressure on the button until the system completes the adjustment.

 The rear seats must be returned to their standard position before using a child restraint system, refer to page 54. ◀

## Seat, mirror and steering wheel memory

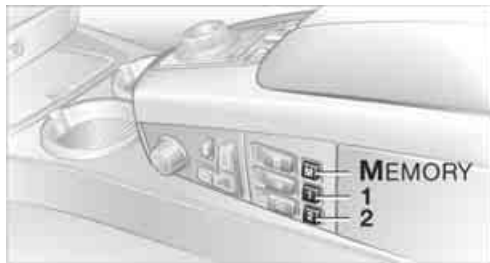

You can store and select two different adjustment settings for the driver's seat, exterior mirrors and steering wheel.

With comfort seats, you can also use the memory to store and recall two seat positions for each additional seat.

The adjustment of the lumbar support is not stored in the memory.

### Storing

1. Switch on radio ready state or ignition, refer to page 57.
2. Set desired seat position; for driver's seat also set the exterior mirror and steering wheel position.
3. Press **MEMORY** button:  
The LED in the button lights up.
4. Press the desired memory button **1** or **2**:  
The LED goes out.

### Requesting

 Do not request a position from the memory while the vehicle is moving. There is a risk of accident from unexpected movement of the seat or steering wheel. ◀

### Comfort mode

1. With driver's door open after unlocking or with radio ready state switched on.
2. Briefly press the desired memory button **1** or **2**.

The adjusting procedure is immediately interrupted when you touch a seat adjustment switch or one of the memory buttons.

### Safety mode

1. With driver's door closed and ignition switched either on or off.
2. Press the desired memory button **1** or **2** and maintain pressure until the adjustment process has been completed.

If you press the **MEMORY** button accidentally: Press the button again; the LED goes out.

## Head restraints

A correctly adjusted head restraint reduces the risk of injury to cervical vertebrae in the event of an accident.

 Adjust the head restraint so that its center is approx. at ear level. Otherwise, there is increased danger of injury in the event of an accident. Only remove the head restraint if no one will be sitting on the seat in question. Reinstall the head restraint before transporting anyone in the seat. Otherwise, the protective function of the head restraint is unavailable. ◀

### Front: height adjustment



1. Select head restraint, button **1**.
2. Adjust height, arrow **2**.

### Removing

1. Raise head restraint all the way.
2. Pull out the head restraint all the way out with a firm tug.



## Installing

1. Press the button upward, refer to arrow **2**, for a maximum of approx. 10 seconds, but if possible, only until the humming sound changes, indicating that the mounting socket has reached the top.
2. Insert the head restraint and press down until you hear and feel it engage on both sides.

## Front: tilt angle adjustment



Tilt the head restraint.

 With the comfort seat, adjust the distance to the back of the head via the shoulder support adjusting button, refer to page 45. ◀

## Front: side extensions adjustment



You can fold the side extensions on the head restraint forward for increased lateral support in the resting position.

## Front head restraints, active\*

The comfort seats are equipped with an active head restraint.

In the event of a rear-end collision of corresponding severity, the active head restraint reduces the distance from the head.

 Do not use seat or head restraint covers and do not hang objects, e.g. clothes hangers, on the head restraints or attach any accessories to the seat or head restraint. Otherwise, the protective function of the active head restraint will be impaired and personal safety endangered. ◀

## Rear: height adjustment

### Mechanically

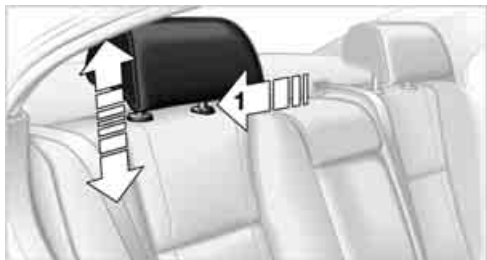

- ▷ To raise: pull.
- ▷ To lower: press the button, arrow **1**, and slide the head restraint downward.

Removing:

1. Pull the head restraint upward till it reaches the stop.
2. Press the button, arrow **1**, and pull the head restraint all the way out.

### Electrically\*

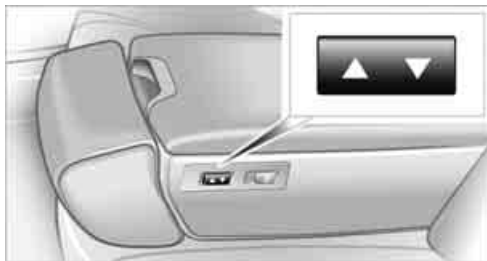

The head restraints at the outer sitting positions extend automatically whenever a passenger in the rear seat fastens his safety belt. You can also adjust the height of the head restraint electrically.

 To prevent possible personal injury and property damage, always ensure that the area above the head restraints is clear and unobstructed before extending them upward. ◀

 You can use the safety switch, refer to page 40, to deactivate the height adjustment of the head restraints. ◀

Removal and installation: the same as with the front head restraints.

## Middle head restraint

 Pull out the lowered head restraint until it engages before the center rear seat is occupied. Otherwise, the level of occupant protection can be reduced. ◀

## Rear: side extension adjustment\*



You can fold the side extensions on the head restraint forward for increased lateral support in the resting position.

## Safety belts

 To ensure that the safety systems continue to provide optimized protection, please follow the adjustment instructions on page 43. ◀

Fasten safety belts on all occupied seats before every trip. Although airbags enhance safety by providing added protection, they are not a substitute for safety belts.



## Fastening

Make sure you hear the latch plate engage in the belt buckle.

## Releasing

1. Hold the belt firmly.
2. Press the red button in the belt buckle.
3. Guide the belt back into its reel.

The shoulder strap's anchorage point will be in the correct position for adults of every build if the seat is correctly adjusted, refer to page 43.

The two rear safety belt buckles integrated into the rear seat are for passengers sitting on the left and right. The belt buckle embossed with the word CENTER is intended exclusively for use by passengers riding in the center position.

## Safety belt reminder for front seats



The indicator lamp flashes or lights up. In addition, a signal sounds. Please make sure that the safety belts are positioned correctly.

The safety belt reminder is active at speeds above approx. 5 mph/8 km/h. It can also be activated if objects are placed on the passenger's seat.

## Damage to safety belts

 In case of strain due to an accident or damage, replace the belt system including the safety belt tensioners and have the belt anchor points checked. Have this work done only by your BMW center or at a workshop that works according to BMW repair procedures with correspondingly trained personnel. Otherwise, there can be no guarantee that the safety devices will function properly. ◀

## Seat heating\*

### Front



The temperature setting progresses one step through its control sequence each time you press the button.

The maximum temperature is supplied when three lights are lit.

To switch off:

Press and hold the button.

### Temperature distribution

The heating action in the seat cushion and backrest can be distributed in different ways.

iDrive, for principle details, refer to page 16.

1. Press the **MENU** button to open the start menu.
2. Move the controller toward "Climate".

3. If need be, select the  symbol and press the controller to switch to the second page of the menu.

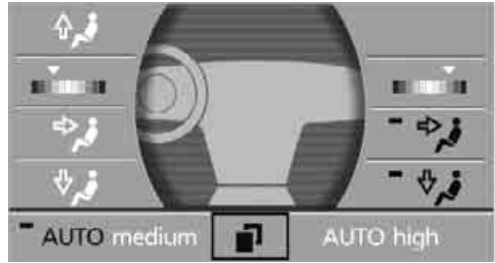

4. Select "Seat temp." and press the controller.
5. Select "Left" or "Right" and press the controller.

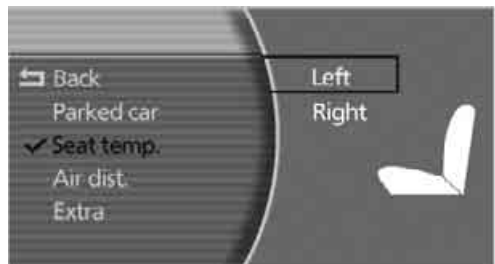

6. Turn to adjust the temperature distribution in the seat cushion and backrest and press the controller.

The setting is stored for the remote control currently in use.

### Rear



Operates the same as front seat heating, but without temperature distribution.

## Active seat ventilation\*

### Front



The system progresses one step through the control sequence each time you press the button.

To switch off:

Press and hold the button.

 The maximum setting with three lights is used for rapid cooling, e.g. if the vehicle has been parked in the sun. After a short time, the system automatically shifts down one step in order to prevent excessive cooling. ◀

### Rear

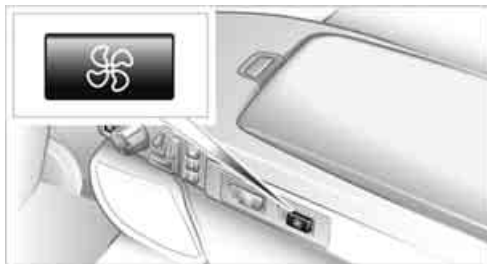

The operating concept is the same as for the front seat ventilation.

## Active seat for driver\*



Active adjustment of the seat cushion's contours reduces muscular tension and fatigue to help prevent lower back pain.

Press the button to switch on; the LED lights up.

## Mirrors

### Exterior mirrors

The mirror on the passenger's side is more curved than the driver's mirror.

 Objects reflected in the mirror are closer than they appear. Do not estimate the distance of following traffic based what you see in the mirror, as this will increase your risk of accident. ◀



- 1 Adjusting
- 2 Switching to the other mirror or automatic curb monitor, refer to Tilting down passenger-side exterior mirror on page 51
- 3 Folding mirrors in and out\*

Storing the mirror positions, refer to Seat, mirror and steering wheel memory on page 46.

## Adjusting manually

You can also adjust the mirrors manually by pressing against the outer edges of their mirror glass.

## Folding mirrors in and out\*

At driving speeds up to approx. 15 mph/ 20 km/h, you can fold the mirrors in and out by pressing button **3**. This is an advantage, e.g. in car washes and narrow streets, or for moving mirrors that were manually folded in back into the correct position.

**⚠** Before entering an automatic car wash, fold in the exterior mirrors by hand or with button **3**, to prevent them from being damaged due to the width of the vehicle. ◀

## Automatic heating

Both exterior mirrors are automatically heated whenever the ignition is switched on.

## Tilting down passenger-side exterior mirror – automatic curb monitor

### Activating

1. Push the mirror selector switch into the driver's mirror position, arrow **1**.



2. Engage transmission position R. The mirror glass tilts downward somewhat on the passenger's side. This allows the driver to see the area immediately adjacent to the vehicle – such as a curb – when parking, etc.

### Deactivating

Push the mirror selector switch into the passenger's mirror position, arrow **2**.

## Interior and exterior mirrors, automatic dimming feature\*

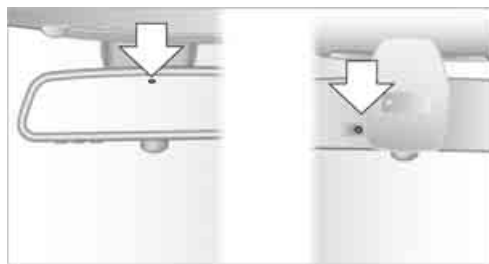

Two photocells in the interior rearview mirror control this function. One is integrated into the mirror's lens, the other is located off-set from this on the rear of the mirror housing.

For trouble-free operation, keep the photocells clean and do not cover the area between the interior rearview mirror and the windshield. Do not attach any kind of stickers to the windshield in front of the mirror either.

## Illuminated vanity mirror in rear

1. Press button **1**. The vanity mirror folds down.
2. Pull the mirror downward slightly before pivoting it.

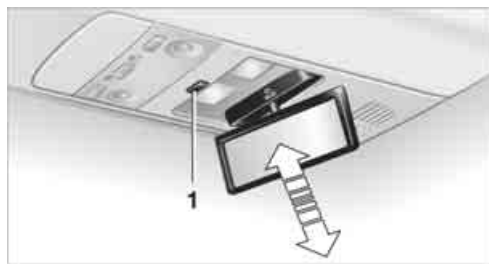

3. Before folding mirror in, straighten it out and then press upward.

## Steering wheel adjustment

**⚠** In order to prevent the risk of accident due to an unexpected movement, do not adjust the steering wheel while the vehicle is moving. ◀



The steering wheel can be adjusted in four directions.

To save steering wheel positions, refer to Seat, mirror and steering wheel memory on page 46.

## Assistance getting in and out

To make it easier to enter and exit the vehicle, the steering wheel temporarily moves into the top and front position.

This automatic feature is governed by the driver's door and the ignition switch.

## Steering wheel heater\*

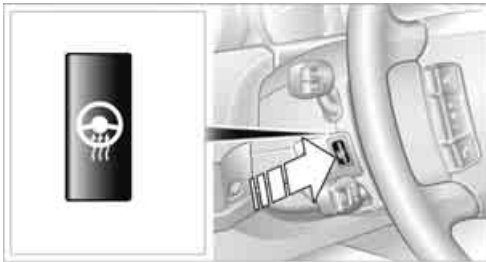

Press the button.

When the steering wheel heater is operating, the LED in the button lights up.

## Programmable buttons

You can individually program the button on the steering wheel and the button next to the controller.

iDrive, for principle details, refer to page 16.

1. Press the **MENU** button to open the start menu.
2. Move the controller toward "Settings".

3. Select "Vehicle" and press the controller.
4. Select "◊ button" or "◊ button". Continue to press the controller until the desired function appears.

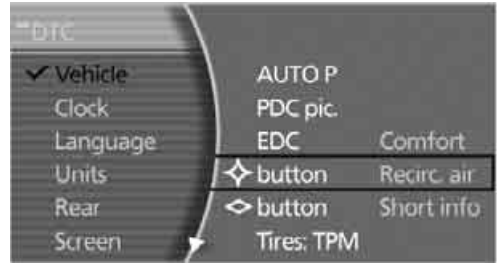

- ▷ "Recirc. air"  
The supply of outside air is shut off continuously, refer to Automatic recirculated air control/recirculated air mode on page 105.
- ▷ "Navi info"  
To repeat the most recent navigation system instruction, refer to Route guidance by voice instructions on page 146.
- ▷ "Short info"  
Display of the help and supplementary texts of the active menu for approx. 10 seconds, refer to page 21.



The "◊ button" can also be programmed with the following functions:

- ▷ "AUTO P"  
Activation/deactivation, refer to page 59.
- ▷ "NIGHT VISION"  
BMW Night Vision activation and deactivation, refer to page 98.

Rear seat screen\*:

- ▷ "Mode"  
You can choose between the output sources radio, CD player, and CD changer. It is necessary for one of these sources to have been activated.
- ▷ "FM" and "AM"  
Switching between the FM and AM wavebands, also refer to page 152.

## Operating function

Press the  button on the steering wheel or the  button next to the controller.

 If you program the button on the steering wheel with "AUTO P", you can conveniently activate and deactivate Automatic Hold with the button, e.g. during parking. Details on Automatic Hold are provided starting on page [59](#). ◀

The setting of the  button on the steering wheel is stored for the remote control currently in use.

# Transporting children safely

## The right place for children

**⚠** Do not leave children unattended in the vehicle; otherwise, they could endanger themselves and other persons, e.g. by opening the doors. ◀

### Children always in the rear

Accident research shows that the safest place for children is in the back seat.

**⚠** Children younger than 13 years of age or with a height under 5 ft/150 cm may only be transported in the rear in child restraint systems which correspond to the age, weight and height of the child. Otherwise, there is an increased danger of injury in an accident. ◀

Children 13 years of age or older must wear a safety belt as soon as a suitable child restraint system can no longer be used due to their age, size, and weight.

### Exception for front passenger seat

**⚠** Should it be necessary to use a child restraint system on the front passenger seat, the front, knee and side airbag on the front passenger side must be deactivated. Otherwise, there is an increased risk of injury for the child if the airbags are triggered, even with a child restraint system. ◀

More information on Automatic deactivation of front passenger airbags, refer to page 95.

## Installing child restraint systems

**⚠** Follow the child restraint system manufacturer's instructions when selecting, installing and using child restraint systems. Otherwise the protective effect may be diminished. ◀

### In the front passenger seat

**⚠** Before installing a child restraint system in the front passenger seat, make sure that the front, knee, and side airbags on the passenger side are deactivated. Otherwise, there is an increased risk of injury when the airbags are triggered. ◀

### Backrest width\*

**⚠** The passenger seat backrest width setting must be open all the way. After installing the child's seat, no memory position may be called up; otherwise, the stability of the child's seat on the front passenger seat is reduced. ◀

1. Open backrest width completely, refer to Front comfort seat adjustment on page 44.
2. Mount child's seat.

### Child seat security



All rear safety belts and the safety belt for the front passenger can be locked against pulling out to secure child restraint systems.

### Locking safety belt

1. Secure the child restraint system with the belt.
2. Pull out the belt webbing completely.
3. Allow the belt webbing to be pulled in and pull taut against the child restraint system. The safety belt is locked.



## Unlocking safety belt

1. Open the belt buckle.
2. Remove the child restraint system.
3. Allow the belt webbing to be pulled in completely.

## LATCH child restraint fixing system\*

LATCH: Lower Anchor and Tethers for CHildren.

 For installation and use of LATCH child restraint systems, follow the operating and safety instructions of the system manufacturer. ◀

If the vehicle is equipped with power seats in the rear, return these to their standard positions before using LATCH child restraint systems, refer to page 45.

Before installing the LATCH child's seat, pull the belt away from the region of the child restraint fixing system.

 Make sure that the LATCH anchors have properly engaged and that the child restraint system is resting snugly against the backrest. ◀

### Rear seats



The anchor points for the LATCH anchors are provided at the locations indicated by the arrows, in the gap between the bottom seat cushion and backrest.

## Installation guide

The installation guide makes it easier to install the LATCH child restraint systems and at the same time protects the surface of the seats.

 The installation guide is available at your BMW center. Always follow all instructions for operation and use provided by the manufacturer in the installation guide. ◀

Firmly press the installation guide into the gap between the upholstery on seat cushion and backrest, continuing until the two funnel-shaped guides snap into place in the LATCH child restraint fixing system in the seat.

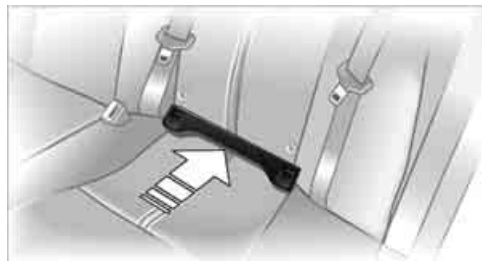

Pull the installation guide to remove.

## Child restraint system with tether strap

 The attachment points for the top tethers are only intended for attachment of child restraint systems; other uses can damage the attachment points. ◀

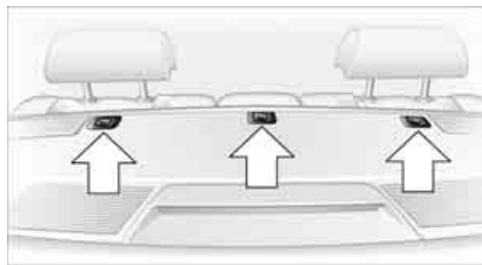

There are three additional attachment points for child restraint systems with a tether strap, refer to arrows.

## Routing of the tether strap

**⚠** Make sure that the tether strap is not routed over sharp edges and does not twist on its way to the attachment point; otherwise, the belt can fail to properly secure the child restraint system in the event of an accident. ◀

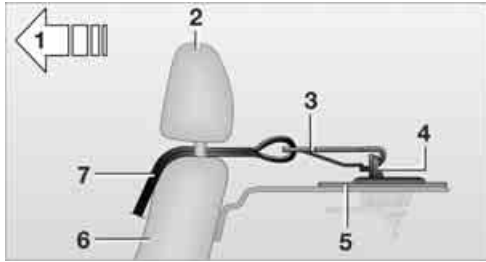

- 1 Direction of travel
- 2 Head restraint
- 3 Tether strap hook
- 4 Attachment point
- 5 Rear shelf
- 6 Backrest
- 7 Tether strap of child restraint system

Fold upward before using the mounting points.

1. Pull the head restraint upward.
2. Guide the tether strap between the supports of the head restraint.
3. Attach the tether strap hook to the attachment point.
4. Slide the head restraint into the bottom position.
5. Pull tether strap tight.

## During trips

**⚠** If the vehicle is equipped with rear side airbags, make sure that children riding in the rear do not lean out of the child's seat toward the door panels. Otherwise, injuries can occur if the side airbags are triggered. ◀

## Child-safety locks for rear doors

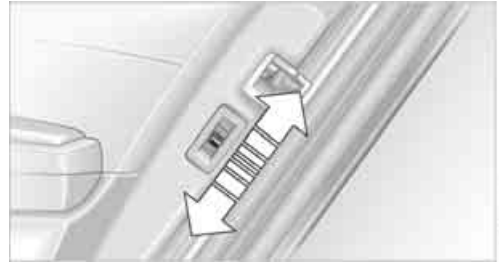

Slide down the safety levers on the rear doors:  
The door can now be opened from the outside only.

## Safety switch for power windows and rear seats

If the vehicle is equipped with power seats in the rear, return these to their standard adjustment setting before using a child restraint fixing system, refer to page 45.

When children are riding in the back, press the safety switch for the power windows, refer to page 40.

This switch also disables the power rear seat adjustment.

**⚠** Incorrect or unsupervised adjustment of the power seats in the rear could lead to bodily injury or damage to the child restraint system. ◀

## Ignition lock



Insert the remote control all the way into the ignition lock. Radio ready state is switched on. Individual electrical devices are ready for use.

## Start/Stop button

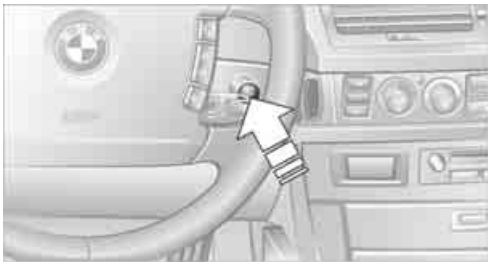

Briefly pressing the Start/Stop button several times switches the radio ready state or the ignition on and off.

 Briefly pressing the Start/Stop button with the brake pedal depressed starts the engine. ◀

## Radio ready state

Individual electrical devices are ready for use. The time and outside temperature appear on the Info Display.

## Ignition switched on

All vehicle systems are ready for operation.

 When the engine is not running, please switch off the ignition and nonessential

current-consuming devices in order to minimize the drain on the battery. ◀

## Ignition off

All of the indicator lamps on the Info Display go out. Only the selector lever indicator of the automatic transmission is still briefly displayed.

## Starting engine

 Do not run the engine in closed rooms; otherwise, the inhalation of toxic exhaust gases can cause unconsciousness and death. The exhaust gases contain carbon monoxide, an odorless and colorless, but highly toxic gas. Never leave an unattended vehicle with the engine running, as such a vehicle represents a potential safety hazard.

To prevent the vehicle from rolling, always move the selector lever into position P and engage the parking brake before leaving the vehicle with the engine running. ◀

 Avoid frequent starts in rapid succession or repeated starting attempts in which the engine does not start. Otherwise, the fuel is either left unspent or is insufficiently burned and there is a risk of overheating and damaging the catalytic converter. ◀

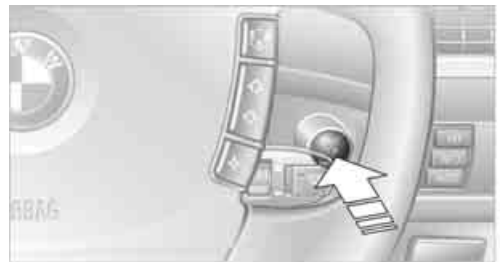

1. Depress brake pedal.
2. Briefly press the Start/Stop button.

When starting the engine, do not press the accelerator pedal.

Do not allow the engine to warm up by leaving it running while the vehicle remains stationary. Instead, start driving right away, at a moderate engine speed.

## Switching off engine

 When leaving the vehicle, always take the remote control with you. ◀

With the vehicle stationary, briefly press the Start/Stop button. Radio ready state is switched on.

The transmission automatically shifts to position P: interlock.

## Before driving into a car wash

To permit the vehicle to roll, take the following steps:

1. With Comfort Access: insert remote control into ignition lock.
2. Shift transmission into position N.
3. Switch engine off.
4. Leave the remote control in the ignition lock.

The transmission will shift into position P:

- ▷ automatically after approx. 30 minutes
- ▷ if you remove the remote control from the ignition lock

Pay attention to the messages on the Info Display.

## Removing remote control from ignition lock

Press in the remote control briefly; it pops partway out. This procedure will also switch off the ignition if it is on.

## Comfort function

To switch off the engine when the vehicle is stationary, press the Start/Stop button for longer than approx. 2 seconds. The remote control pops partway out.

## Parking brake

### The concept

Your BMW is equipped with an electromechanical parking brake.

The parking brake is primarily intended to prevent the vehicle from rolling while parked.

You can use the parking brake in two ways:

- ▷ Manually, by briefly pressing the button
- ▷ Automatically, by activating the Automatic Hold mode, refer to page 59

An electrohydraulic mechanism then engages the parking brake to prevent the rear wheels from turning whenever you switch off the engine.

When the engine is running, parking brake engagement is controlled by the brake system's hydraulic circuits, which act on the disc brakes in the front and rear wheels.

### Brake pedal feel

The hydraulic brake system can produce a slightly different braking feel. Engagement may also be accompanied by activation noise – this is normal.

### Manual engagement



Briefly press the button, the word PARK appears on the Info Display.

When the parking brake is engaged, the indicator lamp (P) on the Info Display lights up red, refer to page 12.

The remote control does not have to be inserted into the ignition lock for the parking brake to be set.

It is only possible to disengage the parking brake with the ignition on.

If exceptional circumstances should make it necessary to engage the parking brake while the vehicle is in motion, maintain pressure on the button.

The indicator lamp on the Info Display lights up in red, a chime sounds, and the brake lamps light up.

The vehicle continues to brake forcefully for as long as you maintain pressure on the button. When you brake the vehicle almost to a stop, i.e., down to a speed of approximately 2 mph/ 3 km/h or below, the parking brake remains engaged.

## Manual release

Briefly press the button with the ignition switched on.

The indicator lamp (P) on the Info Display goes out.

 As long as the remote control is inserted into the ignition lock, you can also release the parking brake after the engine has been switched off. This function is useful, for example, in automatic car washes, refer to page 123 ◀

 When leaving the vehicle, always bring the remote control with you; this precaution prevents children from disengaging the parking brake, for example. ◀

## Automatic Hold

You can activate the system after starting the engine; it then remains operational until the next time the engine is switched off.

This feature provides additional assistance during vehicle operation by automatically engaging and releasing the parking brake during stops at traffic lights, in stop-and-go traffic, etc. The vehicle is automatically held in place so as to suppress the tendency to creep when the transmission is in drive.

It also prevents the vehicle from rolling backward during uphill starts.

The parking brake engages automatically when you stop the vehicle and switch off the engine.

You can activate or deactivate Automatic Hold via the "Settings" menu in iDrive.

## Activation/deactivation

iDrive, for principle details, refer to page 16.

1. Press the **MENU** button to open the start menu.
2. Move the controller toward "Settings".
3. Select "Vehicle" and press the controller.
4. Select "AUTO P". Press the controller to activate/deactivate the desired function.

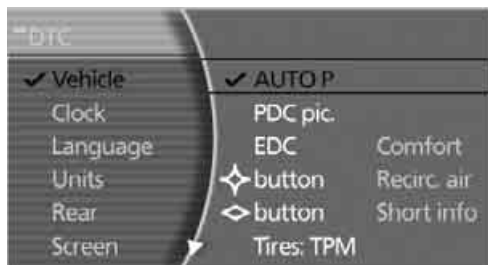

- ▶ Automatic Hold is activated.  
The green AUTO P status message on the Info Display indicates that the system is ready for operation.
- ▶ Automatic Hold is deactivated.  
The green AUTO P status message disappears from the Info Display.

 You can program the programmable button on the steering wheel with the Automatic Hold function, refer to page 52. This gives you the option of being able to quickly activate or deactivate Automatic Hold without distracting your attention from the road. ◀

## Driving

The parking brake engages automatically when the vehicle comes to a stop.

The indicator lamp (P) on Info Display lights up green.

To start off again, simply press the accelerator pedal. The parking brake is released automatically; the indicator lamp goes out.

 Do not drive through an automatic car wash with the Automatic Hold on and the engine running. Otherwise, the system will

engage the parking brake the moment the vehicle comes to a stop. ◀

## Parking

The parking brake engages automatically when you stop the vehicle and switch off the engine. The indicator lamp (P) changes from green to red.

 You can also release the parking brake manually after the engine is switched off, as long as the remote control is in the ignition lock, refer to page 59. You can use this function, for example, in a car wash. Automatic Hold is deactivated. ◀

 When leaving the vehicle, release the remote control from the detent in the ignition lock; this precaution prevents children from disengaging the parking brake etc. ◀

## For your safety

Automatic Hold is automatically deactivated when:

- ▷ the engine is switched off
- ▷ the system detects that the driver's seat is not occupied while the engine is running
- ▷ the hood is opened while the engine is running
- ▷ the luggage compartment is opened while the engine is running and the transmission is in reverse
- ▷ and when the parking brake is used to brake the vehicle to a stop during driving

The indicator lamp (P) changes from green to red, and the indication AUTO P on the Info Display disappears.

Before starting off again, briefly press the button to disengage the parking brake manually, refer to page 59, or reactivate Automatic Hold, refer to page 59.

 Before leaving the vehicle with the engine running, always move the automatic transmission's selector lever to position P and make sure that the parking brake is engaged. The vehicle could start to roll if you fail to take these precautions. ◀

 Automatic Hold is automatically deactivated whenever the system detects any tendency for the wheels to spin in response to slippery road surfaces.

Pay attention to the messages on the Info Display. For additional information, refer to Check Control on page 80. ◀

## Releasing parking brake manually

In the event of an electrical power loss or electrical malfunction, you can release the parking brake manually.

 Before manually releasing the parking brake and each time you park the vehicle without engaging the parking brake, make sure that the automatic transmission is in position P, refer to page 62. Be sure to pay attention to the information on the Info Display.

If circumstances should force you to park on a steeply inclined road surface, it is essential to take additional precautions against inadvertent rolling, e.g. by using the chock, refer to page 216. Otherwise, there is the danger of the vehicle rolling, depending on the incline. ◀

If it becomes necessary to also unlock the transmission lock of the automatic transmission, follow this sequence:

1. If necessary, start by releasing the parking brake manually.
2. Then release the automatic transmission's transmission lock manually, refer to page 64.

Jump starting and tow starting information, refer to section starting on page 220.

## What you will need

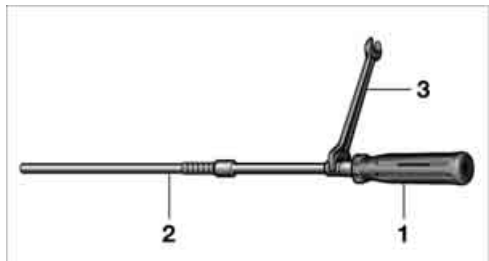

- 1 Screwdriver handle
- 2 Unlocking tool
- 3 10 mm open-end wrench

You will find the required tools in the onboard tool kit mounted on the inside of the luggage compartment lid, refer to page 213.

Insert the release tool into the screwdriver handle as shown in the illustration.

## Releasing



1. Remove the floor mat and the cover above the spare tire.
2. With the attached screwdriver handle, insert the release tool into the opening, arrow 1.
3. Fit the open-end wrench onto the hexagonal section of the release tool. Insert the release tool counter to the spring force until the stop is reached, press and rotate in the arrow direction 2 until it noticeably engages and meets a perceptible resistance.
4. Without releasing, continue to turn counter to the mechanical resistance of the drive unit in the arrow direction 2 until you can

feel a significant increase in the force of the resistance.

**⚠** To prevent possible damage to the rear brakes, always make sure that the parking brake is completely released before driving the vehicle. ◀

5. Return the tools to their places.
6. Return the spare tire cover and the floor mat to their original locations.

**⚠** Have a malfunction corrected only by a BMW center or a repair shop that works in accordance with BMW guidelines and uses appropriately trained personnel. Only technicians can return the parking brake to normal operational status after it has been released manually in response to a malfunction. ◀

**▶** Following manual release, the actual status of the parking brake may deviate from that displayed by the indicator lamp. ◀

## Reinitializing after a power supply interruption

**⚠** The parking brake can only be used again if it was manually released due to an interruption in the supply of electrical power. Otherwise, the function of the parking brake is not guaranteed and there is a danger of the vehicle rolling despite the parking brake being engaged. ◀

Once the electrical power supply has been restored, you can again use the parking brake:



With the ignition on and the vehicle stationary, briefly press the button three times at intervals of approx. 5 seconds. This executes the following initialization sequence:

- ▷ Initializing the disengaged setting.
- ▷ Engaging: the system registers the new status and the brake setting is initialized. The indicator lamp (P) on Info Display lights up green.
- ▷ Releasing: the parking brake is ready for operation. The indicator lamp (P) on the Info Display goes out.

## Automatic transmission with Steptronic

In addition to fully automatic operation, you can also shift manually using the buttons on the steering wheel, refer to page 63.

### Transmission range selection

P R N D

### Displays on Info Display



P R N D S or M1 to M6

The transmission range is indicated, and in the manual mode, the gear currently engaged.

### Selecting transmission range

- ▷ Only engage transmission positions D, R, or N when the engine is running: interlock.
- ▷ With the vehicle stationary, depress the brake pedal before shifting out of P or N; otherwise, the shift command will not be executed: shiftlock.

 To prevent the vehicle from creeping after you select a driving position, maintain pressure on the brake pedal until you are ready to start off. Activate Automatic Hold to suppress the tendency to creep, refer to page 59. ◀

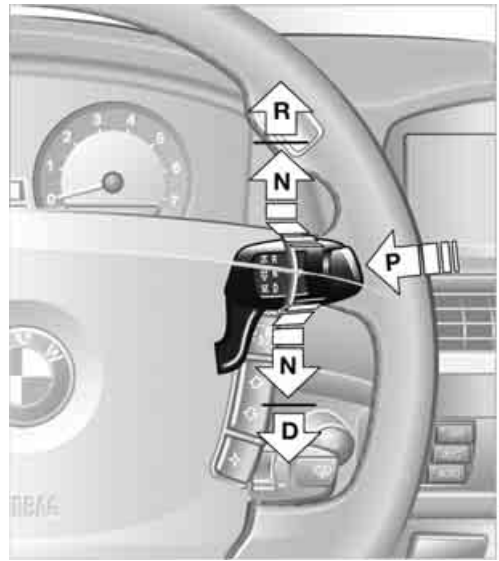

The engaged position is indicated on the Info Display.

### Selecting D, R or N

Lightly pull selector lever and engage desired position:

- ▷ N Neutral:  
To resistance point, arrows **N**.
- ▷ D Drive:  
Downward past resistance point, arrow **D**.
- ▷ R Reverse:  
Upward past resistance point, arrow **R**.

The selector lever immediately returns to the center position when released.

### Selecting P

Press button **P**.

### P Park

Select only when the vehicle is stationary. The rear wheels are locked.

 Transmission automatically shifts into P as soon as you switch off the engine unless N is selected and the remote control is in the ignition lock, refer to page 58. ◀



## R Reverse

Select only when the vehicle is stationary.

## N Neutral

You can select this position, for example, in car washes. The vehicle can roll.

 Transmission remains in N even after the ignition is switched off whenever you leave the remote control in the ignition lock. This function is useful in automatic car washes, etc.

After approx. 30 minutes the system automatically shifts into position P. Pay attention to the messages on the Info Display.

Switching off engine, refer to page 58. ◀

## D Drive, automatic position

This is the mode recommended for normal vehicle operation. All forward gears are available.

Under normal operating conditions, the fuel consumption is lowest when driving in position D.

## Kick-down

The kick-down mode provides you with maximum acceleration.

Press the accelerator pedal beyond the full-throttle resistance point.

## Sport program and manual operation



Press button **1** on the steering wheel.

The sport program is activated and S appears on the Info Display. This program is recommended for a performance-oriented driving style.

Press button **1** again to switch into the manual mode and then into the automatic program again.

In the manual mode, the Steptronic changes gears when one of the buttons **2** on the front or back of the steering wheel is briefly pressed. The Info Display shows the manual ranges M1 through M6.

Upshifts and downshifts are executed only when they will result in a plausible combination of engine and vehicle speed; thus, for example, the system will not execute a downshift that would cause the engine to overrev. In this case, the requested gear appears briefly on the Info Display, followed by the current gear.

Press button **1** again to switch back into the automatic program.

## Manually unlocking and locking the transmission lock

In the event of a power supply interruption, e.g. when the battery is dead or disconnected or when there is an electrical malfunction, the transmission lock must be released manually; otherwise, the rear wheels are locked and the vehicle cannot be towed.

**⚠** Step on the brake when manually unlocking the transmission lock; otherwise, there is a danger of the vehicle rolling. ◀

The transmission lock should only be released for towing. Reengage the transmission lock after parking the vehicle at its destination.

If it also becomes necessary to manually release the parking brake, follow this sequence:

1. Start by manually releasing the parking brake, refer to page 60.
2. Then proceed to manually releasing the transmission lock.

### Releasing

1. Use the vehicle key to release the cover panel beneath the instrument panel by turning the lock counterclockwise, then fold down the cover.



2. Pull out the release lever with the loop 1 until it locks into place: the transmission lock is unlocked.



- ⚠** Reengage the transmission lock after parking the vehicle at its destination. Otherwise, there is a danger of the vehicle rolling. ◀

### Engaging locks

1. Disengage the release lever by pressing it together with the red locking lever, refer to arrow.



2. Guide the release lever all the way back into its original position – the transmission lock is engaged once more.
3. Fold up and lock the cover panel again. Now – and not before – the key may be removed.

Jump starting and tow starting information, refer to section starting on page 220.

## Turn signals/ headlamp flasher



- 1 High beams
- 2 Headlamp flasher
- 3 Turn signals

### Using turn signals

Move the lever beyond the resistance point.

If you wish to manually control the shut-off of the turn signal, then only push the lever to the resistance point.

 Atypically rapid flashing of the indicator lamps signals the failure of a turn signal lamp, possibly in the trailer when towing. ◀

### Temporarily signaling

Push the lever to the resistance point and hold it there for as long as you wish to signal.

### Triple turn signal activation

Press the lever to the resistance point and release; the turn signal flashes three times.

## Wiper system

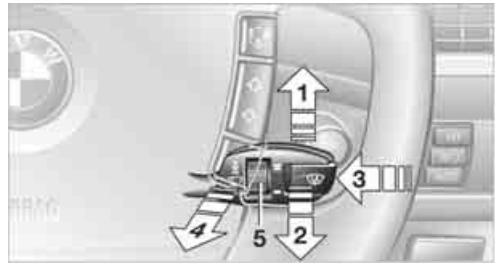

- 1 Switching on wipers
- 2 Switching off wipers or for brief wipe
- 3 Activating/deactivating rain sensor
- 4 Cleaning windshield, headlamps and BMW Night Vision camera\*
- 5 Adjusting rain sensor sensitivity level

### Switching on wipers

The lever automatically returns to its initial position when released.

### Normal wiper speed

Press once.

The system reverts to operation in the intermittent mode when the vehicle is stationary.

### Fast wiper speed

Press twice or press beyond the resistance point.

The system reverts to normal speed when the vehicle is stationary.

### Rain sensor

The rain sensor controls the wiper operation as a function of the rain intensity. It is located on the windshield, directly in front of the inside rearview mirror.

## Activating rain sensor

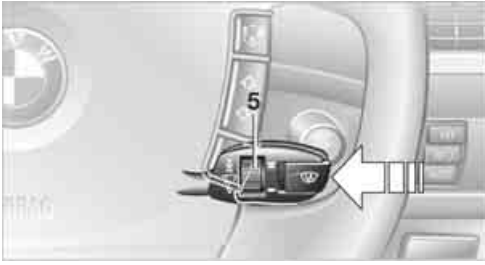

Briefly press the button, arrow, the wipers move once across the windshield. The LED lights up.

## Adjusting rain sensor sensitivity level

Turn the knurled wheel 5.

## Deactivating rain sensor

Briefly press the button again, arrow. The LED goes out.

 Deactivate the rain sensor when passing through an automatic car wash. Failure to do so could result in damage caused by undesired wiper activation. ◀

## Cleaning windshield, headlamps and BMW Night Vision camera\*

The system sprays washer fluid against the windshield and activates the wipers for a brief period.

With the vehicle lighting switched on, the headlamps and the BMW Night Vision camera are also cleaned simultaneously at suitable intervals.

 Do not use the washers if there is any danger that the fluid will freeze on the windshield. If you do so, your vision could be obscured. To avoid freezing, use a washer fluid antifreeze, refer to Washer fluid.

Avoid using the washer when the reservoir is empty. Otherwise, you could damage the pump. ◀

## Windshield washer nozzles

The windshield washer nozzles and the windshield itself in the area around the wipers are

heated automatically when the ignition is switched on.

## Pivoting wipers into folded-out position

This position is important for changing wiper blades or when folding wiper arms away from windshield to prevent blades from sticking in the event of frost.

1. Switch off the engine and remove the remote control from the ignition lock.
2. Press the wiper lever upward past the resistance point and maintain pressure for about 3 seconds until the wipers stop in a roughly vertical position: pivot into the folded-out position.

After folding the wipers back against the windshield you will need to reactivate the wiper system:

1. Switch on radio ready state.
2. Briefly press wiper lever downward. The wipers return to their retracted position and are ready for normal operation.

 To prevent damage to the wipers, always fold them back against the windshield before switching on either the radio ready state or the ignition. ◀

## Washer fluid

 Washer fluid antifreeze is flammable. Always keep it well away from sparks and open flames, and store it in tightly closed containers well out of the reach of children. Always follow the instructions for use provided on the containers. ◀

## Wiper fluid filler neck

 Only refill wiper fluid when the engine is cool in order to prevent contact with hot engine components. Otherwise, there is a risk of burns and personal injury if the fluid spills. ◀



All of the washer jets are supplied from a single tank.

Fill with water and – if required – with a washer antifreeze, according to manufacturer's recommendations.



In order to maintain the mixture ratio, mix the washer fluid before filling. ◀

## Capacity

Approx. 6.3 US quarts/6 liters.

# Programmable cruise control

## The concept

The programmable cruise control is available for use at speeds of approx. 20 mph/30 km/h and higher. The vehicle maintains and stores the speed that you set using the lever mounted on the steering column.

You can also use the multilevel preset mode to store six desired speeds for later selection with the lever, refer to page 67.

This feature assists you in quickly adapting the vehicle speed to specific road conditions, e.g. changes in speeds limits.



Do not use the programmable cruise control when unfavorable conditions do not permit you to drive at a constant speed, e.g. when driving on winding roads, in heavy traffic or under poor road conditions such as snow, rain, ice, or a loose road surface. If you do, you could lose control of the vehicle and cause an accident. ◀

## One lever for all functions

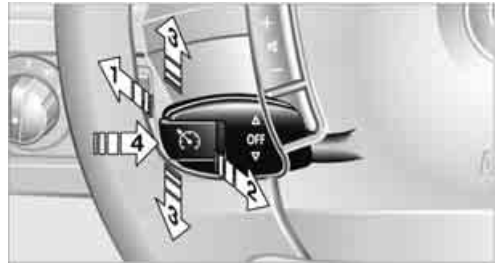

- 1 Maintaining speed, storing, and accelerating
- 2 Maintaining speed, storing, and decelerating
- 3 Interrupt or deactivate cruise control
- 4 Resuming stored speed

## Maintaining speed, storing, and accelerating

Press lever to resistance point, arrow 1:

The system maintains and stores the current vehicle speed. The pointer 5 in the speedometer indicates this speed, refer to Displays in speedometer on page 68. Each time the lever is pressed again briefly, the speed is increased by approx. 1 mph or 1 km/h.

Push the lever to the resistance point for a longer time:

The vehicle accelerates without pressure on the accelerator pedal. The system maintains and stores your current speed as soon as you release the lever.

Press the lever past the resistance point if no desired speeds 6 are stored:

The pointer 5 jumps to the next multiple of 5 mph or 10 km/h and then further, as long as the lever is held. The speed then indicated is reached and stored.

The vehicle may accelerate beyond the preset speed on steep downhill stretches where the engine's braking action alone may not be sufficient to slow the vehicle. Speed can drop on uphill grades if the engine output is insufficient.

## Maintaining speed, storing, and decelerating

Pull the lever, arrow **2**:

Functions in the same way as **1**, except that the vehicle speed is decreased.

## Interrupting the cruise control

Briefly press the lever up or down, arrow **3**.

In addition, cruise control is interrupted automatically:

- ▷ when you apply pressure to the brake pedal
- ▷ when you shift the automatic transmission into position N
- ▷ when the DSC control is operative

## Resuming stored speed



Briefly press the button **4**:

The vehicle accelerates back to and maintains the stored speed.

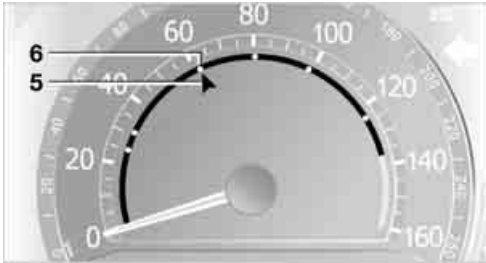
## Displays in speedometer



**5** Pointer for stored speed

- ▷  Cruise control activated
- ▷  Cruise control deactivated

**6** Mark for stored desired speed in the multi-level function

## Storing desired speeds

### With vehicle stationary

1. Switch on the ignition.
2. Press, arrow **1**, or pull, arrow **2**, the lever past the resistance point:  
Now you can move the pointer **5** with the

lever until you have reached your desired speed:

- ▷ Press or pull the lever to the resistance point again: the pointer slowly moves.
- ▷ Press or pull the lever past the resistance point again: the pointer jumps to the next multiple of 5 mph or 10 km/h and then further, as long as the lever is held.

3. Press the button **4** for approx. 3 seconds. The stored desired speed is indicated by a mark **6**.

If six desired speeds have already been stored, please delete at least one of them before adding another.

## While driving

1. Press, arrow **1**, or pull, arrow **2**, the lever past the resistance point.
2. Press the button **4** for approx. 3 seconds. The current speed is applied as the desired speed and displayed with **6**.

If all of the marks **6** flash twice, this indicates that six desired speeds have already been stored. You must then delete at least one of them before adding another.

## Deleting desired speeds

1. Select corresponding desired speed **6**, refer to section below.
2. Press button **4** for approx. 3 seconds.

## Activating multilevel preset mode

Press, arrow **1**, or pull, arrow **2**, the lever past the resistance point.

The current driving speed is maintained, stored and displayed by the pointer **5**.

## Selecting desired speed

Press, arrow **1**, or pull, arrow **2**, the lever past the resistance point:

The next desired speed is selected.

## Deactivating system

- ▷ Press the lever up or down, arrow **3** for approx. 3 seconds
- ▷ or switch off the ignition.

The stored speed **5** is deleted, however the stored marks **6** are retained.

## Active cruise control\*

### The concept

With active cruise control you can select a desired speed which is not only automatically maintained when driving on open roadways, but also varied to maintain a selected distance setting as slower traffic is encountered.

Active cruise control represents a technological advance over the familiar cruise control and is a welcome relief from the constant adjustment of speed that can accompany driving in traffic on highways or other high-speed thoroughfares. Especially on longer trips, the system can reduce fatigue and tension, while increasing your enjoyment of driving. Please use it safely and responsibly.

In addition to maintaining a steady cruising speed, if you encounter slower vehicles ahead, active cruise control will, within the scope of given possibilities, adjust your vehicle's speed automatically, permitting you to flow with the traffic without having to frequently intervene. If, for example, while cruising at the selected speed, you begin to approach a slower vehicle ahead of you in the same lane, the system will reduce your vehicle's speed to the same as that of the vehicle ahead to maintain your selected following distance between your vehicle and the vehicle ahead. You can vary the distance, which is additionally speed-dependent. Based on your selected distance setting, the system automatically decreases the throttle setting and lightly applies the brakes if necessary. The vehicle brake lamps will automatically illuminate to signal a following driver to take action. In addition, it may be necessary for the vehicle to downshift to maintain the distance setting selected. If the vehicle ahead speeds up or

when the lane ahead becomes clear, your vehicle will accelerate to the speed you have selected by increasing the throttle setting and shifting gears as needed. This setting is also maintained on steep stretches, but the vehicle speed can fall below this on uphill grades if the engine output is insufficient to maintain speed.



Active cruise control is not and must not be used as a collision avoidance/warning system. ◀



Since this active cruise control system is a new technology and operates differently from conventional cruise control systems to which you may be accustomed, you are strongly urged to read all of the pages relating to this system before use. Pay special attention to the information contained in the Things to know about active cruise control section beginning on page 72. ◀

### Brake pedal feel

- ▷ When the system brakes and you also depress the brake pedal, a somewhat different braking feeling results.
- ▷ Any noises produced during automatic braking are normal.

### Applications

As with conventional cruise control systems, active cruise control in no way diminishes or substitutes for the driver's own personal responsibility, alertness, and awareness in adjusting speed, braking, or otherwise controlling the vehicle. The driver should decide when to use the system on the basis of road, traffic, visibility, and weather conditions. Active cruise control is intended for use on highway-type roadways where traffic is moving relatively smoothly. Do not use this system in city driving; heavy traffic such as during rush hour; on curvy, winding roads, slippery roads or roads with sharp curves such as highway off-ramps; during inclement weather such as snow, strong rain or fog; or when entering interchanges, service/parking areas or toll booths. It is also important to regulate your vehicle's speed and distance setting within applicable legal limits. Adapt the

desired speed to traffic conditions, control both your driving speed and safe following distance, and remain ready to brake at all times. Always be ready to take action or apply the brakes if necessary, especially when the system is actively following a vehicle in front of you. Otherwise driving situations can arise that constitute an accident hazard.

The minimum desired speed is 20 mph or 30 km/h, the maximum is 110 mph or 180 km/h.

## One lever for all functions



- 1 Store and increase desired speed
- 2 Store and decrease desired speed
- 3 Deactivate system, refer to page 71
- 4 Resume stored desired speed and distance, refer to page 71
- 5 Select distance to vehicle driving ahead, refer to page 70

## Storing current speed

Briefly press, arrow 1, or briefly pull, arrow 2, lever.



The current driving speed is stored and briefly displayed on the speedometer, refer to arrow.

## Increasing desired speed

Press or tap the lever to the resistance point or beyond, arrow 1, until the desired speed is displayed.

The speed then displayed is stored and reached on clear roads.

- ▷ Each time the lever is briefly pressed to the resistance point, the desired speed increases by approx. 1 mph or 1 km/h.
- ▷ Each time the lever is briefly pressed past the resistance point, the desired speed increases to the next multiple of 5 mph or 10 km/h.

## Decreasing desired speed

Pull the lever, arrow 2, until the desired speed is displayed.

These functions are operated in the same manner as increasing your desired speed.

## Selecting distance

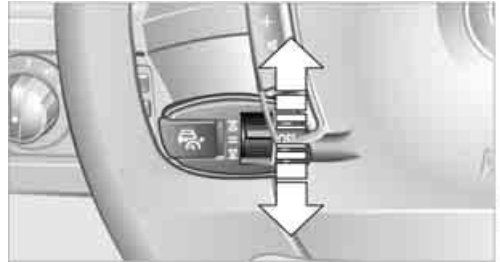

- ▷ Up:  
To increase distance
- ▷ Down:  
To decrease distance

The selected distance is displayed in the speedometer.





Distance 1



Distance 2



Distance 3

This distance is always set when the system is used for the first time after starting the engine.



Distance 4

**!** Use good judgment to select the appropriate following distance given road conditions, traffic, applicable laws and driving recommendations for safe following distance; failure to do so can constitute an accident hazard. ◀

## Deactivating cruise control



Press the lever up or down. The displays in the speedometer go out.

In addition, the system is automatically deactivated:

- ▷ when the speed is reduced to below 20 mph or 30 km/h due to a traffic situation
- ▷ when DTC is activated or DSC is deactivated
- ▷ when the system does not recognize any objects for an extended period of time, e.g.

on infrequently traveled roads without a shoulder or guard rails, or if the radar sensor is covered with dirt, refer to page 72

- ▷ when you actuate the parking brake during driving
- ▷ when you shift the transmission into position N

**!** If the system is deactivated, then it is necessary for the driver to actively intervene by braking and possibly swerving. Otherwise, there is the danger of an accident. ◀

## Background lighting

You can switch off the backlighting of the speedometer and tachometer when the system is deactivated if no other functions are being displayed, e.g. the advance warning field in the tachometer, refer to page 75, or the route guidance of the navigation system.

To do so, press the lever up or down for approx. 1 second.

## Resuming stored desired speed and distance

Press button 4:

The displays appear in the speedometer.

When you switch off the ignition, the stored desired speed is deleted.

## Info Display screen contents



- 1 Stored desired speed display
- 2 Lights up: vehicle detected ahead
- 3 Selected distance to vehicle driving ahead
- 4 The selected desired speed is displayed for a short time, refer to page 70

 If the display ACC --- mph/ACC --- km/h appears briefly in the speedometer, then conditions required for operation may not currently be fulfilled. Retrieving Check Control messages, refer to page 81. ◀

### Warning lamps



The display flashes and a chime sounds. The system asks you to intervene by braking or with an evasive maneuver. The active cruise control cannot automatically restore the distance to the vehicle driving ahead.

The display does not relieve you of the responsibility for adapting desired speed and driving style to traffic conditions.



Automatic intervention by ABS or DSC. The active cruise control intervenes by braking until you actively intervene.

### Radar sensor



Heavy rain and also dirt, snow, or ice can limit the detection of vehicles ahead. If needed, clean the radar sensor under the front bumper. When doing so, be particularly careful in removing layers of snow and ice.

If the sensor is not aligned properly, the active cruise control cannot be activated.

### Things to know about active cruise control

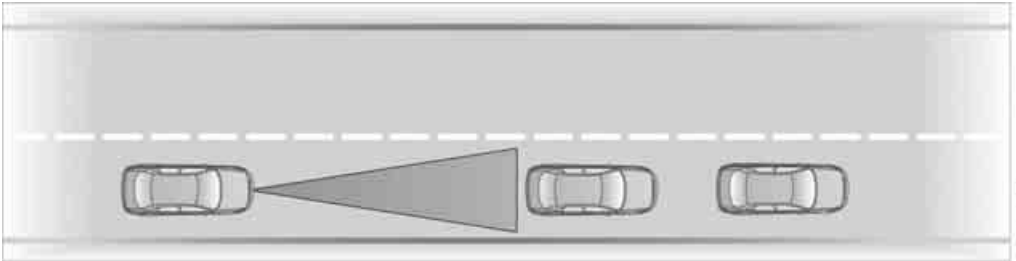

 As with conventional cruise control systems, active cruise control in no way diminishes or substitutes for the driver's own personal responsibility, alertness, and awareness in adjusting speed, braking, or otherwise controlling the vehicle. The driver should decide when to use the system on the basis of road, traffic, visibility, and weather conditions. Active cruise control is intended for use on highway-type roadways where traffic is moving relatively smoothly. Do not use this system in city driving; heavy traffic such as during rush hour; on curvy, winding roads, slippery roads or roads with sharp curves such as highway off-

ramps; during inclement weather such as snow, strong rain or fog; or when entering interchanges, service/parking areas or toll booths. It is also important to regulate your vehicle's speed and distance setting within applicable legal limits. Always be ready to take action or apply the brakes if necessary, especially when the system is actively following a vehicle in front of you. ◀

 Always remember that the range and ability of the system do have physical limitations. It will not apply the brakes or decelerate your vehicle when there is a slow-moving vehicle, stopped vehicle or stationary object ahead

of you, for example when approaching a traffic light or a parked vehicle. Also, the system does not react to oncoming traffic, pedestrians or other types of potential traffic such as a rider on horseback. It is also possible that the system may not detect smaller moving objects such as motorcycles or bicycles. Be especially alert when encountering any of these situations as the system will neither automatically brake, nor provide a warning to you. Also, be aware that every decrease in the distance setting allows your vehicle to come closer to a vehicle in front of you and requires a heightened amount of alertness. ◀

When your vehicle is actively following a vehicle in front of you, if the vehicle ahead speeds up or the lane ahead becomes clear, then your vehicle will accelerate to the speed you have selected. Be aware that changing to a clear, unobstructed lane may also result in acceleration of your vehicle.

**⚠** Be certain to deactivate the system when you pull into an exit lane for a highway off-ramp. ◀

Also, vehicles traveling in a staggered manner on a highway may cause a delay in the system's reaction to a vehicle in front of you or may cause the system to react to a vehicle actually in the lane next to you. Always be ready to take action or apply the brakes if necessary.

Active cruise control can only decelerate the vehicle to approx. 20 mph/30 km/h. If the system reduces vehicle speed below 20 mph/30 km/h or if DSC/ABS is engaged while driving, the system will automatically deactivate.

**⚠** Remember, the system cannot stop your vehicle. In addition, the system is deactivated whenever the driver applies the vehicle brakes, shifts the transmission from drive/D to neutral/N, or deactivates DSC. After any deactivation, the system will no longer automatically activate the vehicle brakes, which means the driver must intervene and resume manual braking. You should then reactivate the system only when you are fully aware of the prior speed and distance settings. ◀

Active cruise control may brake when you reduce the stored desired speed; however, the driver must constantly monitor traffic and intervene if necessary.

When you switch off the engine or ignition, active cruise control is fully switched off, too, and any settings you have selected are canceled.

## Swerving vehicles

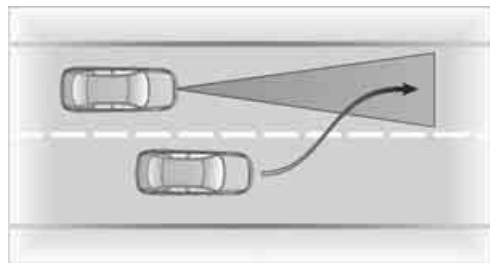

When a vehicle moves from an adjacent lane into your lane, active cruise control will not detect this vehicle until it is fully in your lane ahead of your vehicle.

## Behavior in curves





Because of the limited range of the system, it is possible that in curves or on the peaks and valleys of hilly roads, a vehicle ahead may be recognized late, or not at all. Therefore, it is up to the driver to select a speed that is prudent in view of the curves and terrain of the roadway.



In approaching a curve, it is possible that active cruise control might react briefly to a vehicle in the adjacent lane. In addition, the system can sense if your vehicle is in a curve and may not accelerate. If your vehicle decelerates in either case, you can choose to overcome the deceleration by briefly pressing the accelerator pedal.

### Driver interventions

 Anytime the driver presses down on the accelerator pedal, any automatic braking action by the system is interrupted until the pedal is fully released. After doing this, release the accelerator and the system again controls your cruising speed and distance setting. While driving with the system activated, resting your foot on the accelerator pedal will cause the system not to brake even if necessary. Be certain that floor mats or other objects on the vehicle floor do not interfere with movement of the accelerator pedal. ◀

 While active cruise control is capable of braking your vehicle automatically when you approach a slower vehicle ahead, it is important to be aware that the ability of the system to apply the brakes is also limited, e.g. when you reduce your desired speed sharply. The system cannot stop your vehicle. It uses only a portion of braking system capacity and does not utilize the full capacity of the vehicle braking system. Therefore, the system cannot decrease your speed for large differences in speed between your vehicle and the vehicle ahead. Examples: when you approach a vehicle traveling at a much lower speed than your own speed such as approaching a toll booth or when a much slower vehicle cuts in front of you at close range. ◀

# Everything under control

## Odometer, outside temperature display, clock



- 1 Outside temperature display, clock
- 2 Odometer
- 3 Trip odometer
- 4 Press button:
  - ▶ with ignition switched on to reset trip odometer
  - ▶ with ignition switched off to briefly display odometer, outside temperature, and time

### Outside temperature display, clock, date

The outside temperature and the time displays are active with the ignition lock in radio ready state or higher.

You can change the units of measure, °F/°C, in the "Settings" menu, refer to page 84.

Setting the clock, refer to page 84.

The date is displayed in the assistance window\*, refer to page 21.

Setting date, refer to page 84.

### Outside temperature warning

If the display drops to +37 °F / +3 °C, a signal sounds and a message appears on the Info Display. There is an increased danger of ice.

 Even at temperatures above +37 °F / +3 °C, ice can form. Therefore, drive carefully, e.g. on bridges and shaded roadways; otherwise, there is an increased accident risk. ◀

### Odometer and trip odometer

The display area is also used for the computer and the Check Control.

Regardless of the current display, you can briefly display the odometer for a short time by briefly pressing button 4. Pressing the button again resets the trip odometer to zero.

Check Control, refer to page 80.

Computer, refer to page 76.

### Tachometer



The orange advance warning field, arrow, is displayed as a function of the engine temperature. The segments disappear in sequence as the engine temperature increases.

Avoid allowing the engine speed to rise as far as the orange advance warning field whenever possible.

## Coolant temperature

Should the coolant, and with it the engine become too hot, a warning lamp lights up. In addition, a message appears on the Control Display.

Checking coolant level, refer to page 210.

## Computer

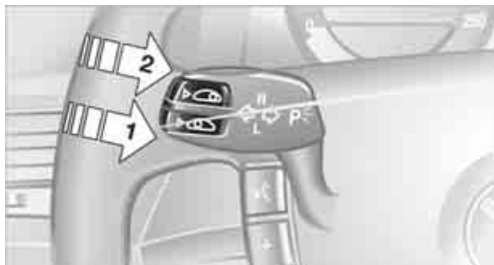

### Requesting functions

You can use the buttons in the turn signal lever to display the computer information on the Info Display.

- 1 Info Display on left
- 2 Info Display on right

A new function appears each time you briefly press the button.

### Displays on Info Display



The display sequence:

- ▷ Fuel gauge
- ▷ Range and distance to destination



The display sequence:

- ▷ Odometer
- ▷ Energy Control/current fuel consumption
- ▷ Average fuel consumption
- ▷ Average speed
- ▷ Time of arrival

### Hiding messages

Maintain pressure on button 1 to hide the computer display. Briefly press the button again to return to the last display.

- ▷ It is not possible, though, to hide a Check Control message. ◀

### Fuel gauge

The fuel gauge mode appears automatically once the fuel level falls into the reserve range. The tanks still contains the following quantities of fuel:

- ▷ 750i/Li: approx. 2.6 US gal/10 liters.
- ▷ 760i/Li: approx. 3.1 US gal/12 liters.

If the tilt of the vehicle varies, when you are driving in mountainous areas, for example, the indicator may fluctuate slightly.

- ▷ After reaching the reserve quantity, the Info Display can no longer be hidden.

However, you can still display the remaining range. ◀

Fuel tank capacity: approx. 23.2 US gal/ 88 liters. You can find information on refueling on page 198.

- ▷ Refuel well before the tank is empty. If you drive down to the last drop, engine functions are not assured and damage can occur. ◀

## Cruising range

Displays the estimated cruising range available with the remaining fuel. It is projected by taking into account the driving style over the last 20 miles/30 km.

 When your cruising range falls below 30 miles/50 km, be sure to refuel. Otherwise, engine functions are not assured and damage can occur. ◀

The computer only registers refueling amounts greater than approx. 1.3 US gal/5 liters.

## Distance to destination

When you enter a destination into the navigation system, refer to page 131, or manually enter a distance in the computer, refer to page 78, prior to departure, then the system displays the remaining distance to your destination.

The system automatically adopts the distance to your destination on the route recommended by the navigation system.

 When you enter a destination into the navigation system, any manual distance entries will be overwritten once the vehicle has traveled approx. 1,640 ft/500 m of the calculated distance. ◀

## Energy Control/current fuel consumption

Shows the current fuel consumption. This allows you to see whether your current driving style is conducive to fuel economy with minimum exhaust emissions.

## Average fuel consumption

The average fuel consumption is determined for the time during which the engine is running.

## Average speed

Periods with the vehicle parked and the engine off are not included in the calculations of average speed.

You can reset value for average fuel consumption and average speed, refer to Resetting values, page 78.

## For different route segments

You can display the average speed and average fuel consumption for two different route segments:

- ▷ refer to Displays on Control Display below
- ▷ refer to Trip computer on page 78

## Time of arrival

A display of your estimated time of arrival is available whenever you enter a destination into the navigation system, refer to page 131, or enter the distance manually into the computer, refer to page 78, prior to departure.

 A prerequisite for this is that you have the time set correctly, refer to page 84. ◀

## Displays on Control Display

You can also access the computer via iDrive, for principle details, refer to page 16.

1. Press the **MENU** button to open the start menu.
2. Move the controller toward "Car Data".
3. Select "BC" and press the controller.



- ▷ Anticipated arrival time at destination and remaining distance:
  - ▷ To enter a distance into the computer manually, refer to Entering a distance manually
  - ▷ To enter a destination into the navigation system, refer to page 131
- ▷ Cruising range
- ▷ Average fuel consumption
- ▷ Average speed

### Resetting values

You can reset values for the average speed and average fuel consumption:

1. Activate the relevant menu item and press the controller.
2. Press the controller again to confirm your selection.

This also resets the information currently shown on the Info Display.

### Entering a distance manually

1. Select "To dest." and press the controller.



2. Turn the controller to set the distance to the destination.
3. Press the controller to save the setting.

The distance to the destination is automatically predetermined when using the navigation system route guidance, refer to page 144.

### Using voice command system

›On-board computer‹.

### Trip computer

The trip computer can be used, e.g. for a vacation trip.

iDrive, for principle details, refer to page 16.

1. Press the **MENU** button to open the start menu.
2. Move the controller toward "Car Data".

3. Select "BC  and press the controller.



- ▷ Departure time
- ▷ Driving time
- ▷ Distance traveled
- ▷ Average fuel consumption
- ▷ Average speed

To switch trip computer on/off and reset all values:

Select "START / RESET" and press the controller.

To deactivate trip computer:

Select "STOP" and press the controller.

### Service required



The distance or time period remaining until your next service briefly appears when you switch on the ignition.

 Your Service Advisor will determine your vehicle's current service requirements by reading out the data stored in the remote control. ◀

With BMW Assist enabled, information about maintenance status of your vehicle or information about legally mandated inspections is automatically transmitted before the relevant



deadline, refer to Automatic service notification on page 190.

## Additional information

You can view additional information on service and maintenance procedures on the Control Display.



iDrive, for principle details, refer to page 16.

1. Press the **MENU** button to open the start menu.
2. Move the controller toward "Car Data".
3. Select  and press the controller.



The display shows a list of selected service and maintenance procedures, as well as legally-mandated inspections.

## Symbols

-  No service is currently required.
-  The deadline for service or a legally-mandated inspection is approaching. Please arrange for a service appointment at the earliest available opportunity.
-  The service deadline has already passed.

You can view more detailed information about every entry:

Select the entry and press the controller.

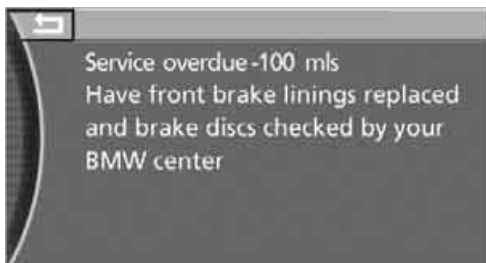

To exit the menu:

 The arrow is selected. Press the controller.

 Condition Based Service does not continue counting down to the next service during periods when the vehicle is stored with the battery disconnected or the battery switch in the OFF position.

It is therefore important, independent of the display, to change the brake fluid at least every 2 years.

The same is true for other time-dependent maintenance procedures. ◀

## Deadlines for scheduled legally mandated inspections, displaying and entering

Make sure the date and time are always set correctly, refer to page 84; otherwise, CBS Condition Based Service cannot function correctly.

iDrive, for principle details, refer to page 16.

1. Press the **MENU** button to open the start menu.
2. Move the controller toward "Car Data".
3. Select  and press the controller.
4. Select "State inspection" and press the controller.

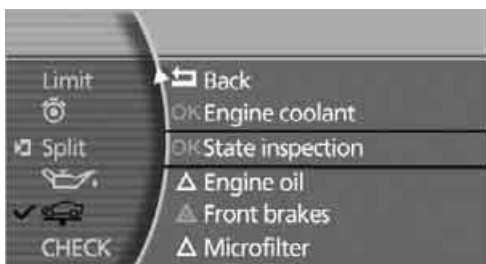

5. Turn the controller to select appointment input.
6. Press the controller. The month is selected.
7. Turn the controller to adjust the setting.



8. Press the controller to save the setting. The year is selected.
9. Turn the controller to adjust the setting.
10. Press the controller to save the setting.
11. "STORE DATE" is selected. Press the controller to save the setting. The date entry is saved.

The list of entries is resorted by date.

### Display on Info Display



If the deadline for your next state vehicle inspection is approaching, the remaining distance and time will appear briefly when you switch on the ignition.

- ▶ Your Service Advisor will determine your vehicle's current service requirements by reading out the data stored in the remote control. ◀

## Check Control

### The concept

Check Control monitors functions in the vehicle and generates a message if a malfunction occurs in the monitored systems. A Check Control message of this kind includes indicator or warning lamps on the Info Display and possibly an acoustic signal and text messages on the Info Display.

### Indicator and warning lamps



Control and warning lamps can light up in various combinations and colors.

### Explanatory text messages



Text messages on the Info Display explain the meaning of the indicator and warning lamps shown.

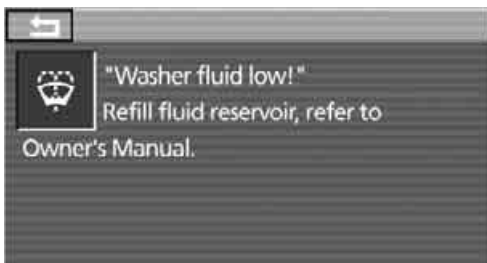

You can view additional information about most Check Control messages, e.g. regarding the cause of a malfunction and action required, refer to Viewing additional information on page 81.

In urgent cases, this information will be shown as soon as the corresponding lamp comes on.

An acoustic signal sounds at the same time.

To exit the menu:

 The arrow is selected. Press the controller.

## Hiding Check Control messages



Press the button on the turn signal lever.

Some Check Control messages are displayed until the related malfunction is rectified: they cannot be hidden. If several malfunctions occur simultaneously, then the Check Control messages are displayed in sequence.

Other Check Control messages are hidden after roughly 20 seconds, but remain stored in memory.

## Viewing stored Check Control messages

### Using CHECK button

1. Press the button longer:  
The first stored message is displayed.



2. Briefly press the button:  
A new message appears each time you press the button.



### Viewing additional information

iDrive, for principle details, refer to page 16.

1. Press the **MENU** button to open the start menu.
2. Move the controller toward "Car Data".
3. Select "CHECK" and press the controller.

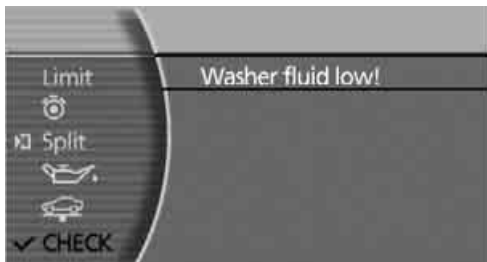

The stored status reports appear on the display.

4. Select a message and press the controller.

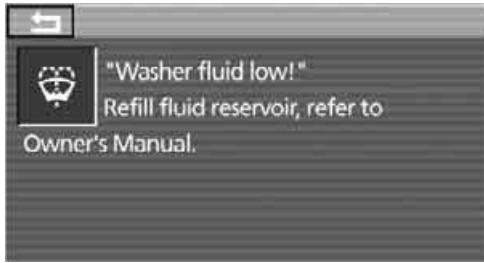

To exit the menu:

1. The arrow is selected. Press the controller.

### Display of malfunction urgency

Depending on the status of the monitored systems, the symbol in the status line is displayed in different colors.

### Yellow or red

Malfunctions are present in the monitored systems. Depending upon how serious the problem is, a supplementary message may also appear on the Control Display.

The symbol also indicates the status of the service requirements, refer to Symbols on page 79.

### Displays after trip completion

Selected malfunction reports generated during the trip are shown again consecutively when you switch off the ignition.

Even with the ignition and display off, you can display the messages on the Info Display:

Press the CHECK button for approx. 8 seconds, refer to page 81. The stored status reports appear again in the display. If several messages are present, you can continue to briefly press the CHECK button to view them in succession. The Check Control function is terminated:

- ▶ automatically after a brief period
- ▶ if you press the CHECK button again for approx. 8 seconds.

## Speed limit

You can enter a speed and a Check Control message will indicate when you have reached this speed. This enables you, for example, to receive warnings if you exceed a speed limit in an urban area.

You are only warned of reaching this speed a second time if your speed has dropped to at least 3 mph/5 km/h slower than this speed limit since the last warning.

### Displaying, adjusting, or changing limit

iDrive, for principle details, refer to page 16.

1. Press the **MENU** button to open the start menu.
2. Move the controller toward "Car Data".
3. Select "Limit" and press the controller.
4. Select "SET" and press the controller.



5. Turn the controller to adjust the limit.
6. Press the controller to save the setting.

### Applying your current speed as limit

Select and press the controller.

The system applies your current speed as the limit.

### Activating/deactivating limit

Select "ON / OFF" and press the controller. When the speed limit is switched on, "ON / OFF" is highlighted.

## Limit on Info Display

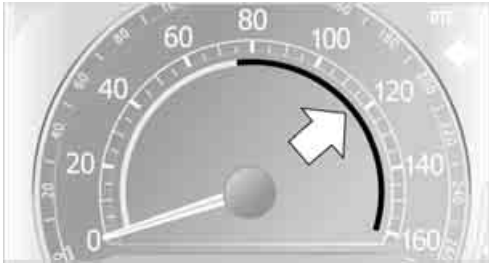



If, for instance, the advance warning field in the tachometer is activated, refer to page 75, then the speed limit will be indicated by a warning field in the speedometer, refer to arrow.

## Stopwatch

### Starting and stopping

iDrive, for principle details, refer to page 16.

1. Press the **MENU** button to open the start menu.
2. Move the controller toward "Car Data".
3. Select  and press the controller.
4. Select  and press the controller. The stopwatch is reset to 0 and starts.



5. Select  and press the controller. This stops the timer. Press the controller again to reset the stopwatch to zero.

 All of the remaining functions remain available at all times while the stopwatch is running. The stopwatch continues to run in the background. ◀

## Taking an intermediate time reading

Select "INTERM. TIME" and press the controller. This intermediate time appears below the ongoing primary stopwatch count.

## Assistance window for onboard data

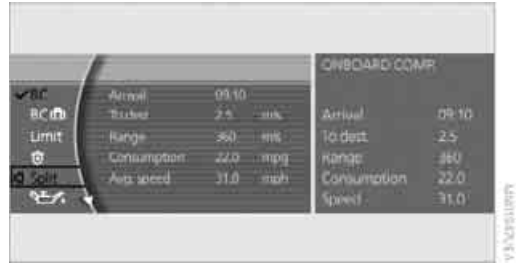

You can select any of the following computer functions for display in the assistance window:

- ▷ Computer
- ▷ Trip computer
- ▷ Speed limit
- ▷ Stopwatch

### Adopting display

iDrive, for principle details, refer to page 16.

1. Press the **MENU** button to open the start menu.
2. Move the controller toward "Car Data".
3. Select "BC" and press the controller.
4. Select  "Split" and press the controller. The function appears in the assistance window.

You can also choose to view brief help texts explaining selected menu items, refer to page 21, or the travel route with a navigation system, refer to page 130.

## Settings on Control Display

### Setting units of measure and display format

You can change the units of measure used in the displays of fuel consumption, distances and temperatures as well as the display format for the time and date.

iDrive, for principle details, refer to page 16.

1. Press the **MENU** button to open the start menu.
2. Move the controller toward "Settings".
3. Select "Units" and press the controller.



4. Select the menu item that you wish to adjust. Press repeatedly to view a listing of your selection options.

The setting is stored for the remote control currently in use.

### Setting language

You can select a different language for the text displays.

iDrive, for principle details, refer to page 16.

1. Press the **MENU** button to open the start menu.
2. Move the controller toward "Settings".

3. Select "Language" and press the controller.

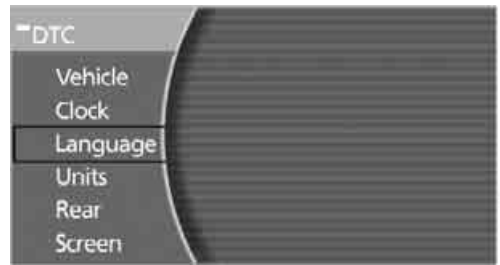

4. Select and activate the desired language.

The setting is stored for the remote control currently in use.

### Time and date

iDrive, for principle details, refer to page 16.

1. Press the **MENU** button to open the start menu.
2. Move the controller toward "Settings".
3. Select "Clock" and press the controller.

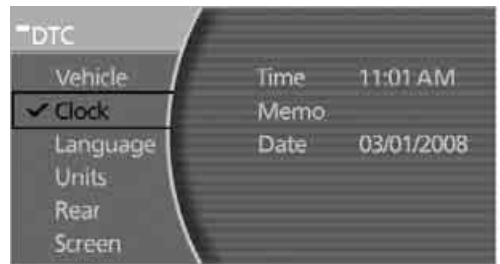

### Setting time

1. Select "Time" and press the controller. The first time setting is activated.
2. Turn to adjust the setting.
3. Press the controller to adopt the setting. The next setting is selected.
4. Adjust the remaining settings. After the last adjustment, the time is stored.

### Setting date

1. Select "Date" and press the controller. The first date display setting is activated.
2. Turn to adjust the setting.

3. Press the controller to adopt the setting. The next setting is selected.
4. Adjust the remaining settings. After the last adjustment, the date is stored.

The setting is stored for the remote control currently in use.

### Hour signal activation

You will hear four tones just before the top of each hour.

Select "Memo" and press the controller.

The ✓ symbol indicates the menu that is currently activated.

### Setting brightness

You can set the brightness of the screen.

iDrive, for principle details, refer to page 16.

1. Press the **MENU** button to open the start menu.
2. Move the controller toward "Settings".
3. Select "Screen" and press the controller.
4. Select "Brightness" and press the controller.



5. Turn the controller until you reach the desired setting and press the controller to accept the setting.

 Under unfavorable conditions, e.g. in bright surroundings, the brightness control of the screen might not be immediately recognizable. ◀

The setting is stored for the remote control currently in use.

# Technology for comfort, convenience and safety

## PDC Park Distance Control\*

### The concept

The PDC assists you when you are parking. Audible signals and an optical display indicate that you are approaching an object in front of or behind your vehicle. To measure the distance, four ultrasonic sensors are provided in each bumper. The range of these sensors is approx. 6 ft/2 m. However, an acoustic warning begins to sound for the sensors at the front and at the two rear corners at approx. 24 in/60 cm, and for the center rear sensors at approx. 5 ft/1.50 m.

 PDC is a parking aid that can indicate objects when they are approached slowly, as is usually the case when parking. Avoid approaching an object at high speed; otherwise, the system may sound the warning of physical obstacles too late. ◀

### Automatically activating

The system is activated approx. 1 second after you engage the transmission position R with the engine running or the ignition switched on. Wait this short period before proceeding.

### Manual activation



Press the button, the LED lights up.

### Manual deactivation

Press the button again; the LED goes out.

After driving approx. 165 ft/50 m or at over approx. 20 mph/30 km/h, the system switches off and the LED goes out. You can reactivate the system manually as needed.

### Signal tones

An intermittent signal indicates the distance of the vehicle from an object being approached. Thus, an object detected to the left rear of the vehicle will be indicated by a signal tone from the left rear speaker, etc. As the distance between vehicle and object decreases, the intervals between the tones become shorter. The signal tone becomes continuous once the distance to the nearest object falls below roughly 1 ft/30 cm.

An intermittent tone is interrupted after approx. 3 seconds:

- ▷ if you remain in front of an object that was only detected by one of the corner sensors
- ▷ if you drive parallel to a wall

### Malfunction

The LED in the button flashes and a message appears on the Info Display. PDC has failed. Have the system checked.

To prevent this problem, keep the sensors clean and free of ice or snow in order to ensure that they will continue to operate effectively. When using high-pressure washers, do not spray sensors for long periods and keep the sprayer at least 4 in/10 cm away from the sensors.

### PDC with visual warning

You can also have the system show distances to objects on the Control Display. Objects that are farther away are displayed there before a signal tone begins to sound.

iDrive, for principle details, refer to page 16.



1. Press the **MENU** button to open the start menu.
2. Move the controller toward "Settings".
3. Select "Vehicle" and press the controller.
4. Select "PDC pic." and press the controller. This activates the PDC display.

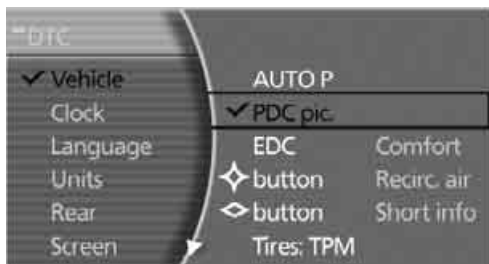

The display appears as soon as PDC is activated.

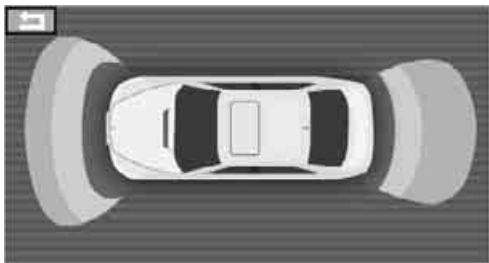

The setting is stored for the remote control currently in use.

To exit the menu:

Select the  arrow and press the controller.

## System limits

 Even with PDC, final responsibility for estimating the distance between the vehicle and any objects always remains with the driver. Even when sensors are involved, there is a blind spot in which objects cannot be detected. The system's detection of objects is also subject to the physical limits that apply to all forms of ultrasonic measurement, such as those encountered with tow bars and trailer couplings, as well as thin or wedge-shaped objects. Low objects already indicated, such as curb edges, may enter the blind spot of the sensors before or after a continuous audible signal

is given. Higher, protruding objects, such as wall ledges, may not be detectable. Loud noises from outside and inside the vehicle may also prevent you from hearing the PDC's signal tone. ◀

## Driving stability control systems

Your BMW is equipped with an extended array of systems designed to enhance and maintain vehicle stability under extreme conditions.

### ABS Antilock Brake System

ABS prevents the wheels from locking during braking. Safe steering response is maintained even during hard braking. This increases active driving safety.

ABS is operational every time you start the engine. For information on safe braking, refer to page 123.

### CBC Cornering Brake Control

This system provides further enhancements to vehicle stability and steering response when braking while cornering or when braking during a lane change.

### Electronic brake-force distribution

The system controls the brake pressure in the rear wheels to ensure a stable braking behavior.

### Brake assistant

When you apply the brakes rapidly, this system automatically produces the maximum braking force boost and thus helps to achieve the shortest possible braking distance during full braking. This system exploits all of the benefits provided by ABS.

Do not reduce the pressure on the brake pedal for the duration of the full braking.

### DSC Dynamic Stability Control

DSC prevents traction loss in the driving wheels when starting off and accelerating. The system also detects unstable driving conditions such

as fishtailing or sliding of the vehicle's front wheels. In these cases, DSC helps the vehicle safely stay on course within the physical limits by reducing the engine output and by applying the brakes in the individual wheels.

 The laws of physics cannot be repealed, even with DSC. An appropriate driving style always remains the responsibility of the driver. Do not squander your added margin of safety by driving dangerously; otherwise you run the risk of causing an accident. ◀

### Deactivating DSC

1. Press the **MENU** button to open the start menu.
2. Move the controller toward "Settings".
3. Select "DTC" and press the controller for at least 3 seconds.

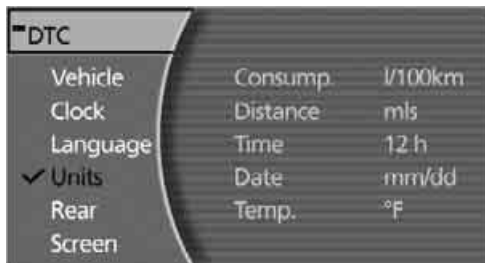

The LED for "DTC" and the DSC indicator lamp on the Info Display light up. DTC Dynamic Traction Control and DSC Dynamic Stability Control are deactivated together. Interventions promoting stability and forward momentum will no longer be carried out.

To promote enhanced operating stability, reactivate DSC again as soon as possible.

### Activating DSC

Select "DTC" and press the controller. The LED on the Control Display and the DSC indicator lamp on the Info Display go out.

#### For control purposes

 The indicator lamp flashes: DSC is controlling the drive forces and brake forces.

The indicator lamp comes on: DSC is deactivated.

### DTC Dynamic Traction Control

DTC is a version of DSC that is optimized for forward momentum in special road conditions. The system ensures maximum forward momentum, but with limited driving stability. Therefore, drive with appropriate caution.

You may find it useful to briefly activate DTC under the following special circumstances:

- ▷ When driving on snow-covered uphill grades, in slushy snow or on uncleared, snow-covered roads
- ▷ When rocking a stuck vehicle free or when starting off in deep snow or on loose ground
- ▷ When driving with snow chains

### Activating DTC

iDrive, for principle details, refer to page 16.

1. Press the **MENU** button to open the start menu.
2. Move the controller toward "Settings".
3. Select "DTC" and press the controller.

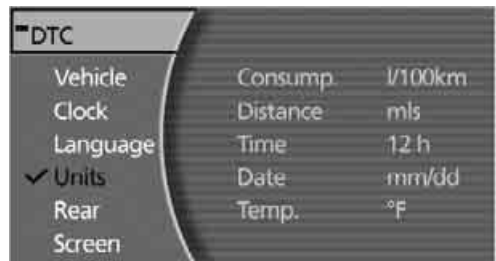

The LED for "DTC" and the DTC indicator lamp on the Info Display light up.

#### For control purposes

 The indicator lamp flashes: DTC is controlling the drive forces and brake forces.

 The indicator lamp comes on: DTC is activated.

## Deactivating DTC

Select "DTC" and press the controller. The LED on the Control Display and the DTC indicator lamp on the Info Display go out.

## Dynamic Drive

### The concept

Dynamic Drive minimizes body roll and optimizes vehicle stability during cornering and evasive maneuvers.

Active stabilizers at the front and rear axles form the basis for Dynamic Drive. Suspension compliance adapts to suit driving conditions, varying from performance-oriented during cornering to smooth and comfort-oriented when the vehicle is traveling in a straight line. During vehicle operation, the system continuously runs through closed-loop control cycles lasting only fractions of a second.

The system assumes operational status each time you start the engine.

### Malfunction



The warning lamp lights up yellow and a message appears on the Info Display. A malfunction has occurred in the Dynamic Drive system. Have the system checked as soon as possible.

**⚠** If a malfunction occurs, please remember to adapt your speed accordingly, especially in curves.

The suspension will be noticeably softer and the vehicle will display a greater tendency to tilt during cornering and in crosswinds. ◀

If a Check Control message indicates an oil loss, stop as soon as possible at a suitable location and switch off the engine. Do not continue driving, contact your BMW center.

## Self-leveling suspension\*

### Malfunction



The warning lamp for self-leveling suspension lights up yellow and a message appears on the Info Display.

A malfunction has occurred in the level control system.

Stop driving and check the vehicle:

- ▷ The vehicle is considerably lower at the rear than at the front, possibly also on one side, at the rear left compared to the rear right.
- ▷ The ground clearance is reduced or the driving comfort is noticeably reduced.
- ▷ The position of the vehicle is normal, but a malfunction is indicated.

Drive to the nearest BMW center or a workshop that works in accordance with BMW guidelines and uses appropriately trained personnel. Drive with appropriate caution in the meantime.

## EDC Electronic Damping Control\*

If the influencing variables such as road surface quality or operating conditions such as steering, braking etc. change, the damping automatically adjusts to the new conditions.

iDrive, for principle details, refer to page 16.

1. Press the **MENU** button to open the start menu.
2. Move the controller toward "Settings".
3. Select "Vehicle" and press the controller.
4. Select "EDC" and press the controller.

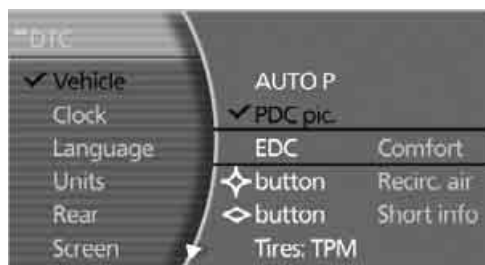

There are two programs. With each press of the controller, you can switch back and forth between "Comfort" and "Sport".

### Comfort program

The Comfort program is suitable for use throughout the vehicle's entire speed range and regardless of load.

### Sport program

You should select the Sport program for consistently performance-oriented response from shock absorbers and steering.

## FTM Flat Tire Monitor\*

### The concept

The Flat Tire Monitor keeps track of the inflation pressures in the four mounted tires as you drive. The system triggers an alert whenever the inflation pressure drops significantly in relation to the pressure in another tire.

When a loss of pressure occurs, the rolling radius changes and with it, the rotational speed of the wheels. This change is detected and signaled as a flat tire.

### Functional requirements

To ensure the reliable signaling of a flat tire, the system must be initialized at the correct tire inflation pressure.

▶ The initialization must be repeated after every correction of the tire inflation pressure and after every tire or wheel change. ◀

### System limits

⚠ The Flat Tire Monitor cannot indicate sudden severe tire damage caused by outside factors and does not detect a natural, even pressure drop in all four tires. ◀

In the following situations, the system could be delayed or malfunction:

▶ When the system has not been initialized.

- ▶ When driving on snow-covered or slippery road surfaces.
- ▶ Performance-oriented style of driving: slip in the drive wheels, high lateral acceleration.
- ▶ When driving with snow chains\*.

### Initializing system

▶ The initialization is completed during driving, which can be interrupted at any time. The initialization automatically continues when driving resumes. Do not initialize the system when driving with snow chains\*. ◀

iDrive, for principle details, refer to page 16.

1. Select "Settings".
2. Select "Vehicle" and press the controller.
3. Select "Tires: FTM" and press the controller.

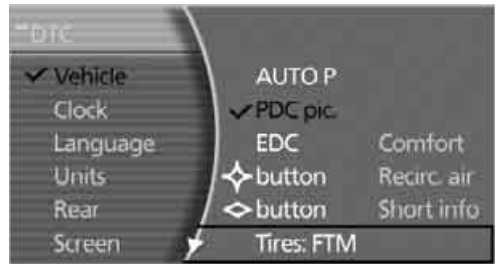

The initialization menu appears.

4. Start the engine, but do not begin to drive.
5. Select "Reset tire pressure" and press the controller.

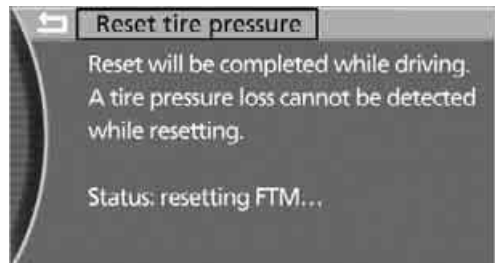

During the initialization, "Reset will be completed while driving. A tire pressure loss cannot be detected while resetting. Status: resetting FTM..." appears on the Control Display.

6. Start driving.  
It takes at least 10 minutes before the Flat Tire Monitor is once again able to detect and report a flat tire.

The initialization is completed during driving.

To exit the menu:

Select the  arrow and press the controller.

## Indication of a flat tire



The warning lamp lights up red and a message appears on the Info Display. In addition, a signal sounds. A flat tire or a major air loss has occurred.

1. Reduce speed and stop the vehicle carefully. Avoid sudden braking and steering maneuvers.
2. Identify the damaged tire.  
 If identification is not possible, contact your BMW center. ◀
3. Replace the damaged tire, refer to Changing wheels on page 215.

## Run-flat tires\*

1. Cautiously reduce the vehicle speed to below 50 mph/80 km/h. Avoid hard braking and steering maneuvers and do not exceed 50 mph/80 km/h.



If the vehicle is not equipped with run-flat tires, refer to page 205, do not continue to drive. Continued driving after a flat tire can result in serious accidents. ◀

2. Check the air pressure in all four tires at the next opportunity.



If the tire inflation pressure in all four tires is correct, the Flat Tire Monitor may not have been initialized. The system must then be initialized. ◀

3. In the event of a total loss of inflation pressure, 0 psi/kPa, or obvious tire damage, you can estimate the possible distance for continued driving on the basis of the following guide values:

- ▷ With low load:  
1 to 2 persons without luggage:  
approx. 155 miles/250 km.

- ▷ With medium load:  
2 persons, luggage compartment full, or 4 persons without luggage:  
approx. 95 miles/150 km.
- ▷ With full load:  
4 or more persons, luggage compartment full:  
approx. 30 miles/50 km.



Drive reservedly and do not exceed a speed of 50 mph/80 km/h. In the event of pressure loss, vehicle handling changes. This includes reduced tracking stability in braking, extended braking distances, and altered natural steering characteristics.

If unusual vibrations or loud noises occur while the vehicle is being driven, this can indicate final failure of the damaged tire. Reduce speed and stop at a suitable location as soon as possible; otherwise, pieces of the tire could come off and cause an accident. Do not continue driving, contact your BMW center. ◀

## Malfunction



The warning lamp lights up yellow and a message appears on the Info Display. The Flat Tire Monitor has failed. Have the system checked as soon as possible.

## TPM Tire Pressure Monitor\*

### The concept

TPM checks the tire inflation pressure in the four mounted tires. The system indicates if the tire inflation pressure has dropped considerably in one or several tires.

### Functional requirement

In order to assure the reliable reporting of a flat tire, the system must have been reset with the correct tire inflation pressure.

Always use wheels with TPM electronics; otherwise, the system cannot be assured of functioning properly.



Reset the system again after each correction of the tire inflation pressure and after every tire or wheel change. ◀

## System limits

 TPM cannot warn you of sudden serious tire damage caused by external influences. ◀

The system does not work correctly if it has not been reset; for example, a flat tire may be indicated even though the tire inflation pressures are correct.

If a wheel without TPM electronics has been mounted or if the TPM experiences temporary interference from other systems or devices that use the same radio frequency, then the system is inactive and unable to report a flat tire.

## Status display on Control Display

The tire and system status is indicated by the color of the tires.

TPM takes into account the fact that the tire pressure changes during driving. A correction is only required if the color of the TPM display indicates that it is necessary.

### Green

The tire pressure matches the learned set state. "Status: TPM active" appears on the Control Display.

### One wheel is yellow

There is a flat tire or a major drop in inflation pressure in the indicated tire. A message appears on the Control Display.

### All wheels are yellow

There is a flat tire or a major drop in inflation pressure in several tires. A message appears on the Control Display.

### Gray

The system cannot detect a flat tire.

Reasons for this can include:

- ▷ TPM is in the process of being reset
- ▷ Temporary interference due to systems or devices that use the same radio frequency
- ▷ Malfunction

## Resetting system

 Reset the system again after each correction of the tire inflation pressure and after every tire or wheel change. ◀

The reset process is completed during driving and can be interrupted at any time. When driving resumes, the process resumes automatically.

iDrive, for principle details, refer to page 16.

1. Press the **MENU** button to open the start menu.
2. Move the controller toward "Settings".
3. Select "Vehicle" and press the controller.
4. Select "Tires: TPM" and press the controller.

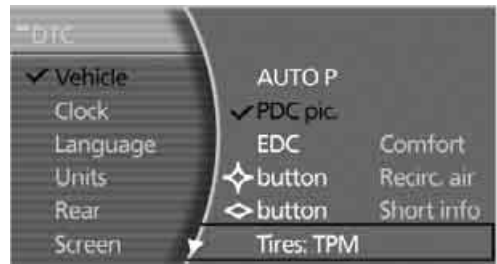

5. Start the engine, but do not begin to drive.
6. Select "RESET" and press the controller.



7. Select "YES" and press the controller.
8. Start to drive.  
The tires are shown in gray and "Status: Resetting TPM..." is displayed.

After a few minutes of driving, the newly corrected inflation pressures in the tires are adopted as the set-point values to be monitored. The resetting process is completed dur-

ing driving. The tires are displayed in green on the Control Display.

 If a flat tire is detected during the resetting and adoption of the tire inflation pressures, all tires are shown in yellow on the Control Display. The message "Status: Tire low!" is displayed. ◀

### Low tire pressure message

 The warning lamp lights up yellow. A message appears on the Control Display. In addition, a signal sounds. A flat tire or a major air loss has occurred.

1. Reduce speed and stop the vehicle carefully. Avoid sudden braking and steering maneuvers.
2. Check whether your vehicle is equipped with standard tires or run-flat tires.

 You will recognize run-flat tires by a circular symbol containing the letters RSC on the side of the tire, refer to page 205. ◀

### Standard tires

1. If all four wheels are shown in yellow, identify the damaged tire on the vehicle.
2. Replace the damaged wheel or wheels, refer to Changing wheels on page 215.

The spare wheel is equipped with the necessary TPM electronics and when mounted, will also be monitored once the system has been reset.

Have the tire replaced by a BMW center or a workshop that is familiar with handling TPM and works according to BMW repair procedures with correspondingly trained personnel.

### Run-flat tires\*

1. Cautiously reduce speed to below 50 mph/ 80 km/h. Avoid hard braking and steering maneuvers and do not exceed 50 mph/ 80 km/h.

 If the vehicle is not equipped with run-flat tires, refer to page 205, do not continue to drive. Continued driving after a flat tire can result in serious accidents. ◀

2. In the event of complete tire pressure loss, 0 psi/0 kPa, you can estimate the possible distance for continued driving on the basis of the following guide values:

- ▷ With a light load:  
1 to 2 persons without luggage:  
approx. 155 miles/250 km
- ▷ With a medium load:  
2 persons, luggage compartment full, or  
4 persons without luggage:  
approx. 95 miles/150 km
- ▷ With a full load:  
4 or more persons, luggage compartment full:  
approx. 30 miles/50 km

 Drive reservedly and do not exceed a speed of 50 mph/80 km/h. In the event of pressure loss, vehicle handling changes. This includes reduced tracking stability in braking, extended braking distance and altered natural steering characteristics.

If unusual vibrations occur while the vehicle is being driven, this can indicate final failure of the damaged tire. Reduce speed and stop as soon as possible; otherwise, pieces of the tire could come loose and cause an accident. Do not continue driving, contact your BMW center. ◀

### Malfunction

 The yellow warning light flashes and then lights up continuously. The tires are shown in gray on the Control Display and a message is displayed. No flat tire can be detected. Have system checked.

A message like this is displayed in the following situations:

- ▷ When a malfunction is occurring. Have the system checked.
- ▷ When a wheel without TPM electronics is mounted.
- ▷ When TPM is experiencing temporary interference from other systems or devices that use the same radio frequency.

## Declaration according to NHTSA/ FMVSS 138 Tire Pressure Monitoring Systems

Each tire, including the spare, should be checked monthly when cold and inflated to the inflation pressure recommended by the vehicle manufacturer on the vehicle placard or tire inflation pressure label. If your vehicle has tires of a different size than the size indicated on the vehicle placard or tire inflation pressure label, you should determine the proper tire inflation pressure for those tires. As an added safety feature, your vehicle has been equipped with a tire pressure monitoring system TPMS that illuminates a low tire pressure indicator lamp when one or more of your tires are significantly under-inflated. Accordingly, when the low tire pressure indicator lamp comes on, you should stop and check your tires as soon as possible, and inflate them to the proper pressure. Driving on a significantly under-inflated tire causes the tire to overheat and can lead to tire failure. Underinflation also reduces fuel efficiency and tire tread life, and may affect the vehicle's handling and stopping ability. Please note that the TPMS is not a substitute for proper tire maintenance, and it is the driver's responsibility to maintain correct tire pressure, even if underinflation has not reached the level to trigger illumination of the TPMS low tire pressure indicator lamp.

The TPMS malfunction indicator is combined with the low tire pressure indicator lamp. When the system detects a malfunction, the indicator lamp will flash for approximately one minute and then remain continuously lit. This sequence will continue upon subsequent vehicle startups as long as the malfunction exists. When the malfunction indicator is illuminated, the system may not be able to detect or signal low tire pressure as intended. TPMS malfunctions may occur for a variety of reasons, including the installation of replacement or alternate tires or wheels on the vehicle that prevent the TPMS from functioning properly. Always check the TPMS malfunction indicator lamp after replacing one or more tires or wheels on your vehicle to ensure that the replacement or alternate tires

and wheels allow the TPMS to continue to function properly.

## Brake force display



Left: normal braking.

Right: heavy braking.



# Airbags



The following airbags are located under the marked covers:

- 1 Front airbags
- 2 Head airbags
- 3 Side airbags in front and rear\*
- 4 Knee airbags

## Protective action

 To ensure that the safety systems continue to provide optimized protection, please follow the adjustment instructions on page 43. ◀

The front airbags help protect the driver and front passenger by responding to frontal impacts in which safety belts alone cannot provide adequate restraint. When needed, the head and side airbags help provide protection in the event of side impact. The relevant side airbag supports the side upper body area. The head air bag supports the head. The knee airbags help protect the legs against impact against the cockpit.

The airbags are deliberately not triggered in every impact situation, e.g. less severe accidents or rear-end collisions.

 Do not apply adhesive materials to the cover panels of the airbags, cover them or modify them in any other way. Do not attempt to remove the airbag retention system from the vehicle. Never modify or tamper with either the wiring or the individual components in the airbag system. This category includes the upholstery in the center of the steering wheel, on the instrument panel, the doors and the roof pillars along with the sides of

the headliner. Do not attempt to remove or dismantle the steering wheel.

Do not touch the individual components directly after the system has been triggered, because there is a danger of burns. In the event of malfunctions, deactivation, or triggering of the airbag restraint system, have the testing, repair, removal, and disposal of airbag generators executed only by a BMW center or a workshop that works according to BMW repair procedures with correspondingly trained personnel and has the required explosives licenses. Unprofessional attempts to service the system could lead to failure in an emergency or undesired airbag activation, either of which could result in personal injury. ◀

Warnings and information about the airbags is also provided on the sun visors.

## Automatic deactivation of front passenger airbags

The occupation of the seat is detected by evaluating the impression on the occupied seat surface of the front passenger seat. The system appropriately activates or deactivates the front, knee, and side airbag on the front passenger side.

 The current status of the front passenger airbag, i.e. deactivated or activated, is indicated by the indicator lamp over the interior rearview mirror, refer to Operating state of front passenger airbags in the following. ◀

 Before transporting a child on the front passenger seat, pay attention to the safety information and follow the handling instructions under Transporting children safely,

refer to page 54.

In certain sitting positions, teenagers and adults can deactivate the front, knee and side airbag on the front passenger side; when this occurs, the indicator lamp for the front passenger airbags lights up. In these cases, change the sitting position so that the front passenger airbags are activated and the indicator lamp goes out. If the desired status cannot be produced by changing the sitting position, have the person ride in the back. Do not place slip covers, seat cushions, beaded mats, or other objects on the passenger seat that are not specifically recommended by BMW. Do not lay objects under the seat which could press against the seat from below. Otherwise, a correct evaluation of the occupied seat surface cannot be assured. ◀

### Operating state of front passenger airbags



The indicator lamp for the front passenger airbags indicates the operational status of the front, knee and side airbag on the front passenger side depending on whether the seat is occupied. The indicator lamp shows whether the front passenger airbags are activated or deactivated.

- ▷ The indicator lamp lights up when a child properly seated in a child restraint system intended for the purpose is detected on the seat.

Front, knee and side airbag on the front passenger side are deactivated.



Most child seats are detected by the system. It is particularly advisable to use child seats approved by NHTSA at the time that the vehicle was produced. After installing a child's seat, make sure that the

indicator light for the front passenger airbags is illuminated. This indicates that the system has detected the child's seat and has deactivated the front passenger airbags. ◀

- ▷ The indicator lamp does not light up when, for example, a correctly seated person of sufficient height is detected on the seat. Front, knee and side airbag on the front passenger side are activated.
- ▷ The indicator lamp does not light up when the seat is empty. The front, knee, and side airbags on the front passenger side are not activated in this case either.

### Operational readiness of the airbag system



Once the radio ready position is reached, the warning lamp lights up briefly, thus indicating the operational readiness of the entire airbag system and the safety belt tensioners.

### Airbag system malfunction

- ▷ Warning lamp does not light up from radio ready state.
- ▷ Warning lamp lights up continuously.



Have the airbag system checked immediately in case of a malfunction; otherwise, there is a danger that the airbag system may not respond in the expected manner in an accident despite an impact of corresponding intensity. ◀

# BMW Night Vision\*

## The concept

BMW Night Vision is a driver assistance system that is designed to provide enhanced vision for certain objects at night. This can be especially helpful for detecting people and larger animals. When objects are detected, the driver may be able to take appropriate action sooner. For example, the driver may identify and detect the presence of persons or animals in the road ahead or off to the sides and can be more alert, slow down or stop, blow the horn, etc. The driver can decide which actions are appropriate and then react accordingly.

A certain area in front of the vehicle is viewed by an infrared camera and a generated image is shown on the Control Display. The resulting thermal image shows the relative heat radiation of the objects present in the camera's field of view. Warmer objects appear brighter and cooler objects appear darker. Contrast is dependent on the temperature difference between the objects and the background and on the amount of heat radiation of the object itself. As a result, it is quite possible that a person is not continually recognizable as a person in shape, since the thermal radiation can be affected by different clothing which blocks heat loss. Objects with little temperature difference to the surrounding area, or little heat radiation are less noticeable, for example in cold weather.

Any improvement in detection depends on many factors such as the object size and temperature compared to the surroundings, or other nearby objects, the visual recognition skills of the driver, weather conditions, and other factors.

## Driving hints

With the system active, periodically but briefly, glance at the thermal image on the Control Display to notice objects that could be people or larger animals. The glance should be similar to glancing at the rear view mirror. Do not stare at the image for long periods while driving, as this will take your attention away from the road. If

you notice an object of interest ahead, be prepared to slow down or stop, blow the horn, or take other appropriate action.

## System limits

The system is designed to supplement but not replace forward vision through the windshield. The driver is responsible for safe driving at night. BMW Night Vision is not designed to be used as a continuous viewing window for driving at night.

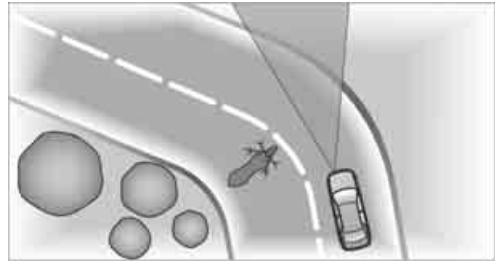



No system, no matter how sophisticated, can operate without limitations. BMW Night Vision operation is subject to physical and environmental limitations that will reduce the ability of the system to detect and display a clear thermal image. Some of the situations in which these limitations can occur are:

- ▶ on steep hilltops or depressions and in tight curves
- ▶ in tunnels, as the contrast is inherently low
- ▶ when the camera lens is dirty
- ▶ in dense fog, heavy rain or snowfall
- ▶ when displaying very hot objects such as transformers, car exhausts etc.
- ▶ when the image briefly freezes during normal system adjustment.

 BMW Night Vision's potential benefits can be limited by the driving style of the driver, the size and relative temperature of the detected objects, dirt or contamination on the camera lens, adverse weather like snow, rain, or fog, and other factors not mentioned here. It will always be the driver's responsibility to drive at a speed and in a manner that recognizes potential hazards and to adjust accordingly.

BMW Night Vision is not a substitute or replacement for driver responsibility or for adapting to the visibility conditions and the traffic situation. The forward view illuminated by the headlamps must always be the basis for making safe driving decisions; otherwise, a safety risk will result. ◀

### Activating BMW Night Vision

1. Turn the light switch to position **2** or **3**, refer to page [100](#).
2. When the low beams are switched on:
  - ▷ Press the  button.
  - ▷ Press the  button. Programming button on the steering wheel, refer to page [52](#).



The image will be displayed on the Control Display after a few seconds. Depending on the last mode selected, either the normal or full screen image will be displayed.





Due to the system's need to adjust periodically, a still image is displayed at certain intervals for fractions of a second. This is normal and not an indication of a problem.

To prevent driving without headlamps, at a speed of more than approx. 3 mph/5 km/h and when dark, the thermal image on the Control

Display is only shown when the low beams are on.

▷ BMW Night Vision is not available on the rear screen. When the system is active, neither the navigation system nor BMW Assist can be started from the rear screen. ◀

### Deactivating BMW Night Vision

- ▷ Press the  button.
- ▷ Press the  button.
- ▷ Press the **MENU** button.
- ▷ Make a selection with the controller, i.e.: change the radio station or make a phone call. For iDrive details, refer to page [16](#).

### Selecting settings

1. Activate BMW Night Vision.
2. Press the controller to display the menu items.



3. Select the menu item and press the controller:

- ▷ "Zoom":  
At higher speeds, the image is zoomed in.
- ▷ "Curve mode":  
Depending on the steering angle and other parameters, the image section follows the course of the road to some degree.
- ▷ "Full screen":  
The image is shown on the entire Control Display.
- ▷ "Contrast":  
The contrast of the screen can be adjusted, refer to page [172](#).

▷ "Brightness":

The brightness of the screen can be adjusted, refer to page 172.

The settings are stored for the remote control currently in use.

To exit the menu:

The image will automatically disappear after approx. 5 seconds, or select the  return arrow and press the controller to exit sooner.

## Cleaning camera



The function of the camera may be affected by heavy rain and fog, dirt, snow or ice on the lens. When this occurs, the displayed image on the Control Display may become gray.

To minimize icing the camera lens is automatically heated. However, it may be necessary to clean the camera lens manually under severe weather conditions. When doing so, cautiously remove any debris, ice or snow. To avoid damage to the lens, do not use sharp or abrasive instruments to clean ice, snow, or dirt off the lens.

When the windshield is cleaned with the headlamps on, the camera lens area is automatically sprayed as well. Refer to page 65.

# Lamps

## Parking lamps/low beams



- 0** Lamps off and daytime running lamps\*
- 1** Parking lamps and daytime running lamps\*
- 2** Low beams
- 3** Automatic headlamp control, daytime running lamps\* and Adaptive Head Light\*

If you open the driver's door when the ignition is switched off, then the exterior lighting is switched off if the light switch is in position **0**, **2** or **3**.

### Parking lamps

In switch position **1**, the front, rear and side vehicle lighting is switched on. You can use the parking lamps for parking.

 The parking lamps drain the battery. Do not leave them switched on for long periods of time; otherwise, it may no longer be possible to start the engine. It is preferable to switch on the left-hand or right-hand roadside parking lamps, refer to page [101](#). ◀

### Low beams

The low beams light up when the light switch is in position **2** and the ignition is on.

### Automatic headlamp control

In the switch position **3**, the system activates the low beams and switches them on or off in response to changes in ambient light conditions, for example in a tunnel, at dawn and dusk, and in case of precipitation. The LED next to the

symbol is illuminated when the low beams are on.

The low beams may be switched on when the sun is low on the horizon in a clear sky.

 The low beams remain switched on regardless of the ambient light when you switch on the front fog lamps. ◀

 The automatic headlamp control cannot serve as a substitute for your personal judgment in determining when the lamps should be switched on in response to ambient lighting conditions. For example, the sensors cannot detect fog or hazy weather. To avoid safety risks, you should always switch on the lamps manually under these conditions. ◀

### Pathway lighting

After parking the vehicle and switching off the headlamps, you can use the headlamp flasher control to activate the low beams for a period of roughly 40 seconds.

Pressing the  button on the remote control, refer to page [32](#), also switches on the low beams for approx. 40 seconds. In addition, the door handle and interior lamps are switched on for approx. 10 seconds.

### Daytime running lamps\*

The daytime running lamps light up in position **0**, **1** or **3**. The light output is lower than with the low-beam headlamps.

If the light switch remains in position **1**, then the parking lamps are lit after the ignition is switched off.

## Adaptive Head Light\*

### The concept

Adaptive Head Light is a variable headlamp control system that enables dynamic illumination of the road surface. Depending on the steering angle and other parameters, the light

from the headlamp follows the course of the road.

### Activating Adaptive Head Light

In switch position **3**, the Adaptive Head Light is activated and Automatic headlamp control is switched on.

In order not to blind oncoming traffic, the Adaptive Head Light is not active when driving in reverse and only points toward the passenger side when the vehicle is stationary.

### Malfunction

The LED above the symbol for automatic headlamp control flashes. Adaptive Head Light is malfunctioning or has failed. Have the system checked as soon as possible.

## High beams/ roadside parking lamps

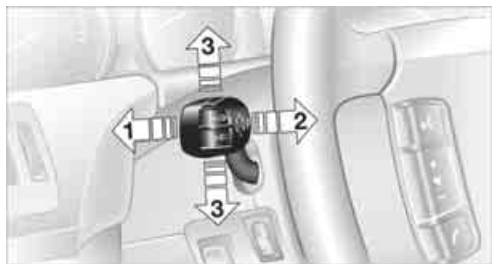

- 1 High beams
- 2 Headlamp flasher
- 3 Roadside parking lamps

### Roadside parking lamps, left and right\*

You also enjoy the option of lighting up just one side of your vehicle when parking:

After parking the vehicle, press the lever in the desired direction **3**, past the resistance point.

 The roadside parking lamps drain the battery. Do not leave them switched on for long periods of time; otherwise, it may no longer be possible to start the engine. ◀

## Front fog lamps



Briefly press the button to switch on/off.

The parking lamps or low beams must be switched on for the fog lamps to operate. The green indicator lamp on the Info Display lights up whenever the fog lamps are on.

 If the automatic headlamp control is activated, the low beams will come on automatically when you switch on the fog lamps. ◀

## Instrument lighting



You can adjust the lighting intensity with the knurled wheel.

## Interior lamps

The interior lamps, footwell lamps, door entry lighting, the perimeter lighting, and the luggage compartment lamps are controlled automatically.

## Switching interior lamps on and off



Briefly press the button.

If you wish the interior lamps, footwell lamps, door entry lighting, and the perimeter lighting to stay off, press and hold the button for approx. 3 seconds.

To revert to normal operation, briefly press the button.

The button for the interior lamps in the rear passenger area only switches these lamps on and off.

## Reading lamps

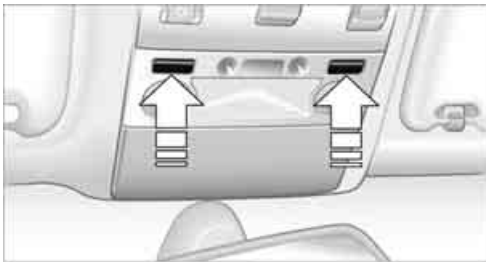

Reading lamps are provided in the front and rear, adjacent to the interior lamps. They can be switched on and off with the respective button located next to them.

 To avoid discharging the battery, all of the vehicle's interior lamps are automatically extinguished approx. 15 minutes after the ignition is switched off. ◀



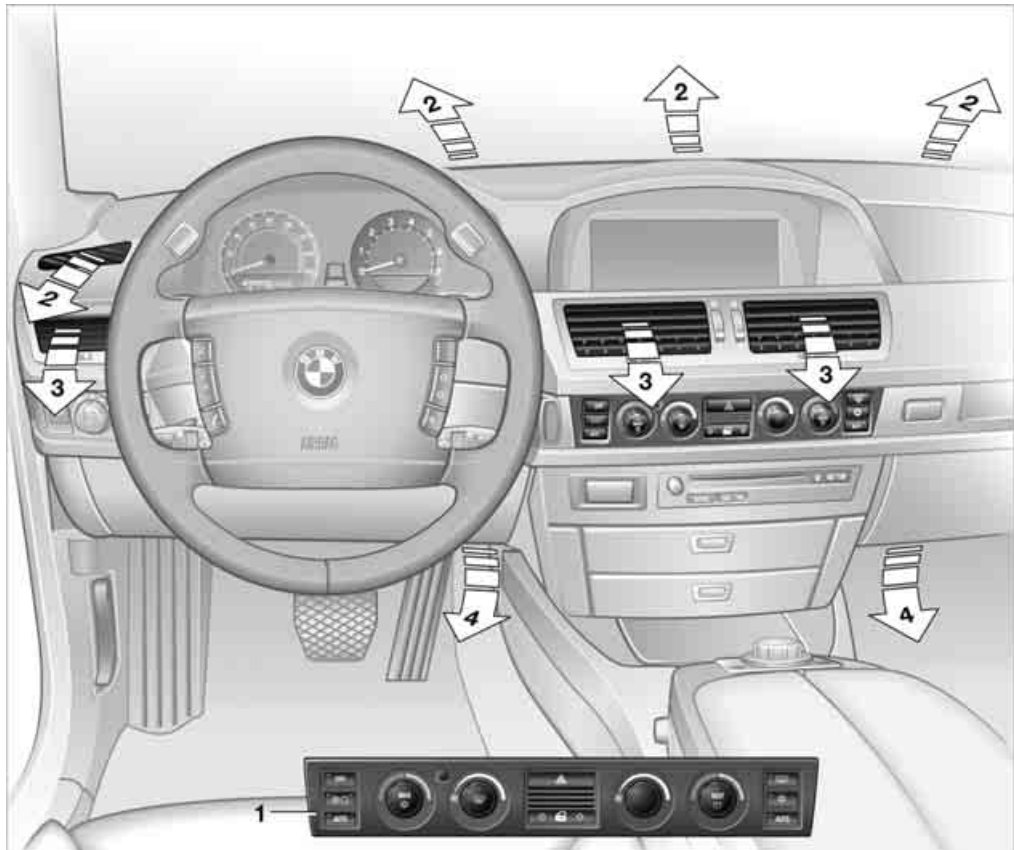

- 1 Automatic climate control
- 2 Air directed toward the windshield and side windows
- 3 Air for upper body area  
The knurled wheels in the center open and close through an infinitely variable range to control air supply while also adjusting the air's direction, like the lower knurled wheels. You can find more information on adjusting for draft-free ventilation on page [107](#).
- 4 Air to footwell

## Automatic climate control



- 1 AUTO program, left side of passenger compartment, refer to section below
- 2 Outside air/AUC Automatic recirculated-air control/recirculated air [105](#)
- 3 Switching off automatic climate control [105](#)
- 4 Temperature, left side of passenger compartment [105](#)
- 5 Maximum cooling [106](#)
- 6 Air volume, left side of passenger compartment [106](#)
- 7 Defrosting windows and removing condensation [106](#)
- 8 Air volume, right side of passenger compartment [106](#)
- 9 Temperature, right side of passenger compartment [105](#)
- 10 Residual heat mode [106](#)
- 11 Rear window defroster [107](#)
- 12 Switching cooling function on and off manually [107](#)
- 13 AUTO program, right side of passenger compartment, refer to section below
- 14 Air grille for interior temperature sensor – please keep clear and unobstructed
- 15 Parked car ventilation [109](#)
  - ▷ lights up: activation time activated
  - ▷ flashes: parked car ventilation switched on

The current setting for air distribution appears on the Control Display, refer to page [106](#).

### A congenial climate

For almost all conditions, the AUTO program [1](#) offers the optimal air distribution and air volume. Select an interior temperature that you find pleasant.

The following section contains more detailed information on the available setting options.

The settings are stored for the remote key currently in use.

### AUTO program

The AUTO program handles the adjustment of air distribution to the windshield and side windows, in the direction of the upper body, and in the footwell, as well as the adjustment of the air volume.

It also adapts your instructions for the temperature to outside influences throughout the year.

The cooling is switched on automatically with the AUTO program. At the same time, a condensation sensor controls the program so as to prevent window condensation as much as possible.

### Intensity of AUTO program

You can adjust the intensity of the AUTO program by repeatedly pressing the AUTO button. Press the button to have the current setting briefly displayed on the lower status line of the Control Display.

You can also adjust the intensity of the AUTO program via iDrive.

iDrive, for principle details, refer to page 16.

1. Press the **MENU** button to open the start menu.
2. Move the controller toward "Climate".
3. Turn the controller to select driver's side or passenger side.
4. Turn the controller to select the field.
5. Press the controller repeatedly until the desired program is displayed:
  - ▷ "low"
  - ▷ "medium"
  - ▷ "high"



### Automatic recirculated air control/ recirculated air mode

 You can respond to unpleasant odors or pollutants in the immediate environment by temporarily suspending the supply of outside air. The system then recirculates the air currently within the vehicle. In AUC mode, a sensor detects pollutants in the outside air and controls the shut-off automatically.

Press the button repeatedly to run through the following control sequence:

- ▷ LEDs off: outside air flows into the vehicle continuously.
- ▷ Left LED on, AUC mode: the system detects pollutants in the outside air and responds by blocking the supply of outside air when required.
- ▷ Right LED on, recirculated-air mode: the supply of outside air into the vehicle is continuously blocked.

 If the windows fog over in recirculated-air mode, then press the AUTO button or switch off the recirculated-air mode and increase the air quantity as needed.

The recirculated-air mode should not be used over a longer period of time, as the air quality inside the vehicle deteriorates continuously. ◀

### Automatic climate control, switching on and off

 The air volume, the heater, and the air conditioner mode are all switched off.

You can restart the automatic climate control by pressing any of its buttons except the REST button.

### Temperature adjustment



Adjust the desired temperature individually on the driver's side and passenger side. Your settings appear on the status line of the Control Display.

The automatic climate control achieves this temperature as quickly as possible at any time of year, if necessary with the maximum cooling or heating capacity, and then keeps it constant.

 When switching between different temperature settings in rapid succession, the automatic climate control does not have sufficient time to achieve the set temperature. ◀

The highest setting switches on the maximum heat output regardless of the outside temperature. The lowest setting activates maximum air conditioning.

### Using iDrive

1. Open the start menu.
2. Open "Climate".
3. Turn the controller to select driver's side or passenger side.
4. Turn the controller to select the field and press the controller.

- Turn the controller to adjust the temperature:
  - ▷ Turn toward the left, toward blue: colder
  - ▷ Turn toward the right, toward red: warmer



- Press the controller to save the setting.

## Maximum cooling



Maximally cooled air is obtained as quickly as possible at an outside temperature of approx. 32 °F / 0 °C and with the engine running.

The automatic climate control changes over to the lowest temperature and switches into the recirculated-air mode. The maximum air quantity only flows out of the vents for the upper body. So open these vents for maximum cooling.

## Air volume



You can vary the air volume by turning. You can reactivate the automatic air supply mode by pressing the AUTO button.

## Manual air distribution

You can adapt the air distribution to your own personal preferences:

- Open the start menu.
- Open "Climate".
- Turn the controller to select driver's side or passenger side.

- Select the desired field and press the controller.

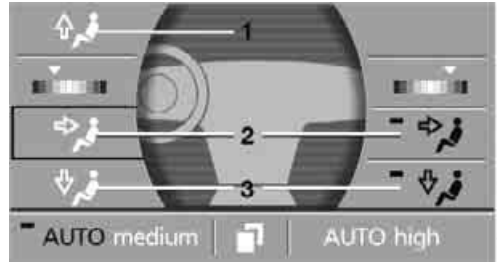

- Air directed toward the windshield and side windows
- Air to the upper body
- Air to footwell

You can only use the condensation sensor in the AUTO program. Press the AUTO button when you notice condensation on windows and wish to take advantage of the condensation sensor.

## Defrosting windows and removing condensation



Quickly remove ice and condensation from the windshield and front side windows. Also switch on the air conditioner.

## Residual heat



The system uses the warmth stored in the engine to heat the interior when the ignition is off, e.g. while the vehicle is stopped at a school to pick up a child.

The function can be switched on when the following conditions are met:

- ▷ up to 15 minutes after switching off the engine
- ▷ with the engine at operating temperature
- ▷ with sufficient battery voltage
- ▷ at an outside temperature below 77 °F / 25 °C

The LED lights up when the function is switched on.

The interior temperature, air volume, and air distribution can be set starting from the radio ready state.

## Switching cooling function on and off manually



When activated, the air conditioner mode cools and dehumidifies the incoming air, reheating it as required, depending on the temperature setting. Depending on the weather, the windshield may fog over briefly when the engine is started. The cooling function is switched on automatically with the AUTO program. The passenger compartment can only be cooled with the engine running.

## Rear window defroster



The rear window defroster switches off automatically after a while. Depending on your equipment package, the upper wires are used as an antenna and are not part of the rear window defroster.

## Front ventilation

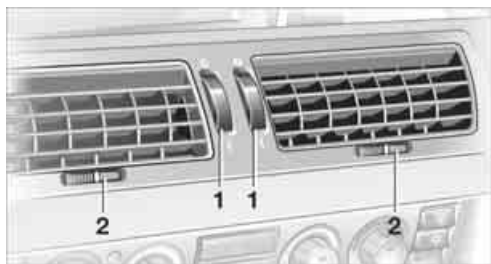

- 1 Knurled wheels for smoothly opening and closing the air vents
- 2 Knurled wheels for changing airflow direction

## Ventilation for cooling

Adjust the vents to direct the flow of cool air in your direction, for instance, if the interior has become too warm, etc.

## Draft-free ventilation

Set the vent outlets so that the air flows past you and is not directed straight at you.

## Ventilation in rear



- 1 Knurled wheel for smoothly opening and closing the air vents

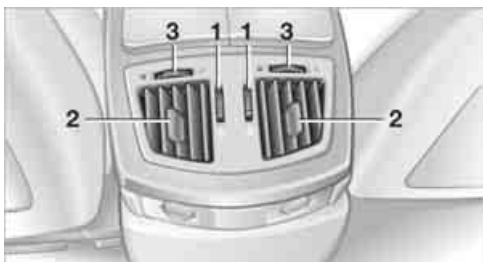

- 1 Knurled wheels for smoothly opening and closing the air vents
- 2 Levers for changing airflow direction
- 3 Knurled wheels\* for setting temperature:
  - ▷ Turn toward blue: colder
  - ▷ Turn toward red: warmer

## Microfilter/activated-charcoal filter

The microfilter removes dust and pollen from the incoming air. The activated-charcoal filter provides additional protection by filtering gaseous pollutants from the outside air. Your BMW center replaces this combined filter as a standard part of your scheduled maintenance. You can select a display of more detailed information in the service required display, refer to page 78.

## Rear climate control\*

The following settings and operating modes can be selected and adjusted separately on the left and right sides:

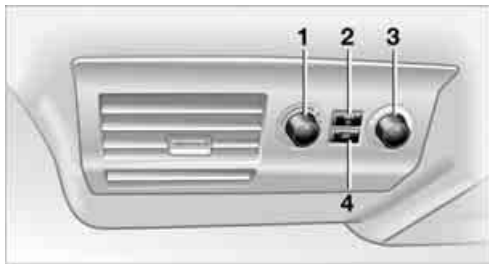

- 1 Adjusting cooling
- 2 Maximum cooling
- 3 Air volume
- 4 Switching off

### Switching on

- ▷ Select maximum cooling **2**
- ▷ Press the OFF button **4**
- ▷ Via iDrive, refer to Switching on/off via iDrive

### Adjusting cooling



You can also set the system to the desired level of cooling by turning. We recommend setting the system for moderate cooling. When you start the vehicle, this system ensures that the selected setting is achieved as quickly as possible. It then maintains this temperature, regardless of the season.

### Air volume



You can vary the air volume by turning.

### Maximum cooling



This program quickly provides maximum cooling.

The system automatically switches to the recirculated-air mode and the maximum air volume

flows from the ventilation grilles. So open these vents for maximum cooling.

### Switching off



The system is switched off.

Press the button again to switch back on.

### Switching on/off via iDrive

iDrive, for principle details, refer to page 16.

1. Press the **MENU** button to open the start menu.
2. Move the controller toward "Climate".
3. If need be, select the  symbol and press the controller to switch to the other side of the menu.
4. Select "Extra" and press the controller.
5. Select "Rear climate control" and press the controller.



- ▷ The maximum cooling mode is automatically activated when you switch on the rear climate control via iDrive. ◀

To switch off, select "Rear climate control" again and press the controller.

## Ventilation in rear



Use the lever **1** to vary the airflow direction. For additional information on rear ventilation options, refer to page [107](#).

## Parked car ventilation

The parked car ventilation blows air into the passenger compartment to reduce interior temperatures.

You can set two different times for the system to start. The system is operated via iDrive. It remains switched on for 30 minutes.

Since the system uses a substantial amount of electrical current, you should refrain from activating it twice in succession without allowing the battery to be recharged in normal operation between uses.

With a preselected switch-on time, the parked car ventilation is switched on at an outside temperature of 59 °F / 15 °C or greater. When operated manually, it is ready for use at any outside temperature, but not during driving.

The air enters the passenger compartment through the air vents for the upper body in the dashboard, which can be adjusted for both direction and airflow. These vents must be open for the system to operate.

## Switching on and off directly

iDrive, for principle details, refer to page [16](#).

1. Press the **MENU** button to open the start menu.
2. Move the controller toward "Climate".
3. If need be, select the  symbol and press the controller to switch to the other side of the menu.
4. Select "Parked car " and press the controller.
5. Select "Indep. ventil. " and press the controller.



- ✓ The parked car ventilation is switched on.
-  LED on the automatic climate control flashes.
6. Select "Indep. ventil." again and press the controller to switch off.

## Preselecting activation time

iDrive, for principle details, refer to page [16](#).

1. Press the **MENU** button to open the start menu.
2. Move the controller toward "Climate".
3. If need be, select the  symbol and press the controller to switch to the other side of the menu.
4. Select "Parked car" and press the controller.
5. Select "Set time 1" or "Set time 2" and press the controller.

6. Enter the desired time:
  - ▷ Turn to change the setting.
  - ▷ Press the controller to adopt the setting.

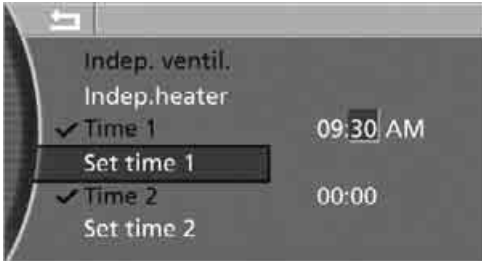

### Activating timer

iDrive, for principle details, refer to page 16.

1. Press the **MENU** button to open the start menu.
2. Move the controller toward "Climate".
3. If need be, select the  symbol and press the controller to switch to the other side of the menu.
4. Select "Parked car" and press the controller.
5. Select "Time 1" or "Time 2" and press the controller.

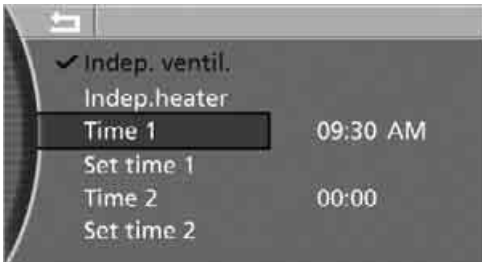

- ✓ The activation time is activated.
- ⚙️ LED on the automatic climate control lights up.
- ⚙️ LED on the automatic climate control flashes when the system has switched on.
- ▷ The parked car ventilation is only available for activation within the next 24 hours. After this, the time will have to be reconfirmed. ◀



# Practical interior accessories

## Integrated universal remote control\*

### The concept

The integrated universal remote control can replace as many as three hand-held transmitters for various radio-controlled accessories, such as garage doors, entrance gates, or lighting systems. The integrated universal remote control registers and stores signals from the original hand-held transmitters.

The signal of an original hand-held transmitter can be programmed into one of the three memory buttons **1**. After this, the programmed memory button **1** will operate the system in question. The LED **2** flashes to confirm transmission of the signal.

Should you sell your vehicle one day, be sure to delete the stored programs beforehand for your security, refer to page [112](#).

 To prevent possible damage or injury, during programming or before each use of the programmed device by the integrated universal remote control, always inspect the immediate area to make certain that no people, animals or objects are within the swiveling and movement range of the device. Also, comply with the safety precautions of the original hand-held transmitter. ◀

### Checking compatibility

 If you see this symbol on the packaging or in the manual supplied with the original hand-held transmitter, then it is safe to assume that it is compatible with the integrated universal remote control.

 If you have additional questions, please contact your BMW center or call: 1-800-355-3515.

Information is also provided on the Internet at: [www.bmwusa.com](http://www.bmwusa.com) or [www.homelink.com](http://www.homelink.com).

HomeLink is a registered trademark of Johnson Controls, Inc. ◀

### Programming

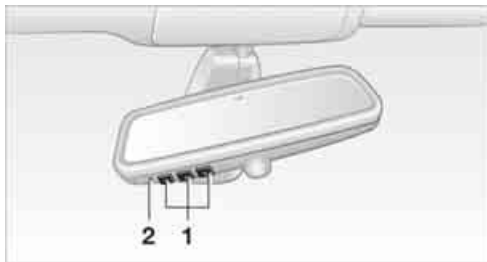

- 1 Memory buttons
- 2 LED

### Fixed-code hand-held transmitters

1. Switch on the ignition, refer to page [57](#).
2. When using for the first time: Press the left and right memory buttons **1** for approx. 20 seconds until the LED **2** flashes rapidly. All stored programs are deleted.
3. Hold the original hand-held transmitter at a distance of approx. 4 in/10 cm to 12 in/30 cm from the memory buttons **1**.  
 The required distance between the hand-held transmitter and memory buttons **1** depends on the relevant system of the original hand-held transmitter used. ◀
4. Simultaneously press the transmit button on the original hand-held transmitter and the desired memory button **1** of the integrated universal remote control. The LED **2** flashes slowly at first. As soon as the LED **2** flashes rapidly, release both buttons. If the LED **2** does not flash rapidly after approx. 15 seconds, alter the distance and repeat the step.
5. To program other original hand-held transmitters, repeat steps 3 and 4.

The corresponding memory button **1** is now programmed with the signal of the original hand-held transmitter.

You can operate the system when the engine is running or when the ignition is switched on.

 If the device cannot be used after repeated programming, check whether the original hand-held transmitter uses an alternating-code system. To do so, either read the instructions of the original hand-held transmitter or press and hold down the programmed memory button **1** of the integrated universal remote control. If the LED **2** on the integrated universal remote control flashes rapidly for a short time and then remains lit for approx. 2 seconds, then this indicates that the original hand-held transmitter is equipped with an alternating-code system. In the case of an alternating-code system, program the memory buttons **1** as described in the Alternating-code hand-held transmitters section below. ◀

## Alternating-code hand-held transmitters

Consult the operating instructions of the unit you wish to set when programming the universal remote control. You will find information there on the possibilities for synchronization. When programming hand-held transmitters that employ an alternating code, please follow the supplementary instructions below:

 Programming will be easier with the aid of a second person. ◀

1. Park your vehicle within the range of the remote-controlled device.
2. Program the integrated universal remote control as described above in the Fixed-code hand-held transmitters section.
3. Locate the button on the receiver of the device you want to set up, e.g. on the upper section of its drive unit.
4. Press the button on the receiver of the device you want to set up. After step 4, you have approx. 30 seconds for step 5.

5. Press the programmable memory button **1** on the integrated universal remote control three times.

The corresponding memory button **1** is now programmed with the signal of the original hand-held transmitter.

 If you have any additional questions, please contact your BMW center. ◀

## Deleting stored programs

Press the left and right memory buttons **1** for approx. 20 seconds until the LED **2** flashes rapidly:

All stored programs are deleted.

It is not possible to delete individual programs.

## Roller sun blinds\*

### Rear window blind



Briefly press the button on the driver's door with the ignition in radio ready state or higher.

### Roller sun blinds for rear side windows

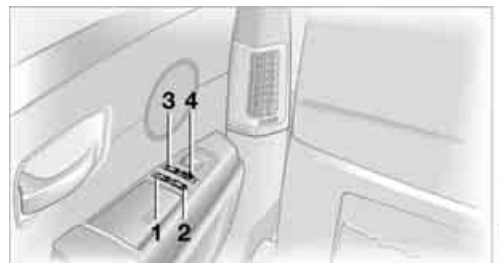

- 1 Quarter window blind
- 2 Side window blind
- 3 Rear window blind

#### 4 Switching to the other side

Briefly press the corresponding button with the ignition in radio ready state or higher.

 The side window blind can not be extended unless the side window is closed. If the side window is open, the blind will rise slightly prior to immediately retracting to its original position. ◀

 To avoid injuries, make sure that the closing region of the roller blind is clear. Press the safety switch on the driver's door, refer to page 40. The LED must light up. This precaution prevents children from operating the sun blinds using the rear switches, etc. When leaving the vehicle parked, remove the remote control from the ignition lock and close the doors; this precaution prevents children from operating the roller sun blinds and injuring themselves. ◀

### Automatically extending and retracting sun blinds

You can run the sun blinds up and down together when you press and hold the button 3 longer.

## Glove compartment

### Releasing

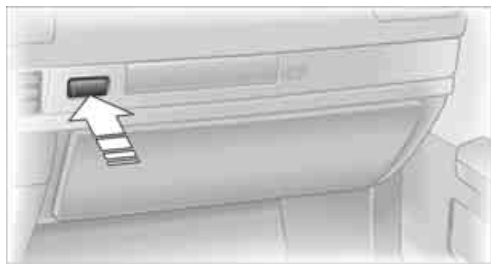

Press button. The glove compartment opens automatically and the light comes on.

### Closing

Fold the cover up.

 To prevent injury in the event of an accident while the vehicle is being driven, close the glove compartment immediately after use. ◀

### Rechargeable flashlight



The flashlight is located on the left side of the glove compartment.

The flashlight can remain plugged in continuously. Remove the flashlight from the socket when needed.

 Be sure that the flashlight is switched off when it is inserted into its holder. Failure to comply with this precaution could lead to overcharging and damage. ◀

## Front center armrest



A storage compartment is located in the center armrest between the front seats. Briefly press the buttons to open.

- 1 Open the right cover
- 2 Open the left cover

The mat inside the compartment can be removed for cleaning.

Depending upon your equipment package, any of the following may be located in the storage compartment:

- ▷ Removable CD holder\*
- ▷ Folding, removable storage compartment\*, e.g. for glasses or mobile phone
- ▷ Folding, removable waste receptacle\*

## Locking storage compartment

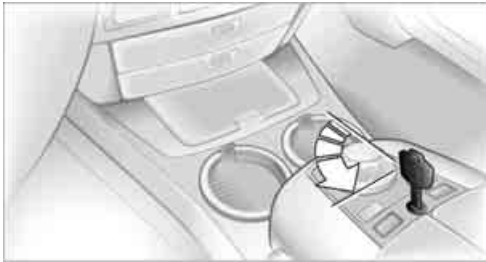

You can use the key to lock the storage compartment in the armrest.

- ▷ For example at a hotel, if you want to lock the luggage compartment lid separately, refer to page 35. Then lock the armrest storage compartment and surrender only the remote control without the key, refer to page 30. This prevents unauthorized access to the armrest storage compartment and the luggage compartment. ◀

## Ventilating storage compartment

You can use the knurled wheel in the storage compartment to open and close the vent.

- ▷ Depending on the automatic climate control setting, the temperature in the storage compartment may be higher than in the rest of the passenger compartment. Close the vent as required. ◀

The temperature in the storage compartment depends on the setting for the upper body area, refer to page 105.

## Connection for external audio device

You can connect an external audio device such as a CD or MP3 player and play the sound over the vehicle's speaker system, refer to page 169.

## Center armrest, rear

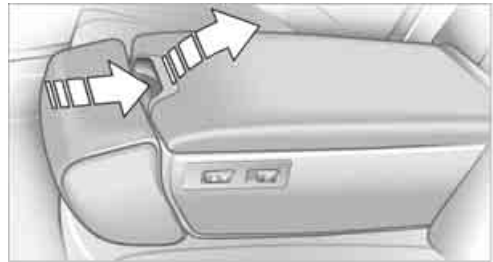

- ▷ Before folding down the armrest, adjust the head restraint to its lowest position, refer to page 48. ◀

To open the storage compartment: Press the button in the handle recess and fold up the cover.

## Rear comfort seat\*



- ▷ Before folding down the armrest, adjust the head restraint to its lowest position, refer to page 48. ◀

To open the storage compartment: Press the button and fold up the cover.

## Storage compartments

### Clothes hooks

Clothes hooks are located near the grab handles in the rear.

- ⚠ When suspending clothing from the hooks ensure that it will not obstruct the driver's vision. Do not hang heavy objects on the hooks. If you do so, they could cause personal injury to occupants during braking or evasive maneuvers. ◀

## Glasses compartment



Briefly press the button to open.  
You can remove the insert tray for cleaning.

## Storage compartment in center console



Briefly press the button to open.

## Cup holders

### Front



Below the sliding covers.

 Do not place glass containers in the cup holders; otherwise, there is a danger of injury in an accident. ◀

## Rear

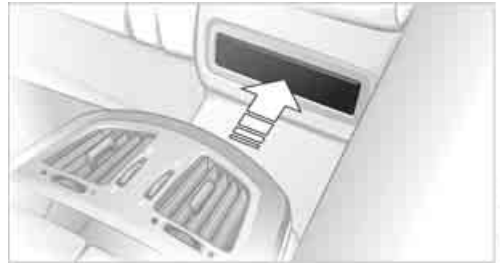

In the front of the rear seat cushion's center.  
Briefly press to open; slide back to close.

## Ashtray, front

### Opening

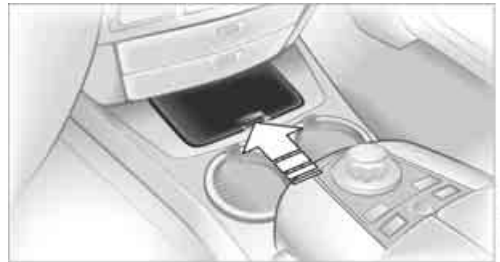

Push cover on recess toward front.  
To extinguish a cigarette, tap off the ash and gently press the tip into the funnel.

### Emptying



Press the button, refer to arrow. The ashtray lifts up and can be removed.

## Cigarette lighter, front



Push down.

The lighter can be removed as soon as it pops back out.

**⚠** Hold or touch the hot cigarette lighter by the knob only. Holding or touching it in other areas could result in burns. The cigarette lighter works even if the remote control has been removed from the ignition. For this reason, do not leave children unattended in the vehicle; otherwise, there is a chance they could injure themselves. ◀

### Power socket

With the ignition switched on, the cigarette lighter socket can be used to plug in hand flashlights, car vacuum cleaners, etc. with power ratings of up to approx. 200 W at 12 V. Avoid damaging the socket by inserting plugs that are the wrong shape or size.

**▶** When the ignition is switched off, the power supply to all electrical sockets is switched off after approx. 1 hour. ◀

## Power socket



An additional power socket is located in the front passenger's footwell.

To gain access, fold the cover cap up.

## Ashtray, rear

### Emptying



Press the cover entirely open. The ashtray lifts up and can be removed.

## Cigarette lighter, rear



Refer to Cigarette lighter, front.

## Rear refrigerator\*

The rear refrigerator is located behind the rear seats' center armrest.

### Switching on/off



1. Switch on the ignition.
2. Press button.  
The LED in the button lights up.
3. Press the button again to switch off the rear refrigerator.

When the ignition is switched off, this also switches off the rear refrigerator.

When a low voltage is reached, it is automatically switched off to protect the vehicle battery. The LED in the button flashes.

 High temperatures in the luggage compartment can affect the temperature in the rear refrigerator. ◀

### With rear climate control

When switched on, the rear refrigerator is controlled by the rear climate control. To adjust the cooling capacity and increase the airflow volume, refer to page 108.

### Without rear climate control

When switched on, the rear refrigerator is controlled by the automatic air conditioning system. To adjust the temperature and increase the airflow volume, refer to pages 105, 106.

## Releasing



Pull on the opener and fold the refrigerator forward.

### Switching on/off via iDrive\*

iDrive, for principle details, refer to page 16.

1. Press the **MENU** button to open the start menu.
2. Move the controller toward "Climate".
3. Select "Extra" and press the controller.
4. Select "Rear refrigerator" and press the controller.



Select "Rear refrigerator" again and press the controller to switch off.

## Ski bag\*

Designed for safe, convenient transport of up to 4 pairs of standard skis or up to 2 snowboards. With the ski bag you can stow skis with a length of up to 6 ft 10 in/2.10 m. When skis of 6.9 ft/2.10 m in length are loaded, the ski bag will tend to contract, reducing its overall capacity.

## Loading

1. Fold down the center armrest in the rear backrest.
2. Pull on the handle and open the cover panel.

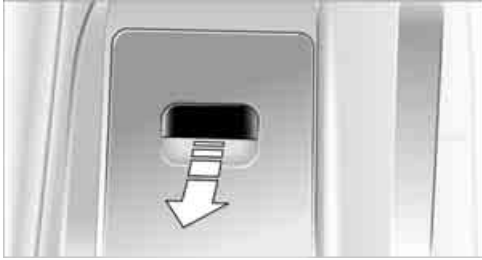

3. Remove the cover panel\* and place it on the controller in the rear.



4. To open the cover panel in the luggage compartment:  
Press the handle and slide it to the right.

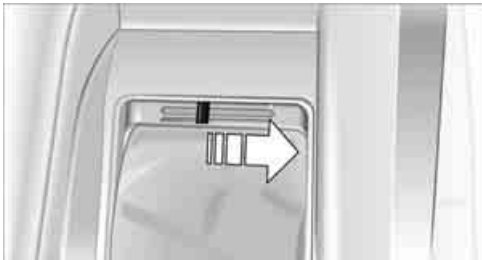

5. Place the ski bag between the front seats and load it. The zipper gives you easy access to the stowed items and facilitates drying of the ski bag.

Only place clean skis in the ski bag. Wrap sharp edges so that no damage occurs.

## Securing cargo



After loading, secure the ski bag and its contents. Tighten the retaining strap on the tensioning buckle for this purpose.

**⚠** Failure to secure the ski bag with the retaining strap could endanger occupants during braking or evasive maneuvers. ◀

## Stowing ski bag

1. To close the cover panel in the luggage compartment:  
Press the handle and slide it to the left.
2. Fold the ski bag and store it in the compartment.

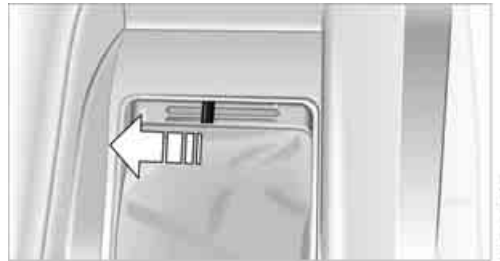

3. Snap the cover into place as shown.



4. Close the cover panel.



## Luggage compartment

### Net\*

You can use the net to stow smaller objects against the bulkhead separating the luggage compartment from the rear seats.



Do not stow objects behind the side trim panels on the left and right in the luggage compartment; otherwise, this could cause overheating and damage to the electrical parts inside. ◀



## Driving tips

This chapter is designed to provide you with extra support by supplying information useful in dealing with specific driving and operating conditions.

# Things to remember when driving

## Breaking-in

Moving parts need time to adjust to one another. To ensure that your vehicle continues to furnish optimized economy of operation throughout an extended service life, we request that you devote careful attention to the following information.

### Engine and differential

Always obey all official speed limits.

#### Up to 1,200 miles/2,000 km

Drive with changing engine and vehicle speeds, but do not exceed:

4500 rpm or 100 mph/160 km/h

Avoid full-throttle operation and use of the transmission's kick-down mode during these initial miles.

#### After 1,200 miles/2,000 km

The engine and vehicle speed can gradually be increased.

### Tires

Due to technical factors associated with their manufacture, tires do not achieve their full traction potential until after an initial break-in period. Therefore, drive reservedly during the first 200 miles/300 km.

### Brake system

Brakes require an initial break-in period of approx. 300 miles/500 km to achieve optimized contact and wear patterns between brake pads and rotors.

### Following component replacements

Follow the break-in sequence again if components addressed above must be replaced again during subsequent driving.

## General driving notes

### Closing luggage compartment lid

 Operate the vehicle only when the luggage compartment lid is completely closed. Otherwise, exhaust fumes could penetrate into the passenger compartment. ◀

If special circumstances should make it absolutely necessary to operate the vehicle with the luggage compartment lid open:

1. Close all windows and the glass sunroof.
2. Adjust the automatic climate control's blower to supply a high rate of airflow, refer to page 106.

### Hot exhaust system

 As in all vehicles, extremely high temperatures are generated in the exhaust system. Do not remove the heat shields installed adjacent to it, and never apply undercoating to them. When driving, standing at idle, and parking, take care to avoid possible contact between the hot exhaust system and any highly flammable materials such as hay, leaves, grass, etc. Such contact could lead to a fire, accompanied by the risk of serious property damage and personal injury. ◀

### Mobile communications devices in vehicle

 BMW does not recommend using mobile communications devices, e.g. mobile phones, inside the vehicle without a direct connection to an outside antenna. Otherwise, the vehicle electronics and mobile communications device can interfere with each other. In addition, there is no assurance that the radiation which results during transmission will be discharged from the vehicle interior. ◀

## Hydroplaning

 When driving on wet or slushy roads, reduce road speed. If you do not, a wedge of water can form between tires and road surface. This phenomenon is referred to as hydroplaning, and is characterized by a partial or complete loss of contact between tires and road surface, ultimately undermining your ability to steer and brake the vehicle. ◀

## Driving through water

 Only drive through water with a maximum depth of 1 ft/30 cm and then, at no more than walking speed. Otherwise, you run the risk of damaging the vehicle's engine, electrical systems, and transmission. ◀

## Safe braking

Your BMW is equipped with ABS as standard equipment. In situations that require it, it is best to apply the brakes fully. Since the vehicle maintains steering responsiveness, you can nevertheless avoid possible obstacles with a minimum of steering effort.

Pulsation at the brake pedal combines with sounds from the hydraulic circuits to indicate to the driver that ABS is in its active mode.

## Driving in wet conditions

When driving in wet conditions and in heavy rain, it is a good idea to apply light pressure to the brake pedal every few miles. Monitor traffic conditions to ensure that this maneuver does not endanger other road users. The heat generated helps dry the pads and rotors to ensure that full braking efficiency will then be available when you need it.

## Hills

 To prevent overheating and reduced efficiency of the brake system, drive long or steep downhill grades in the gear that requires the least amount of braking. Otherwise, even light but consistent pedal pressure can lead to high temperatures, brake wear, and possibly even failure of the brake system. ◀

You can further enhance the engine's braking action by selecting a lower gear in the automatic transmission's manual mode, downshifting as far as first gear on extremely steep stretches, refer to page 63. This strategy helps you avoid placing excessive loads on the brake system.

 Do not drive in idle or with the engine switched off; otherwise, there will be no engine braking action or power-assist for the brakes and steering. Never allow floor mats, carpets or any other objects to protrude into the area of movement of the pedals and impair their operation. ◀

## Corrosion on brake rotors

When the vehicle is driven only occasionally, during extended periods when the vehicle is not used at all, and in operating conditions where brake applications are less frequent, there is an increased tendency for corrosion to form on rotors, while contaminants accumulate on the brake pads. This occurs because the minimal pressure that must be exerted by the pads during brake applications to clean the rotors is not reached.

Should corrosion form on the brake rotors, the brakes will tend to respond with a pulsating effect that even extended application will fail to cure.

## When vehicle is parked

Condensation forms in the automatic climate control during operation, and then exits under the vehicle. Traces of condensed water under the vehicle are therefore normal.

## Before driving into a car wash

1. Fold in the exterior mirrors, refer to page 50; otherwise, they could be damaged due to the width of the vehicle. To permit the vehicle to roll, follow the instructions on page 58.
2. Release the parking brake, especially when you have activated Automatic Hold. Refer to page 59.

## Cargo loading

 To avoid loading the tires beyond their approved carrying capacity, never overload the vehicle. Overloading can lead to overheating of the tires and increases the rate at which damage develops inside them. The ultimate result can come in the form of a sudden blow-out. ◀

### Determining loading limit



1. Locate the following statement on your vehicle's placard\*:
  -  The combined weight of occupants and cargo should never exceed XXX lbs. or YYY kg; otherwise, the vehicle may be damaged and unstable driving conditions may result. ◀
2. Determine the combined weight of the driver and passengers that will be riding in your vehicle.
3. Subtract the combined weight of the driver and passenger from XXX lbs. or YYY kg.
4. The resulting figure equals the available amount of cargo and luggage load capacity. For example, if the XXX amount equals 1400 lbs. and there will be five 150-lb. passengers in your vehicle, the amount of available cargo and luggage load capacity is 650 lbs.:  
1400 lbs. minus 750 lbs. = 650 lbs.
5. Determine the combined weight of luggage and cargo being loaded into the vehicle. This weight may not safely exceed the available cargo and luggage load capacity calculated in step 4.

6. If your vehicle will be towing a trailer, part of the load from your trailer will be transferred to your vehicle. Consult the manual for transporting a trailer to determine how this may reduce the available cargo and luggage load capacity of the vehicle.

### Load

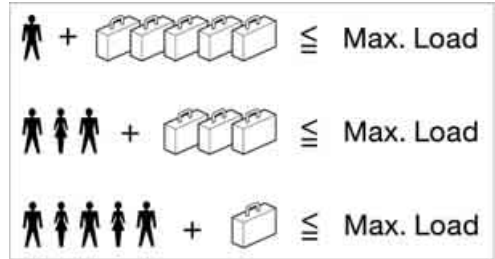

The permissible load is the total of the weight of occupants and cargo/luggage. The greater the weight of occupants, the less cargo/luggage can be transported.

### Stowing cargo

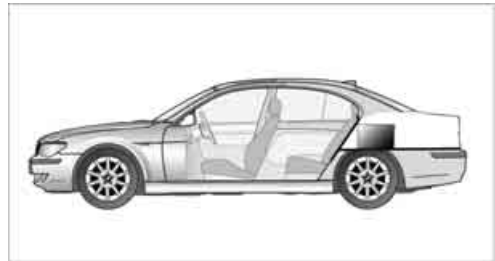

- ▷ Place heavy cargo as far forward and as low as possible, placing it directly behind the bulkhead behind the rear seats.
- ▷ Cover sharp edges and corners.
- ▷ For very heavy cargo when the rear seat is not occupied, secure each outside rear safety belt in the opposite buckle.

## Securing cargo

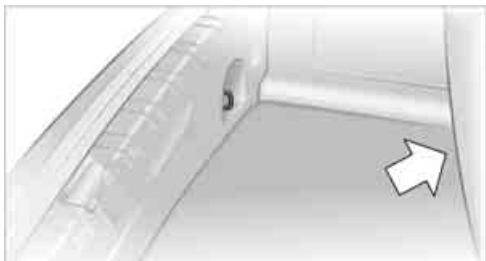

- ▶ Use the luggage net\* or securing straps to secure small and lightweight luggage and cargo.
- ▶ Heavy-duty straps\* for securing larger and heavier objects are available at your BMW center. Four lashing eyes for attaching these heavy-duty straps are provided in the luggage compartment, refer to illustration.
- ▶ Please follow the special instructions supplied with the heavy-duty straps.

 Always position and secure the load as described above. If you do not, it can endanger the passengers, for example during braking or evasive maneuvers. Attach heavy-duty straps only to the lashing eyes, refer to illustration, otherwise, the heavy-duty straps could come loose or the vehicle could be damaged. Never exceed either the approved gross vehicle weight or either of the approved axle loads, refer to page 228, as excessive loads can impair the operational safety of the vehicle and may also put you in violation of highway safety laws. You should never transport unsecured heavy or hard objects in the passenger compartment, as they could fly around and pose a safety hazard to the vehicle's occupants during abrupt braking or evasive maneuvers. ◀

## Roof-mounted luggage rack\*

A special rack system is available as an option for your BMW. Please comply with the precautions included with the installation instructions.

### Anchorage points



The anchorage points are located inside the door openings.

### Loading roof rack

Because roof racks raise the vehicle's center of gravity when loaded, they have a major effect on its handling and steering response.

You should therefore always remember not to exceed the approved roof load capacity, the approved gross vehicle weight or the axle loads when loading the rack.

You can find this information under Weights on page 228.

The roof load must be uniformly distributed and should not be too large in area. Always load the heaviest pieces on the bottom. Be sure that adequate clearance is maintained for raising the glass sunroof, and that objects do not project into the opening path of the luggage compartment lid.

Secure roof-mounted cargo correctly and securely to prevent it from shifting or falling off as you drive.

Drive smoothly. Avoid sudden acceleration and braking maneuvers. Take corners gently.

## Entry/pass tags

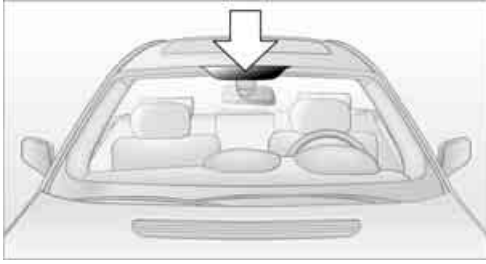

Infrared windshield technology has been used on your vehicle to minimize solar heating of the vehicle interior. This technology also reduces the ability of electronic devices to transmit and receive through the windshield, which will impair their performance and operating range.

If you want to place an electronic toll collection device or entry/pass tags behind the windshield, please use the area marked in the illustration. This area is clearly visible from inside the vehicle.









## Navigation

This section contains various examples that illustrate how the navigation system provides you with reliable guidance to your destination.

# Starting navigation system\*

Your navigation system can use satellites to ascertain the precise position of your vehicle and guide you reliably to any destination you enter.

## Navigation CD/DVD

### Installation location navigation drive

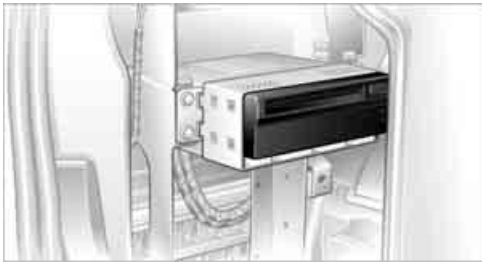

Behind the left side panel in the luggage compartment.

You can use navigation CDs, versions 2001-1 and later, and navigation DVDs in your navigation computer.

To ensure that your vehicle's navigation system has access to the latest highway system information, always load the most recent CD/DVD version of the digital road map.

As is the case with conventional road maps, the navigation CDs/DVDs are subject to periodic updates to ensure that they reflect the latest information and surveys.

 Navigation CDs/DVDs are available at your BMW center. ◀

### Inserting navigation CDs/DVDs

Navigation CDs/DVDs are to be inserted into the navigation player.

1. Insert the navigation CD/DVD with the labeled side up.
2. Wait a few seconds until the CD/DVD contents are read.

### Removing navigation CD/DVD

1. Press the  button.
2. Remove navigation CD/DVD.

## Display in assistance window\*

You can also view the route guidance in the assistance window; it then remains visible when you select a new menu.

iDrive, for principle details, refer to page 16.

1. Press the **MENU** button to open the start menu.
2. Move the controller toward "Navigation".
3. Press the controller as needed.
4. Select "Split" and press the controller.

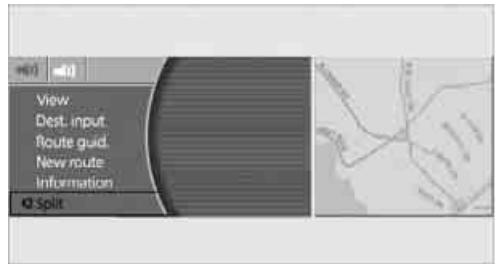

The route is shown in various views in the assistance window during route guidance, refer to Displaying route, page 145:

- ▷ North orientation
- ▷ Direction of travel
- ▷ Perspective
- ▷ Arrow display

# Destination input

When entering your destination, you can select from among the following options:

- ▷ Entering destination manually, see below.
- ▷ Selecting destination using a map, refer to page 135.
- ▷ Selecting destination using information, refer to page 135.
- ▷ Selecting from among recent destinations, refer to page 137.
- ▷ Selecting destination from address book, refer to page 139.
- ▷ Selecting home address, refer to page 141.

After selecting your destination you can proceed to start the route guidance, refer to page 144.

 Enter data only when the vehicle is stationary, and always give priority to the applicable traffic regulations in the event of any contradiction between traffic and road conditions and the instructions issued by the navigation system. If you do not comply with this precaution, you can endanger vehicle occupants and other road users. ◀

iDrive, for principle details, refer to page 16.

1. Press the **MENU** button to open the start menu.
2. Move the controller toward "Navigation".

## Entering destination manually

The system relies on a wordmatch principle to make it easier for you to enter the names of towns or streets. It supports various spellings as well as automatic name completion, refer to page 142.

1. Select "Dest. input" and press the controller.

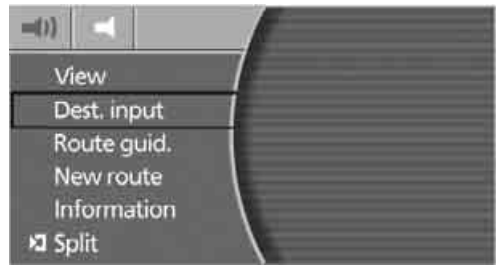

2. Select "New dest." and press the controller.



3. Select "ABC..." and press the controller.

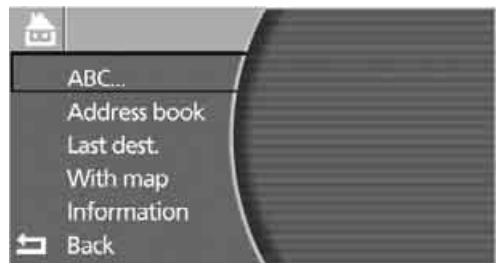

The system also assists you with the following features:

- ▷ If you do not enter a street, the system will guide you to the downtown area of a town or city.
- ▷ Depending on the data stored on your navigation CD/DVD, you can also enter the house or building number on some streets.



- ▷ You can skip the entry of country and city if the existing entries should be retained for your new destination.

Using the voice command system:

1. ›Navigation‹.
2. ›Destination input‹.

## Entering name

You do not absolutely have to enter a name to use route guidance or to store an address in the list, but assigning each address a name can make it easier for you to recognize the addresses in a list.

1. Select "Name" and press the controller.
2. Turn to select the letters, then confirm your selections by pressing.
  - ▷ To enter a blank space: Select the  symbol and press the controller.
  - ▷ To delete the last letter entered: Select the  symbol and press the controller.
  - ▷ To cancel selection: Select the  arrow and press the controller.

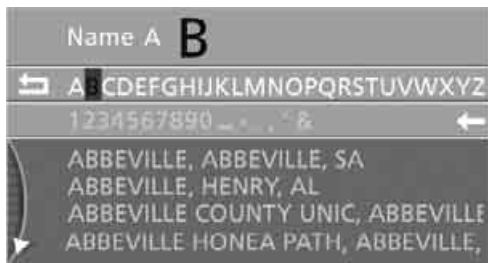

3. Select the name shown in the lower half of the Control Display and press the controller.

## Selecting country

When the name of a country appears in white letters on the Control Display, this indicates that data for more than one country is stored on the navigation CD/DVD.

1. Select "State / Province" or the country displayed and press the controller.

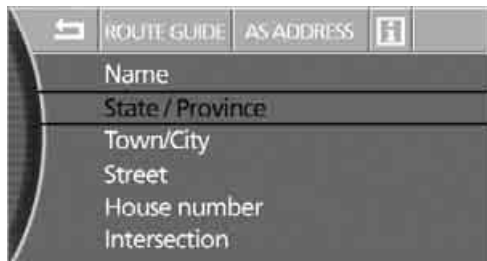

A list of available countries appears on the display.

2. Select country of destination of state and press the controller.



In order to be able to start the route guidance, you must at least enter the town/city of destination.

## Entering town/city of destination via town/city name

1. Select "Town/City" or the town/city displayed and press the controller.
2. Select the first letters and press the controller.

A list of all towns/cities starting with this letter appears on the Control Display.

3. Enter additional letters if necessary. The list gradually grows smaller each time you enter a new letter.

- ▷ To enter a blank space: Select the  symbol and press the controller.
- ▷ To delete the last letter entered: Select the  symbol and press the controller.

- ▷ To cancel selection:  
Select the ↩ arrow and press the controller.



4. Turn the controller to select place names in the list and press the controller.

### Entering town/city of destination with zip code\*

You can enter the zip code if the navigation CD/DVD supports this function.

1. Select "City / Postal Code" and press the controller.
2. Enter the zip code:  
Select numbers individually and press the controller each time.
  - ▷ To enter a blank space:  
Select the **□** symbol and press the controller.
  - ▷ To delete last digit or letter:  
Select the ← symbol and press the controller.
  - ▷ To cancel selection:  
Select the ↩ arrow and press the controller.
3. Select the zip code and press the controller. The corresponding town/city of destination is displayed.
4. Turn the controller to select place names in the list and press the controller.

## Entering street, house number, and intersection

### Entering street

1. Select "Street" or the street displayed and press the controller.
2. Enter in the same way as described under Entering town/city of destination via town/city name.

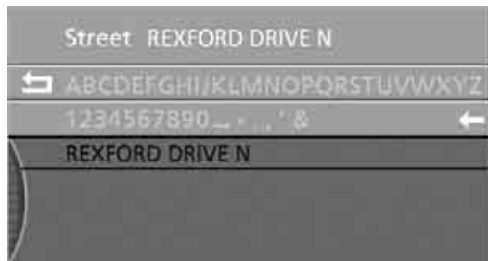

### Entering a street without entering town/city of destination

You can also enter a street without entering a town/city of destination if the navigation CD/DVD supports this function. In this case, all streets of the entered country are offered for selection. The related town/city is displayed after the street name.

If a town/city has already been entered, you can cancel this entry. This may be practical if the desired street does not exist in the entered town/city of destination, because, for example, it belongs to another part of the town/city.

1. Turn the controller until the top field is selected.



2. Press the controller.

3. Enter the street.  
You can change to the entered town or city in the same way again to enter a street.

## Entering intersection

The intersection is entered in the same way as the street.

## Entering house number

You can enter the house number if the navigation CD/DVD supports this function.

1. Select "House number" and press the controller.
2. Enter the house number:  
Select numbers individually and press the controller each time.
  - ▶ To delete last digit or letter:  
Select the ← symbol and press the controller.
  - ▶ To cancel selection:  
Select the ↩ arrow and press the controller.

If the house number entered is not stored on the navigation CD/DVD, then the system displays the closest possible number.

3. Select "Enter" and press the controller.

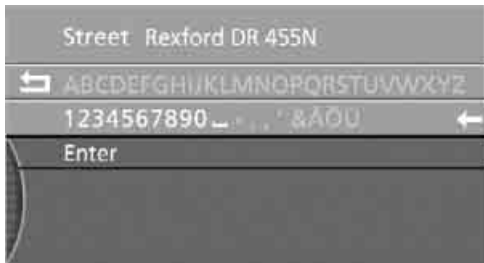

## Starting route guidance with manual destination input

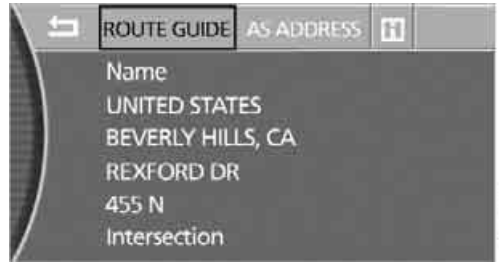

Select "ROUTE GUIDE" and press the controller.

Route guidance starts immediately.

If the route guidance cannot be started, at least one entry must be deleted from the destination list, refer to page 138.

▶ If you do not wish to start route guidance immediately, you can store the address in the address book, refer to page 139, and import it into the route guidance later. ◀

## Displaying information about destination

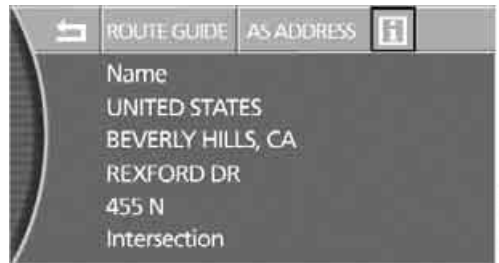

Select the **i** symbol and press the controller.

Additional instructions about the information, refer to page 135.



## Map-guided destination selection

If you only know the street or location of the town/city of destination, then you can enter the destination using a map. You can select the destination on the map using crosshairs and then adopt it into the route guidance:

1. Select "Dest. input" and press the controller.
2. Select "New dest." and press the controller.



3. Select "With map" and press the controller.

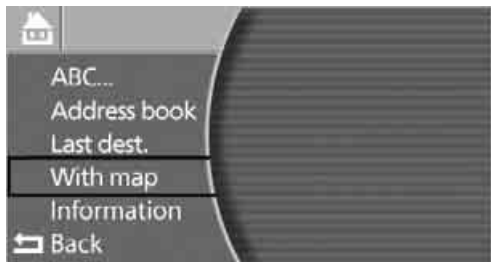

A section of a map appears on the Control Display:

- ▷ During route guidance, the map is centered around the current destination
  - ▷ With the route guidance deactivated, the map is centered around the last destination entered
4. Select the destination with crosshairs.
    - ▷ Changing scale: turn controller
    - ▷ Moving map: move the controller in the corresponding direction.

The street name or town name of the point in the crosshairs is displayed as soon as the map stops moving.

5. Press the controller to view other menu items:
  - ▷ "Next" changes back to "With map".
  - ▷ "Location" selects the current position as the center point of the map.
  - ▷ "Destin." selects the active destination or the last town/city of destination as the center point of the map.
  - ▷ "Save dest." imports the address marked by the cursor into the destination input.



If the navigation system is unable to identify a street or town/city, your current map coordinates will appear. A street name in the vicinity of the selected destination will be displayed.

In order to be able to select this position as a destination or to store it in the address book as an address, a name must first be entered, refer to page 132.

## Selecting destination via information

You can display selected destinations, e.g. hotels, points of interest, or hospitals, and adopt them into the route guidance.

"General destination" and "Travel information" are essentially the same; the difference is that "Travel information" offers a greater selection of possible destinations.

### General destination

1. Select "Dest. input" and press the controller.
2. Select "New dest." and press the controller.

3. Select "Information" and press the controller.
4. Select "General destination" and press the controller.

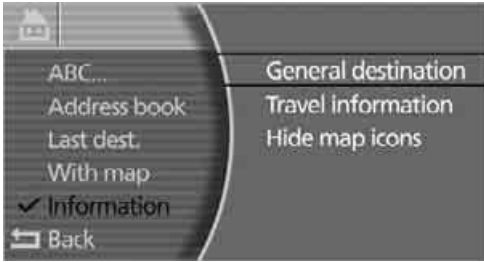

5. Select "On location" and press the controller.

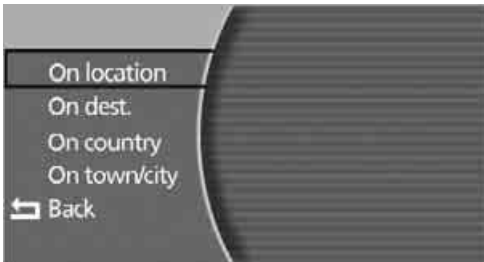

6. Select from the individual categories of information, e.g. select "Public places, business and shopping" and press the controller.

▶ When selecting information "On dest.", "On country" and "On town/city", enter destination, country, and town/city as needed. If destinations have already been entered, information about the destination is displayed at the top of the destination list. ◀

7. Make a different selection, e.g. industrial centers.

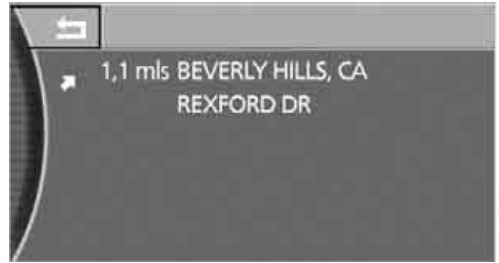

The destinations are displayed on the Control Display, sorted by distance, and are provided with orientation arrows that point toward the destination.

▶ When selecting information "On dest.", "On country", and "On town/city", the destinations are displayed sorted alphabetically. ◀

8. Select the destination and press the controller.

Using the voice command system:

1. ›Navigation‹
2. ›Information location‹
3. Enter the desired destination category:
  - ▶ ›Hotels‹
  - ▶ ›Parking‹
  - ▶ ›Gas stations‹

## Travel information

1. Select "Dest. input" and press the controller.
2. Select "New dest." and press the controller.
3. Select "Information" and press the controller.
4. Select "Travel information" and press the controller.

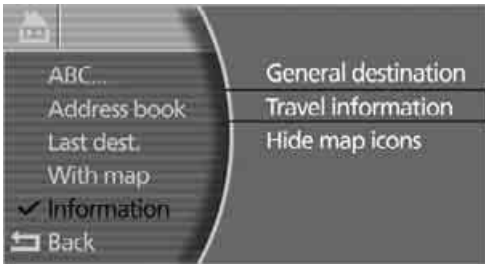

Different categories are shown depending on the map DVD, e.g. hotels and restaurants.

5. Select the desired category and press the controller.



6. Limit the selection with additional information, e.g. enter the maximum distance to the desired destination or the name of the destination. In addition, optional entries can be made, e.g. displaying BMW partner hotels. The destinations in the surrounding area are displayed, sorted by distance to the destination and the other information.
7. Select the destination and press the controller.

To exit the menu:

Select the  arrow and press the controller.

### Hiding icons in the map view

In the map view, the destinations of the selected category are displayed in the form of icons as a function of the map scale and category. You can hide them.

Select "Hide map icons" and press the controller.

To display the icons, select a category again under "General destination" or "Travel information".

## Recent destinations

The system stores the last ten destinations entered. You can import these destinations into the route guidance and edit the entries and the list.

### Importing destination into route guidance

1. Select "Dest. input" and press the controller.
2. Select "New dest." and press the controller.
3. Select "Last dest." and press the controller.

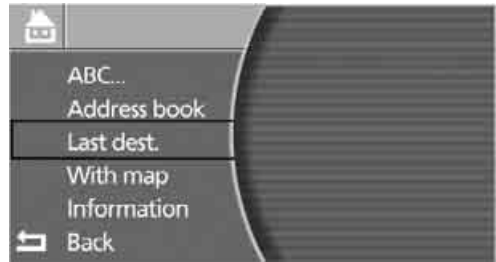

A list of the destinations last reached appears on the right side of the Control Display.

4. Select the desired destination and press the controller.
5. "ROUTE GUIDE" is selected. Press the controller. Route guidance starts.

### Editing recent destinations

You can edit the last destinations in the same way as the destination list, refer to Editing destination list on page 138.

## Destination list

The destination list includes the last 25 destinations entered. The most recently entered destination appears at the top of the list.

The system guides you to the destinations in the sequence in which they appear in the destination list. You are thus guided first to the destination in the top or first position of the destination list.

You can edit individual destinations and their sequence in the list and delete the destination list, refer to Editing destination list on page 138. In order, for example, to plan a longer route, you can store all of the destinations to which you wish to drive in the destination list, refer to Entering destination manually on page 131.

 If the destination list is full, then you must delete at least one entry in order to be able to store a new destination in the destination list. ◀

1. Select "Dest. input" and press the controller.
2. Select "Dest. list" and press the controller.





## Importing destination into route guidance

1. Select desired destination from destination list and move to top or first position of destination list, refer to Editing destination list.
2. Select "Route guid." and press the controller. Route guidance starts.

Using the voice command system:

 ›Route guidance on‹ .

## Editing destination list

1. Select the desired destination in the destination list and press the controller.
2. The selected destination can be edited:
  - ▷ Change entry:  
Select "CHANGE" and press the controller.
  - ▷ Delete entry:  
Select "DELETE" and press the controller.
  - ▷ Move the address up or down in the destination list:  
Select the   symbols and press the controller. This changes the order of the destination list.
  - ▷ Change back to "Dest. list":  
Select the  arrow and press the controller.

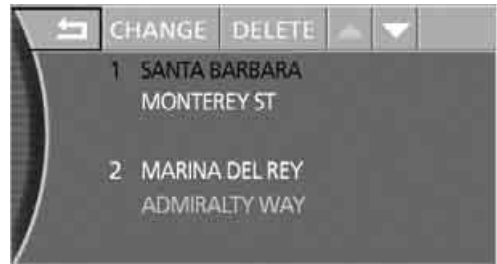

## Deleting destination list

1. Select the  symbol and press the controller to delete all existing entries.



2. Select "YES" and press the controller to delete the destination list.

## Address book

You can store destinations in the address book and adopt them directly into the route guidance.

You can store the addresses in two separate address books:

- ▶ the address book of the navigation system
- ▶ the address book of the voice command system

### Navigation system address book

The entries in the address book are sorted alphabetically.

1. Select "Dest. input" and press the controller.
2. Select "New dest." and press the controller.
3. Select "Address book" and press the controller.  
A list of the stored addresses appears on the right side of the Control Display.

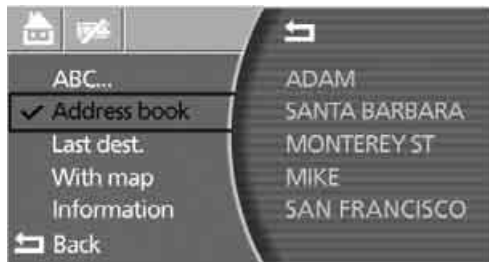

### Storing destinations in address book

You can enter the addresses manually or import the most recent destinations. You can store approx. 100 addresses in the address book.

1. Enter the desired destination manually or select from the destination list:
  - ▶ Entering destination manually:  
Refer to page 131.
  - ▶ Selecting destination from among recent destinations:  
Refer to page 137.
  - ▶ Selecting destination from destination list:  
Refer to page 138.

2. Enter name and address if necessary, refer to page 132.
3. Select "AS ADDRESS" and press the controller.

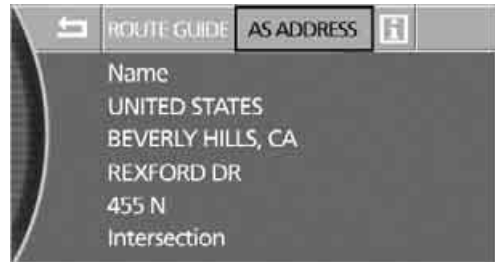

The entry is stored in the address book.

### Storing current position

The current position can be imported into the address book.

1. Select "Dest. input" and press the controller.
2. Select "Location" and press the controller.  
The current position can be provided with a name and any specified name can be changed, refer to page 132.
3. Select "AS ADDRESS" and press the controller.

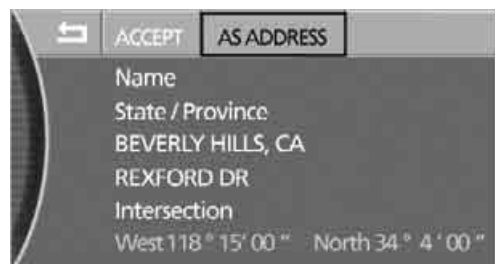

The current address is stored in the address book.

You can also import your current position into the address book if you have left the sector covered by the navigation DVD. In this case, you must enter a name.

## Selecting destinations from address book

1. Select "Address book" and press the controller.  
A list of the stored addresses appears on the right side of the Control Display.
2. Select the address and press the controller.
3. To start the route guidance:  
Select "ROUTE GUIDE" and press the controller.

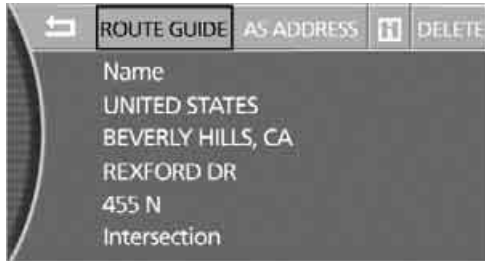

## Changing destinations in address book

1. Select "Address book" and press the controller.  
A list of the stored addresses appears on the right side of the Control Display.
2. Select the address and press the controller.  
Change entry, refer to Entering destination manually, page 131.

 When an entry is changed, a copy of the entry is stored. ◀

## Deleting destinations individually from address book

1. Select "Address book" and press the controller.  
A list of the stored addresses appears on the right side of the Control Display.
2. Select the address and press the controller.
3. Select "DELETE" and press the controller.
4. Select "YES" and press the controller to delete the address.

## Deleting all destinations from address book

1. Select "Address book" and press the controller.

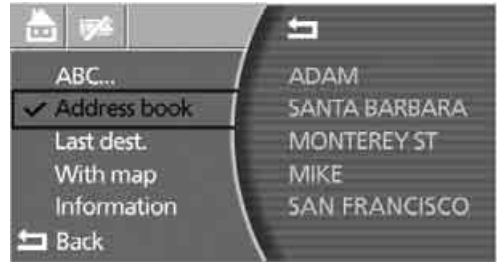

A list of the stored addresses appears on the right side of the Control Display.

2. Select the  symbol and press the controller to delete all existing entries.
3. Select "YES" and press the controller to delete the address book.

## Home address

### Storing home address

You can store your current position or the current destination as the home address in the address book.

1. Select the  symbol and press the controller.
2. To store the current position as your home address:
  - ▷ Select "LOC." and press the controller.



To store a destination already current as your home address in the address book:

- ▷ Select "ACCEPT" and press the controller.

The entered address or current position is applied as your home address.

Entering or editing your home address occurs in the same way as entering a destination, page 131.

To exit the menu:

Select the  arrow and press the controller.

## Selecting home address

You can import your home address stored in the address book into the route guidance system.

1. Select the  symbol and press the controller.
2. Select "ROUTE GUIDE" and press the controller.

Route guidance starts.

To exit the menu:

Select the  arrow and press the controller.

Using the voice command system:

1. ›Navigation⟨.
2. ›Home⟨.

## Voice command system address book

 The house number is not stored in the address book of the voice command system. ◀

## Storing destinations in address book

The first entry of the destination list can be stored. To save other addresses, change the destination list accordingly, refer to page 138.

Using the voice command system:

1. ›Navigation⟨.
2. ›Save destination⟨.
3. Say the name that is associated with the destination coordinates.

## Selecting destinations from address book

1. ›Navigation⟨.
  2. ›Select destination⟨.
  3. Say the name.
- or
1. ›Navigation⟨.
  2. ›Read out⟨.
    - ▶ To scroll forward: ›Next⟨.
    - ▶ To scroll back: ›Back⟨.
    - ▶ To repeat: ›Repeat⟨.
    - ▶ To apply in destination list: ›Select⟨.

## Deleting destinations from address book

To delete individual destinations:

1. ›Navigation⟨.
2. ›Delete⟨.
3. Say the name.

To delete all existing entries:

1. ›Navigation⟨.
2. ›Delete address book⟨.

## Route selection

You can influence the calculated route by choosing certain route criteria.

The route is planned according to fixed rules, taking the road type into account, e.g. whether the route involves highways or winding roads. The road types are stored on the navigation DVD. As a result, the routes recommended by the navigation system may not always be the same ones that you would choose based on personal experience.

## Changing route criteria

1. Select "New route" and press the controller.
2. Select "Route preference" and press the controller.

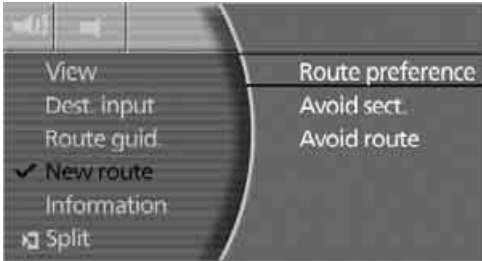

The various criteria are listed on the Control Display.

3. Select one of the four route criteria of the route and press the controller.

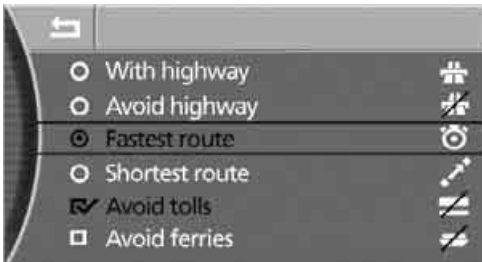

- ▷ "With highway"  
Highways and major traffic arteries receive top priority.
- ▷ "Avoid highway"  
Highways are avoided where possible.
- ▷ "Fastest route"  
Takes the shortest amount of time by combining the shortest possible distance and the fastest roads.
- ▷ "Shortest route"  
Takes the shortest distance, without taking time into consideration.
- ⊙ The route criterion is selected.

4. Choose additional route criteria if need be and press the controller:
    - ▷ "Avoid tolls"  
Tollroads are avoided where possible.
    - ▷ "Avoid ferries"  
Ferries are avoided where possible.
    - ☑ The supplemental criterion is selected.
- To exit the menu:  
Select the ↩ arrow and press the controller.

You can change the route selection as often as you like while entering a destination or during route guidance.

Using the voice command system:

1. ›Navigation‹.
2. ›Route selection‹.
3. Enter the desired priority for your travel route:
  - ▷ ›Via freeway‹.
  - ▷ ›Without freeway‹.
  - ▷ ›Fastest‹.
  - ▷ ›Shortest‹.

## Wordmatch principle

The system relies on a wordmatch principle to make it easier for you to enter the names of towns or streets. The system runs ongoing checks, comparing your destination entries with the data stored on the navigation DVD as the basis for instant response. The user benefits include:

- ▷ Names of specific locations can also vary from the official versions, provided that the spelling of the entry corresponds to a standard form used in another country.
- ▷ When you are entering the names of cities and streets, the system will complete them automatically as soon as enough letters are available to ensure unambiguous identification.

Example:

If you want to drive to Iowa Ave NW in Washington, D.C., by the time "o" is



entered, the system has already identified the street name and displayed it in the lower half of the Control Display.

- ▷ The system only gives you the option of entering letters for names that are stored on the navigation DVD. It is therefore impossible to enter incorrect names or to enter address data that are not included on the DVD.

# Route guidance

## Starting route guidance

The route guidance is started for the first destination in the destination list, refer to page 138. There must be at least one destination in the destination list.

iDrive, for principle details, refer to page 16.

1. Press the **MENU** button to open the start menu.
2. Move the controller toward "Navigation".
3. Press the controller as needed.
4. Select "Route guid." and press the controller.

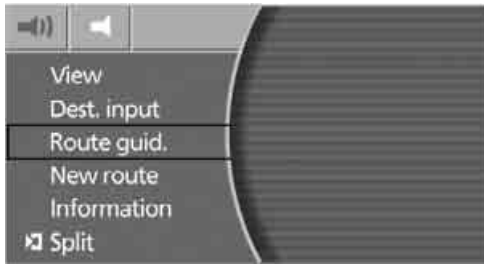

Route guidance starts. As the navigation computer determines the route to your destination, the distance and the true compass direction to your destination will appear on the upper right of the Control Display – not in all display modes.

After calculation of the route, the selected view of route guidance appears on the display. The town/city of destination is displayed on the status line.

During route guidance, you can operate other equipment via iDrive at any time. You are notified well in advance of a necessary change of direction by voice instructions.

Using the voice command system:

- 1. ›Route guidance on‹.

## Terminating/continuing route guidance

### Terminating route guidance

1. Press the controller as needed.
2. Select "Route guid." and press the controller.

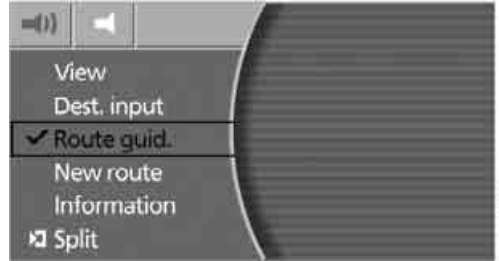

Route guidance is switched off.

Using the voice command system:

- 1. ›Navigation‹.
- 2. ›Route guidance off‹.

### Continuing route guidance

If the destination was not reached before the end of the last trip or it was reached and there is still another destination on the destination list, the following question will be displayed at the beginning of the next trip when navigation is activated: "Continue route guidance?".

To start the route guidance immediately: Select "YES" and press the controller.

## Displaying route

You have the option of displaying various views of the route during route guidance.

### Selecting arrow display

1. Press the controller as needed.
2. Select "View" and press the controller.
3. Select "Arrow display" and press the controller.

The route guidance is displayed by means of arrows on the Control Display and on the Info Display, refer to page 12.



- 1 Arrow to destination, as the crow flies
- 2 Distance to destination on the calculated route
- 3 Destination
- 4 Street name of next change of direction
- 5 Distance to next change of direction
- 6 Current position
- 7 Direction of travel

The arrows are shown in different sizes and forms depending on the distance to the next change of direction.

 In areas for which your navigation DVD does not yet provide comprehensive coverage, a directional arrow follows the course of the route. This feature is intended to assist you at crossroads and intersections. ◀

Using the voice command system:

1. ›Navigation◁.
2. ›Arrow◁.

### Selecting map view

You can have your current position displayed on a map. After starting the route guidance, the planned route is shown on the map.

1. Press the controller as needed.
2. Select "View" and press the controller.
3. Select the desired map view and press the controller.

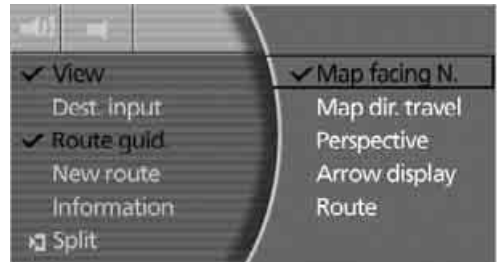

- ▷ "Map facing N."
- ▷ "Map dir. travel"
- ▷ "Perspective"

Using the voice command system:

1. ›Map◁  
Shows the currently selected map view of the navigation system.

### Changing scale

Turn the controller to adjust the scale.

Scales on the navigation CD:  
400 ft/100 m to 50 miles/100 km

Scales on the navigation DVD:  
400 ft/100 m to 500 miles/1000 km

Using the voice command system:

1. ›Scale◁.
2. Enter the desired map scale.

## Displaying streets or towns on the route

You can have the names of the streets and towns/cities on your route displayed whenever the route guidance is active.

The display also shows the distances to be traveled on each individual road.

1. Press the controller as needed.
2. Select "View" and press the controller.
3. Select "Route" and press the controller.



To exit the menu:

Select the  arrow and press the controller.

## Route guidance by voice instructions

### Switching voice instructions on/off

1. During route guidance, press the controller.
2. Select the  symbol and press the controller.

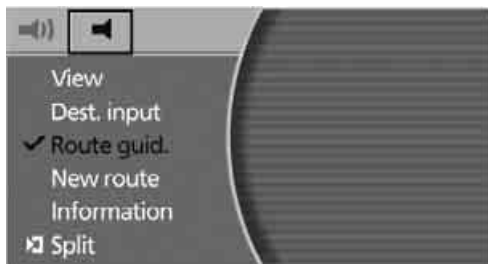

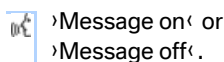

The setting is stored for the remote control currently in use.

Using the voice command system:



## Repeating voice instructions

1. During route guidance, press the controller.
2. Select the  symbol and confirm your selection to repeat the last route instruction when the voice output is switched on.

 It is also possible to request a repetition of the spoken instructions via the programmable buttons on the steering wheel and next to the controller, refer to page 52. ◀

## Adjusting volume

The volume can only be adjusted during a voice instruction.

1. Repeat the last voice instruction if necessary.
2. Wait until the voice instruction is being issued, then turn the knob to select the desired volume.



This volume is independent of the volume selected for the audio and video sources.

The setting is stored for the remote control currently in use.

## Changing route

### Avoiding route sections

From a list, you can select and bypass certain sections that you do not wish to travel on the planned route. The route is recalculated.

1. Press the controller.
2. Select "New route" and press the controller.

3. Select "Avoid sect." and press the controller.

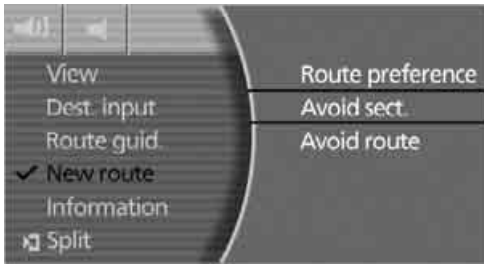

The route list appears on the Control Display.

4. Select one or more route sections to be avoided and press the controller.  
To correct an incorrect entry:  
Select another route section and press the controller.
5. To exit the route list and calculate a new route:  
Select the arrow and press the controller.

### Bypassing route sections

During route guidance, you can revise the navigation system's route recommendations to bypass particular stretches of road. Enter the number of miles/kilometers that you want to travel before returning to the original route. You can bypass a particular distance of up to 32 miles/50 km.

1. Press the controller.
2. Select "New route" and press the controller.
3. Select "Avoid route" and press the controller.

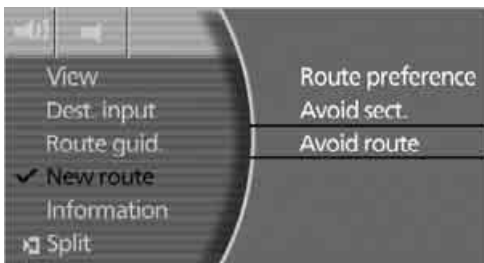

4. Turn the controller to input the desired number and press the controller.
5. Select "Calculate" and press the controller.  
The route is recalculated.

To leave the route without changing it:  
Select the arrow and press the controller.

## Displaying current position

You can have your current position displayed even when the route guidance is switched off.

### Storing current position

1. Select "Dest. input" and press the controller.
2. Select "Location" and press the controller.



The current position of your BMW is displayed.

3. Select "AS ADDRESS" and press the controller.

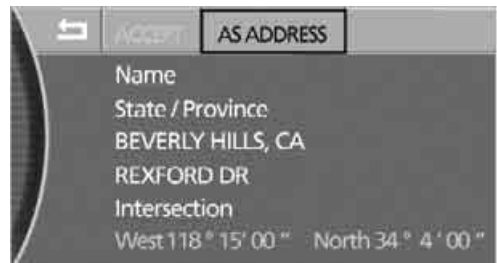

To exit the menu:  
Select the arrow and press the controller.

## Correcting current position

If the navigation system cannot place the current position, e.g. if you are currently in a parking structure, then in addition to the country and city, only longitude and latitude are displayed. You can then correct your current position, e.g. by entering the name of the adjacent street or intersection.

1. Select "Dest. input" and press the controller.
2. Select "Location" and press the controller.

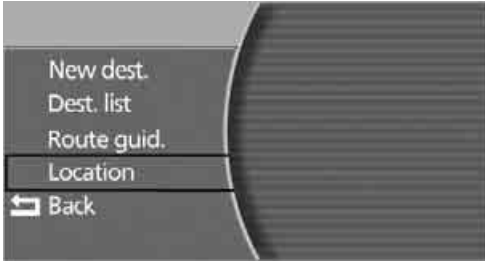

3. Select "Street" or "Intersection" and press the controller.  
A list of possible street names is displayed.
4. Select the desired street and press the controller.
5. Select "ACCEPT" and press the controller.



6. Select "AS ADDRESS" as needed and press the controller to import the position into the address book.

To exit the menu:

Select the  arrow and press the controller.

You can also have the current position displayed on a map, refer to Selecting map view on page 145.

# What to do if ...

## What to do if ...

- ▶ a navigation DVD is inserted, but an instruction to insert the DVD appears on the Control Display?  
The navigation DVD may not be the right DVD for the navigation system. The DVD is labeled accordingly.
- ▶ you request the current position of your vehicle, but do not receive a precise display?  
The system is unable to receive enough GPS signals at your current position due to obstructions, your position is not yet available on your navigation DVD, or the system is in the process of calculating your position. Please wait and then try again a little later.
- ▶ the route guidance does not accept a destination?  
The data of the destination is not stored on the navigation DVD that is loaded. Select a destination that is as close as possible to the original.
- ▶ the route guidance does not accept a destination without the street?  
On the navigation DVD, no downtown area can be determined for the city or town entered. Enter any street, or a destination such as the railway station etc., then start the route guidance.
- ▶ you want to enter a destination for the route guidance, but it is not possible to select the letters for your desired entry?  
The data of the destination is not stored on the navigation DVD that is loaded. In this case, the system will not offer you any letters to choose from. Select a destination that is as close as possible to the original.

- ▶ the system stops furnishing directions on which way to turn as you approach intersections?  
You are driving in an area that has not yet been completely recorded on the navigation DVD. Instead of an arrow indicating a turn, you will see an arrow which indicates the general direction of your planned route. Or you have left the recommended route and the system requires a few seconds to calculate a new recommended route.
- ▶ the navigation system does not react to entries?  
If the battery was disconnected, it then takes up to 10 minutes before the system is once again operational.







## Entertainment



The chapter ensures your enjoyment when receiving radio stations or playing CDs or DVDs.

# On/off and settings

The following audio and video sources share the same controls and adjustment options.

- ▷ Radio
- ▷ CD player\*
- ▷ CD changer\*
- ▷ DVD changer\*

 The CD changer can play CDs with compressed audio files, such as MP3s. ◀

- 4 CD slot
- 5  button  
Eject CD
- 6  button  
Station scan/track search
  - ▷ Select radio station
  - ▷ Fast forward/reverse
  - ▷ Change track for CD player, change chapter for DVD changer



## Controls

The audio and video sources can be operated using:

- ▷ Buttons on the CD player
- ▷ iDrive
- ▷ Buttons on steering wheel, refer to page 11

## Buttons on the CD player



- 1 Entertainment sound output on/off, volume
  - ▷ Press: switching on/off  
When switching on, the most recently selected radio station or CD track is selected.
  - ▷ Turn: adjusting volume
- 2  button  
Selecting radio, CD player, and CD changer
- 3  button
  - ▷ Press briefly: selecting AM or FM wave-band
  - ▷ Press and hold: Autostore, updating selection of stations in range

## Operating via iDrive

iDrive, for principle details, refer to page 16.

1. Press the **MENU** button to open the start menu.
2. Move the controller toward "Entertainment".

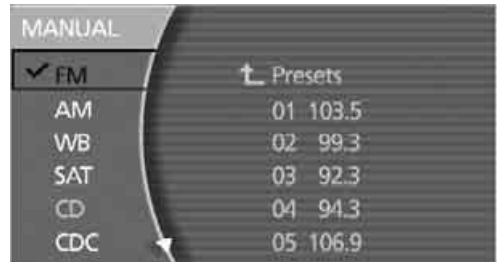

3. You have the choice of:
  - ▷ "FM" and "AM": select radio reception.
  - ▷ "WB": select Weather Band.
  - ▷ "SAT": select satellite radio.
  - ▷ "CD" and "CDC": select CD player or CD changer.
  - ▷ "AUX": select external audio device
  - ▷ "DVD": select DVD changer\*.
  - ▷ "Picture": adjust picture\*.
  - ▷ "Tone": tone control, e.g. treble and bass.

You can also control the radio, CD player, CD changer, external audio devices, and the DVD changer using the buttons on the steering

wheel, refer to page 11, and via the voice command system\*, refer to page 23.

## Switching on/off



In order to switch the Entertainment sound output on/off: press the knob.

The system selects the most recently used audio or video source, radio, CD, external audio device, or DVD.

Using the voice command system:

 ›Radio‹ or ›Audio off‹.

## Using with ignition off

The audio and video functions remain available for use for a period of approx. 30 minutes after you switch off the ignition.

Switch the sound output back on to enjoy this function.

## Adjusting volume



Turn the knob to the desired volume level.

 The sound system automatically reverts to its mute mode whenever you initiate or accept a phone call. ◀

The setting is stored for the remote control currently in use.

## Tone control

You can change various tone settings, e.g. treble and bass or the speed-dependent volume control. The tone settings are set globally for all of the audio sources.

Speakers, headsets in the rear, and external audio devices can be adjusted separately. The sound settings of the headphones are made on the rear seat screen with the headphones connected. Only treble, bass and balance can be adjusted.

The setting is stored for the remote control currently in use.

## Tone adjustment

iDrive, for principle details, refer to page 16.

1. Press the **MENU** button to open the start menu.
2. Move the controller toward "Entertainment".
3. Select "Tone" and press the controller.



4. Select desired tone settings.

## Treble and bass

1. Select "Treble" or "Bass" and press the controller.

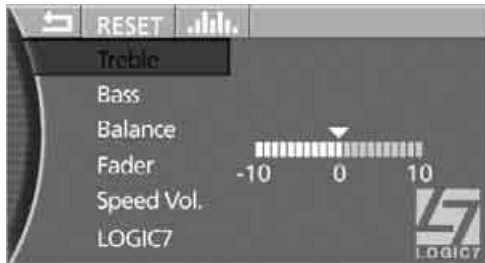

2. Turn the controller until you reach the desired setting.
3. Press the controller to save the setting.

## Balance and fader

1. Select "Balance" or "Fader" and press the controller.

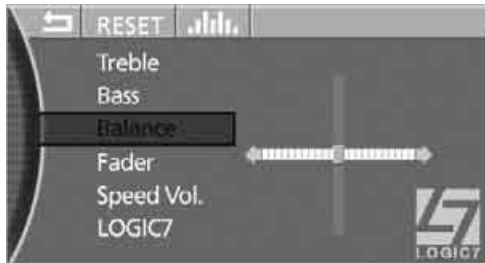

2. Turn the controller until you reach the desired setting.
3. Press the controller to save the setting.

## Speed-dependent volume control

The speed-dependent volume control automatically increases the volume as the speed increases. You can set various stages for the volume increase.

1. Select "Speed Vol." and press the controller.
2. Turn the controller until you reach the desired setting.
3. Press the controller to save the setting.

## LOGIC7\*

sets the spatial sound effect between the values 0 and 10. The best possible spatial sound lies at the values 5 and 6. At 0, the spatial sound effect is switched off. This setting is suitable for radio plays, for example.

1. Select "LOGIC7" and press the controller.



2. Turn the controller until you reach the desired setting.
3. Press the controller to save the setting.

 LOGIC7 and the LOGIC7 logo are registered trade marks of Lexicon, Inc., a company of the Harman International Group. ◀

## Equalizer

You can adjust individual audio frequency ranges.

1. Select the  symbol and press the controller.
2. Turn the controller to the left or right to select the desired frequency range and then press the controller.

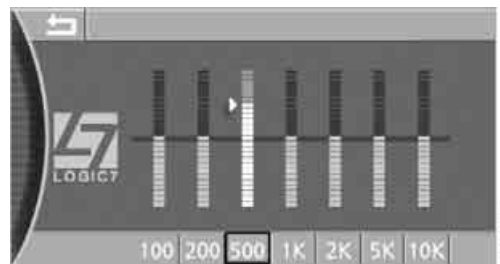

3. Turn the controller until you reach the desired setting.
4. Press the controller to save the setting.

## Resetting tone settings

You can reset all tone settings except "Speed Vol." to the standard default settings.

Select "RESET" and press the controller.

# Radio

Your radio is equipped to receive the FM and AM wavebands.

## Listening to radio

Switch on audio or video sources, refer to page 153.

iDrive, for principle details, refer to page 16.

1. Press the **MENU** button to open the start menu.
2. Move the controller toward "Entertainment".
3. Select "FM" or "AM" and press the controller.

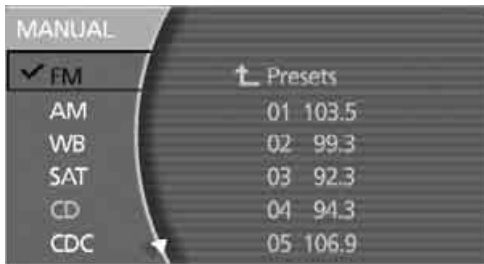

Stations are shown on the Control Display on the basis of various selection criteria, e.g. "Presets".

Using the voice command system:

1. ›Radio‹.
2. ›FM‹ or ›AM‹.

## Changing station

### Using buttons in center console

Press the ◀ ▶ button for the corresponding direction until you reach the next station.

Using the voice command system:

1. ›Radio‹.
2. ›Next station‹ or ›Station back‹.

## Using iDrive

FM waveband:

1. Select "FM" and press the controller.

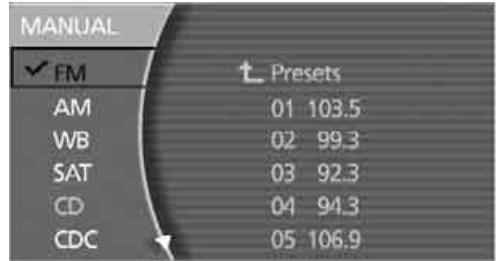

2. Choose the selection criterion and press the controller.
  - ▷ "Autostore list": Selection of "FM" stations within reception range during the last autostoring procedure, refer to page 158.
  - ▷ "Presets": Display of up to twelve stations that you have previously stored, refer to page 158.
3. Turn the controller to select a station and press the controller.

AM waveband

1. Select "AM" and press the controller.
2. Choose the selection criterion and press the controller.
  - ▷ "Presets": Display of up to twelve stations that you have previously stored, refer to page 158.
  - ▷ "Autostore list": Selection of stations in the "AM" waveband within reception range during the last autostoring procedure.



3. Turn the controller to select a station and press the controller.

### Sampling stations, scan

The system automatically plays a brief sample from each of the stations on the current waveband.

1. Select "FM" or "AM" and press the controller.

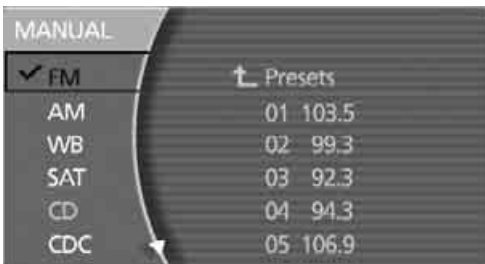

2. Select "MANUAL" and press the controller.



3. Select "SCAN" and press the controller.



Scan starts.

To end scan:

Select "SCAN" and press the controller. Scan is interrupted and the currently selected station is played.

### Selecting frequency manually

You can use the manual search in order to select a frequency directly.

1. Select "FM" or "AM" and press the controller.
2. Select "MANUAL" and press the controller.

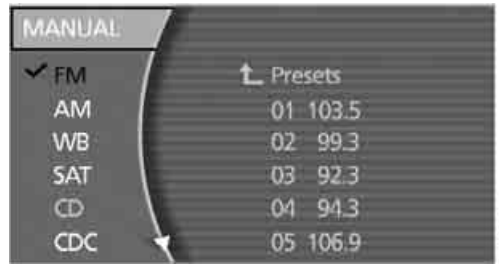

3. Select the frequency display and press the controller.



4. Turn the controller until you reach the desired frequency.
5. Press the controller to save setting.

Using the voice command system:

1. ›Radio‹.
2. ›Frequency 88...107 (Point 1...9)‹.

## Updating selection of stations in receiving range

In the course of longer trips, when you travel outside the transmission range of the originally selected stations, you can update the selection of stations in receiving range.

1. Select "AM" and press the controller.
2. Select "MANUAL" and press the controller.
3. Select "AUTOSTORE" and press the controller.



The selection of stations in receiving range is updated and the frequencies or names of the stations are displayed.

## Station scan

You can tune in to stations that are received in addition to those on the display.

The frequency of the station is displayed in the bottom status line and also on the Control Display.

## Using buttons in center console

Press and hold the ◀ ▶ button for the corresponding direction.

The system switches to the next station.

## Using iDrive

1. Select "FM" or "AM" and press the controller.
2. Select "MANUAL" and press the controller.

3. ◀ ▶ Select the desired direction and press the controller.



The system switches to the next station. The frequency is shown on the Control Display.

## Storing a station

The station you are currently listening to can be stored.

You can also manually store stations in the "Autostore list" if this selection has been made before storing.

iDrive, for principle details, refer to page 16.

1. Press the **MENU** button to open the start menu.
2. Move the controller toward "Entertainment".
3. Select "FM" or "AM" and press the controller.
4. Choose the selection criterion and press the controller.
5. Select "MANUAL" and press the controller.

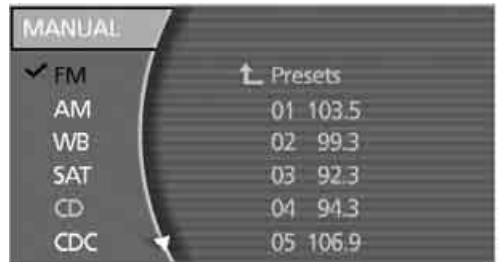

6. Select "STORE" and press the controller.





7. Turn the controller until you reach the desired memory position.
8. Press the controller.

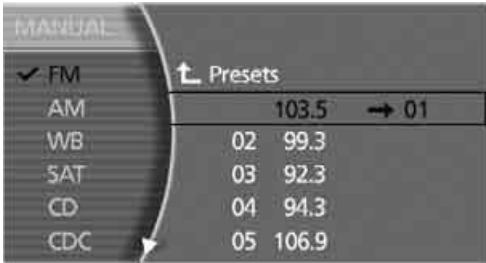

The stations are stored for the remote control currently in use.

Using the voice command system:

1. ›Radio‹.
2. ›Station 1...12‹.

### Changing memory position

1. Select the desired station and press the controller.
2. Turn the controller until you reach the desired memory position.
3. Press the controller.

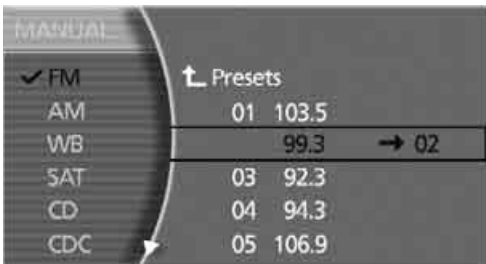

The station is now stored.

## RDS Radio Data System\*

RDS also broadcasts information on the VHF/ FM waveband. RDS stations have the following properties for this purpose:

- ▷ In broadcasting companies that broadcast over several frequencies, the system automatically switches to the frequency with the best reception quality.
- ▷ If the reception conditions are good, the station names are shown on the Control Display. With weaker reception or when there is interference, it can take a while for the station names to appear.

### Switching RDS on/off

1. Select "FM" and press the controller.
2. Choose the selection criterion and press the controller.
3. Select "MANUAL" and press the controller.
4. Select "RDS" and press the controller.



▷ RDS is available in the FM waveband. ◀

## Weather reports\*

Weather Radio is a service of the National Oceanic and Atmospheric Administration (NOAA) of the US Department of Trade. Weather reports are repeated every 4 to 6 minutes and are routinely updated at intervals of 1 to 3 hours, more often when necessary. Most stations operate 24 hours a day. In case of a storm, the National Weather Service interrupts the routine weather news and transmits special warning messages instead. Should you have questions regarding NOAA Weather Radio,

please contact the nearest office of the National Weather Service or write to the National Weather Service at: W/OM1, National Oceanic and Atmospheric Administration, 1325 East-West Highway, Silver Spring, MD 20910.

## Calling up weather reports

iDrive, for principle details, refer to page 16.

1. Press the **MENU** button to open the start menu.
2. Move the controller toward "Entertainment".
3. Select "WB" and press the controller. A list of the available channels is displayed.
4. Turn the controller until the desired channel is selected and press the controller.



The display shows a list of weather band stations

 In some regions, only one or two channels can be received or Weather Band channels are unavailable. ◀

Using the voice command system

1. ›Weatherband◁.
2. ›Channel 1...7◁.

## Satellite radio\*

You can receive approx. 100 different channels with high sound quality.

The channels are offered to you in predefined packages. To listen to the channels of your choice, you must have these channels enabled.

With this new technology the signal may fail, causing interruptions in reception.

Using the voice command system:

1. ›Satellite Radio◁ or ›SDARS◁.
2. ›Turn on◁.

## Enabling or disabling channels

iDrive, for principle details, refer to page 16.

1. Press the **MENU** button to open the start menu.
2. Move the controller toward "Entertainment".
3. Select "SAT" and press the controller.
4. Select "Channels" and press the controller.



The channels that can be received are shown in the list.

5. Select channel and press the controller. A phone number and the electronic serial number, ESN, are displayed.

 The electronic serial number is required to enable or disable. ◀

6. Dial the displayed telephone number to have the channel enabled or disabled. During the enabling or disabling process, leave the ignition switched on.

✔ These channels are enabled.

## Channel selection

### Using buttons in center console

Press the  button for the corresponding direction until you reach the next station.

Using the voice command system:

1. ›Satellite Radio◁ or ›SDARS◁.
2. ›Previous station◁ or ›Next station◁

## Using iDrive

1. Select "SAT" and press the controller.
2. Choose the selection criterion and press the controller.
  - ▷ "Channels":  
All channels are displayed.
  - ▷ "Categories":  
All channels are displayed, sorted according to categories.
  - ▷ "Presets":  
Up to twelve channels that you have previously stored are displayed.



3. Select channel and press the controller.

Using the voice command system:

- ▷ ›Satellite Radio‹ or ›SDARS‹.
- ▷ ›Previous station‹ or ›Next station‹
- ▷ ›Previous‹ or ›Next‹.

Select a stored channel:

- 1. ›Satellite Radio‹ or ›SDARS‹.
- 2. ›Station 1...12‹.

## Displaying additional information

Select the channel currently being played and press the controller.



The name of the station, the name of the artist, and the title of the track are displayed.

## Notes

If no signal can be received for more than 4 seconds, a message appears on the Control Display.

▶ Reception may not be possible for certain reasons, e.g. environmental influences or topographical conditions. The satellite radio has no influence on this.

The signal may not be available in tunnels or underground garages, next to tall buildings, near trees, mountains or other powerful sources of radio interference.

Reception is usually possible again as soon as the signal is available once more. ◀

## Storing a station

1. Select "SAT" and press the controller.
2. Select "Channels" and press the controller.
3. Select the desired station.
4. Select "STORE" and press the controller.



The list of stored stations appears on the display.

5. Select the desired station.
6. Turn the controller until you reach the desired memory position.

- Press and hold the controller.

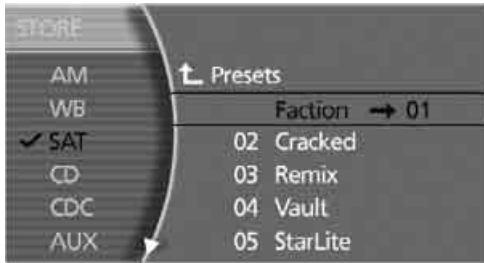

## High Definition Radio\*

Many stations transmit both analog and digital signals. You can receive these stations digitally and with improved sound quality.

### Activating and deactivating digital radio reception

iDrive, for principle details, refer to page 16.

- Press the **MENU** button to open the start menu.
- Move the controller toward "Entertainment".
- Select "FM" or "AM" and press the controller.
- Select "MANUAL" and press the controller.
- Select "HD" and press the controller.



The reception of digital stations is activated. "HD" is shown in the status line when a station is received digitally.

Some digital stations broadcast several programs on their frequency. The analog radio allows you to access these programs and the following functions:

- ▷ Selecting frequency manually, page 157
- ▷ Station search, page 158.

The lower status line indicates the program currently selected.

With some stations the digital signals are not transmitted simultaneously with the analog signals. If you are in an area in which the selected station is not continuously received digitally, playback switches between analog and digital reception. This can result in repetitions or interruptions. In this case it may be advisable to deactivate digital radio reception.

### Displaying additional information

With the digital stations, additional information on the current track is displayed, e.g. the name of the album or the artist.

Select the channel currently being played and press the controller.

 "HD" must appear in the status line and the system must currently be receiving a digital station. ◀

# CD player\*

## Listening to CDs

1. Switch Entertainment sound output on, refer to page 153.
2. Insert the CD with the labeled side up. The CD is automatically pulled in. To start playback when a CD is already in the player:

iDrive, for principle details, refer to page 16.

1. Press the **MENU** button to open the start menu.
2. Move the controller toward "Entertainment".
3. Select "CD" and press the controller.

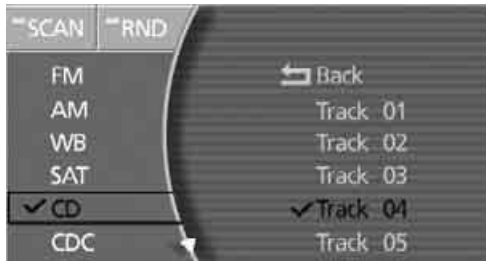

Using the voice command system:

1. ›CD⟨.
2. ›CD on⟨.

## Selecting tracks

### Using buttons in center console

Press the ◀ ▶ button repeatedly, continuing until you reach the desired track on the current CD.

Using the voice command system:

1. ›CD⟨.
2. ›Next⟨ or ›Back⟨.

## Using iDrive

Turn the controller to select the track and press to confirm.

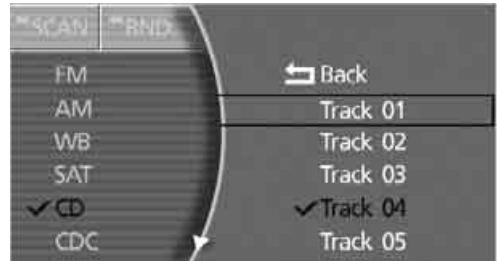

Using the voice command system:

1. ›CD⟨.
2. ›Track 1...30⟨.

## Sampling tracks, Scan

The system automatically plays a series of brief samples from each of the tracks on the current CD.

Select "SCAN" and press the controller.



Scan starts.

To end scan:

Press the controller or press the ◀ ▶ button. Scan is interrupted and the currently selected track is played.

## Random play sequence

All of the tracks on the current CD are played at least once in a random sequence.

Select "RND" and press the controller.



Cancel random playback:

Select "RND" and press the controller.

## Fast forward/reverse

Press and hold the  button for the corresponding direction.

The tracks can be heard, but the sound is distorted.

## Notes

 The BMW CD player is a Class 1 laser product. Never remove the cover from the housing. Do not operate with a damaged cover panel as this can lead to severe eye injury. Never play CDs or DVDs with stick-on labels. They can come loose during playback due to the heat buildup and cause irreparable damage to the system.

Only use round CDs with a standard diameter of 4.7 in/12 cm and do not play CDs with an adapter, e.g. CD singles; otherwise, the CDs or the adapter can jam and may no longer eject properly. ◀

## General malfunctions

The BMW CD player is optimized for operation in the vehicle. It may react more sensitively to defective CDs than devices intended for stationary use.

If a CD cannot be played back, first check to make sure it has been correctly inserted.

## Humidity

High humidity can fog the CD or the focusing lens for the laser beam, temporarily preventing playback.

## Malfunctions with individual CDs

If malfunctions occur only with particular CDs, this can be due to one of the following causes.

## Home-recorded CDs

Malfunction sources in home-recorded CDs include, for example, inconsistent data origination and recording processes as well as low quality or pronounced aging of the blanks used.

Only write on CDs with a marker especially designed for this purpose.

## Damaged CDs

Avoid finger prints, dust, scratches, and moisture.

Store CDs in a sleeve.

Do not expose CDs to temperatures above 122 °F / 50 °C, high humidity or direct sunlight.

## CDs with copy protection

Manufacturers often provide CDs with copy protection. This can prevent or limit the playback of these CDs.

## Care instructions

You can find everything you need to know about this topic by consulting the separate Caring for your vehicle brochure.

# CD changer\*

## Installation location

The BMW CD changer for six CDs is installed above the glove compartment.

## Compressed audio files

The CD changer can play CDs with compressed audio files, such as MP3s.

## Removing CD magazine

To insert CDs into the CD magazine or remove them from it, you must first remove the magazine from the CD changer:

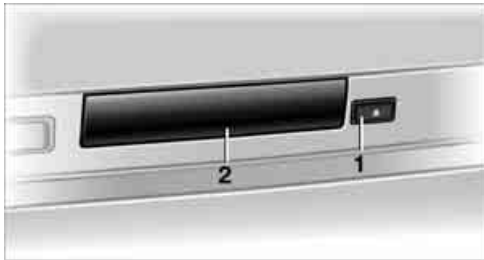

1. Press button 1.  
The lid 2 opens and the magazine is ejected.
2. Remove magazine.

## Inserting/removing CDs into/from CD magazine



When inserting or removing CDs always remember to grasp them by the edges only, taking care to avoid touching the reflective data side.

- ▷ To insert: insert the CD into a CD slot with the label side up.
- ▷ To remove: pull out the desired tray, refer to arrow, and remove the corresponding CD.

## Inserting CD magazine



1. Press button 1.  
The lid opens.
2. Slide the magazine 2 in as far as possible in the direction of the arrow.  
The lid closes automatically.

The CD changer automatically reads in the loaded CDs and is then ready for operation.

For CDs with compressed audio files, it can take up to approx. 1 minute per CD to read in the data, depending on the directory structure.

## Listening to CDs

1. If necessary, switch on the Entertainment sound output, refer to page 153.
2. If necessary, fill and insert the CD magazine.
3. Press the **MENU** button to open the start menu.
4. Move the controller toward "Entertainment".

5. Select "CDC" and press the controller.

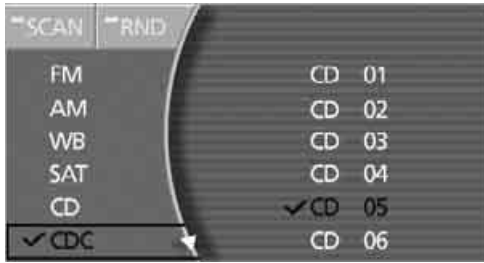

6. Select the desired CD and press the controller.

CD playback starts on the first track. At the end of the last track, the next CD will be selected.

The CD magazine's load status is indicated on the Control Display.

 If the display fails to detect a CD that you have loaded into the magazine, make sure that the CD has been inserted correctly and inspect it for signs of defects. If simultaneously equipped with a DVD changer, up to twelve CDs can be played back. ◀

Using the voice command system:

1. ›CD changer◁.
2. ›CD on◁.

## Selecting tracks

### Using buttons in center console

Press the  button repeatedly, continuing until you reach the desired track on the current CD.

Using the voice command system:

1. ›CD changer◁.
2. ›Next◁ or ›Back◁.

## Using iDrive

Turn the controller to select the track and press to confirm.

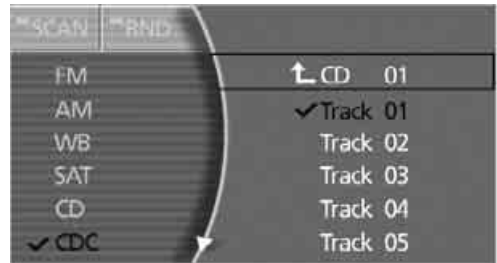

Using the voice command system:

1. ›CD changer◁.
2. ›CD Track 1...30◁.

## Compressed audio files

CDs with compressed audio files such as MP3s are identified with a star.

1. Select directory if need be and press the controller.

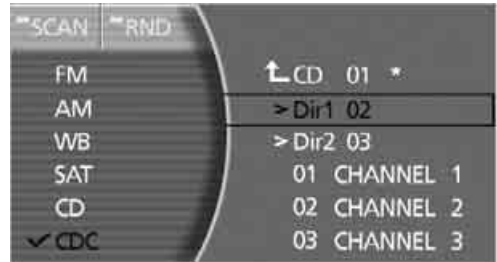

2. Select the track and turn the controller to start playback.



To change directories:

Select directory and press the controller.



Using the voice command system:

1. ›CD changer◁.
2. ›CD on◁.
3. ›CD 1...6◁.

## Displaying track information

With compressed audio files, you can display any additional stored information about the current track, e.g. the name of the artist and title of the album.

During playback, press the controller.

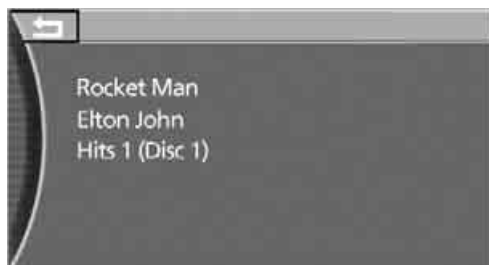

This displays additional stored information about the current track, also refer to Status lines on page 20.

## Sampling tracks, Scan

The system automatically plays a series of brief samples from each of the tracks on the current CD.

Select "SCAN" and press the controller.



To end scan:

Press the controller or press the ◀▶ button. Scan is interrupted and the currently selected track is played.

## Random play sequence

All of the tracks on the current CD are played at least once in a random sequence.

Select "RND" and press the controller.

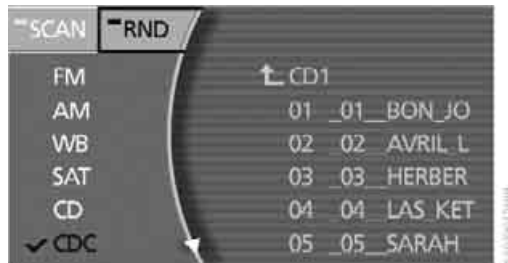

Cancel random playback:

Select "RND" and press the controller.

## Fast forward/reverse

1. Select the direction.  
Press the ◀▶ button longer.  
The tracks can be heard, but the sound is distorted.
2. To interrupt the fast forward/reverse function, release the button.  
The system will continue play at the point on the CD at which the button was released.

## Notes

**!** The BMW CD changer is a Class 1 laser product. Never remove the cover from the housing. Do not operate with a damaged cover panel as this can lead to severe eye injury. Never play CDs or DVDs with stick-on labels. They can come loose during playback due to the heat buildup and cause irreparable damage to the system.

Only use round CDs with a standard diameter of 4.7 in/12 cm and do not play CDs with an adapter, e.g. CD singles; otherwise, the CDs or the adapter can jam and may no longer eject properly. ◀

## General malfunctions

The BMW CD changer is optimized for operation in the vehicle. It may react more sensitively to defective CDs than devices intended for stationary use.

If a CD cannot be played back, first check to make sure it has been correctly inserted.

## Humidity

High humidity can fog the CD or the focusing lens for the laser beam, temporarily preventing playback.

## Malfunctions with individual CDs

If malfunctions occur only with particular CDs, this can be due to one of the following causes.

### Home-recorded CDs

Malfunction sources in home-recorded CDs include, for example, inconsistent data origination and recording processes as well as low quality or pronounced aging of the blanks used.

Only write on CDs with a marker especially designed for this purpose.

### Damaged CDs

Avoid finger prints, dust, scratches, and moisture.

Store CDs in a sleeve.

Do not expose CDs to temperatures above 122 °F /50 °C, high humidity or direct sunlight.

### CDs with copy protection

Manufacturers often provide CDs with copy protection. This can prevent or limit the playback of these CDs.

## Care instructions

You can find everything you need to know about this topic by consulting the separate Caring for your vehicle brochure.

# External audio device

You can connect an external audio device, for instance an MP3 player, and output the sound to vehicle's speaker system. You can adjust the tone using iDrive.

It is recommended that the external audio device be set to a mid-level volume and neutral tone settings. The tone may depend on the quality of the audio data.

## Connecting

Fold the cover of the center armrest upward.

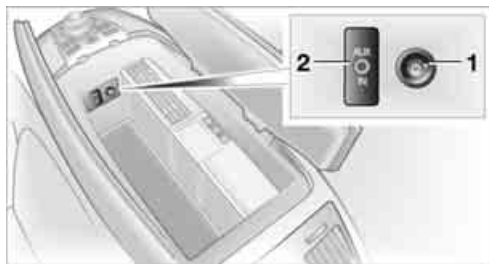

- 1 Power supply for your external audio device:  
Socket with removable cap
- 2 Connection for audio playback:  
Jack 0.14 in/3,5 mm

For audio playback over the vehicle's speaker system, connect the headset or line-out port of the external device to connection 2.

## Starting audio playback

The audio device must be switched on.

iDrive, for principle details, refer to page 16.

1. Press the **MENU** button to open the start menu.
2. Move the controller toward "Entertainment".
3. Select "AUX" and press the controller.

## Adjusting volume

The volume at which the sound from the external audio device is played back in the vehicle depends on the audio device. If this volume differs sharply from that of the other audio and video sources, then it makes sense to adjust the volumes.

1. Select "AUX level" and press the controller.



2. Turn the controller to adjust the volume and press the controller.

The volume setting is saved when the device is disconnected from the vehicle.

# DVD changer\*

## Installation location



The BMW DVD changer for six DVDs or audio CDs is mounted behind the left side trim panel in the luggage compartment.

## Removing DVD magazine

To insert DVDs into the DVD magazine or remove them from it, you must first remove the magazine from the DVD changer:



1. Push the door to the right, refer to arrow 1.
2. Press the button, arrow 2.  
The magazine is ejected.

## Inserting/removing DVDs/CDs into/ from DVD magazine



When inserting or removing DVDs or CDs, always remember to grasp them by the edges only, taking care to avoid touching the reflective data side.

- ▷ To insert: insert the DVD or CD into a magazine slot with the label side up.
- ▷ To remove: pull out the desired tray and remove the corresponding DVD or CD, as shown in the illustration.

## Inserting DVD magazine

1. Slide the door to the right.
2. Slide the magazine in until it reaches the stop, refer to arrow.

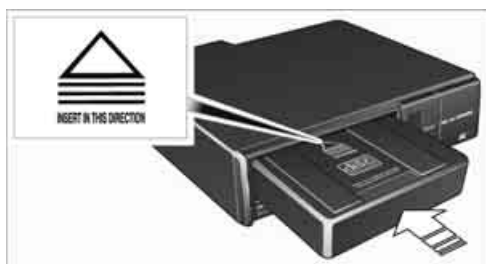

3. Close the door again.

The DVD changer automatically reads in the loaded DVDs or CDs and is then ready for operation.

## DVD country codes

Your DVD changer will only play back DVDs coded for your home region, e.g. USA, Canada = 1. The country code supported by your DVD is indicated in the information supplied with the DVD. This coding cannot be changed. An overview of the six coding zones:

Code	Region
1	USA, Canada
2	Japan, Europe, Near East, South Africa
3	Southeast Asia
4	Australia, Central and South American, New Zealand
5	Northwest Asia, North Africa
6	China

 DVDs with the Code 0 can be played on all devices. ◀

## Playing DVDs

Playback is only possible on the rear seat screen, refer to Rear seat screen\* on page 21.

1. If necessary, switch on the Entertainment sound output, refer to page 153.
2. If necessary, fill and insert the DVD magazine.
3. Press the **MENU** button to open the start menu.
4. Move the controller toward "Entertainment".
5. Select "DVD" and press the controller.

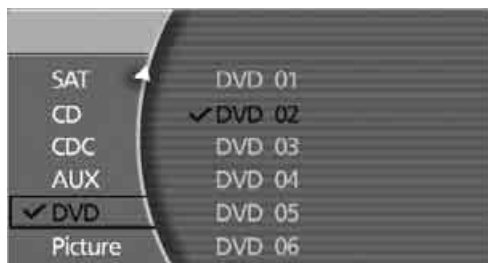

After a few seconds, play will resume at the point where playback was previously interrupted.

The DVD magazine's load status is indicated on the Control Display.

 If the display fails to detect a DVD that you have loaded into the magazine, make sure that the DVD has been inserted correctly and inspect it for signs of defects.

If there are audio CDs in the DVD magazine, these will not be displayed in the DVD menu, but instead in the CD changer menu. ◀

Using the voice command system:

1. ›DVD on◀.
2. ›DVD 1...6◀.

## DVD control

With the DVD controller, you can select the track and chapter, open the DVD-specific menu and operate functions such as Language, Fast forward and Reverse or Freeze frame.

A DVD can briefly deactivate functions of the DVD control, under certain circumstances even during playback of the entire DVD. It is not possible to operate the DVD control under these circumstances. In this case, try to make the selection using the DVD-specific menu.

During playback:

Press the controller to display the DVD control.



The DVD controller disappears again after a short time if you have not selected a function.

Softkey	Function
▶	Start playback
■	Stop playback
↶	Close DVD controller
⏸	Activate and deactivate freeze frame
⏮ ⏭	Skip chapter
⏪ ⏩	Fast forward/reverse
⬆ ⬇ ⬇ ⬆	DVD-specific menu: Select functions
⏪ ⬆	DVD-specific menu: Return to previous menu

## Fast forward/reverse

### Forward/reverse with DVD control

1. During playback, press the controller to display the DVD control.
2. Select ⏪ ⏩ and press the controller.
3. To increase the fast forward/reverse speed, press the controller several times. The DVD playback will be distorted.

To cancel fast forward/reverse:

Select ▶ and press the controller. The DVD will start play at the point selected.

### Forward/reverse with controller

1. During playback, turn the controller. Fast forward/reverse is started.
2. Turn the controller further. The speed is increased.
3. Release the controller. Fast forward/reverse is interrupted. The system will continue play at the point on the DVD at which the controller was released.

## Skipping chapter

You can change to the next or previous chapter during playback.

1. During playback, press the controller to display the DVD control.
2. Select ⏮ ⏭ and press repeatedly until you reach the desired chapter.

or:

Press the ◀ ▶ button on the left or right repeatedly until you reach the desired chapter.

## Adjusting picture

1. During playback, press the controller to display the DVD control.
2. Select ■ and press the controller.
3. Select the ↶ arrow and press the controller.
4. Select "Picture" and press the controller.

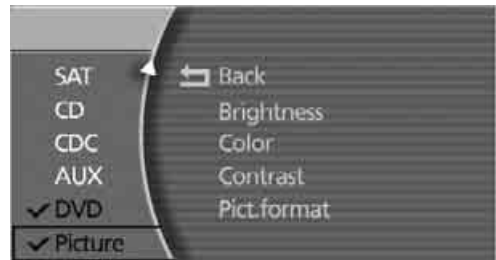

5. Select "Brightness", "Color", or "Contrast" and press the controller.
6. Turn the controller until you reach the desired setting.

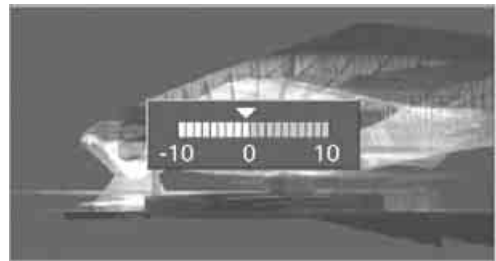

7. Press the controller to save the setting.

## Freeze frame

1. During playback, press the controller to display the DVD control.  
The film is stopped.
2. Select **⏏** at the desired point and press the controller.  
The film is stopped.
3. Select **▶** or **⏏** and press the controller to cancel the freeze frame.  
DVD playback is continued at the point at which it was interrupted.

## Selecting picture format

You can adjust the DVD format to your screen. The picture format is a DVD-specific function and is not available on all DVDs.

1. During playback, press the controller to display the DVD control.
2. Select **■** and press the controller.
3. Select the **↩** arrow and press the controller.
4. "Picture" and press the controller.



5. Select "Pict.format" and press the controller.



6. Select the desired picture format and press the controller.



Color settings can be adjusted separately for the Control Display and the rear seat screen. ◀

## Selecting language, subtitles and viewing angle

Many DVDs offer dialogue and subtitles in various languages or scene descriptions for the hearing impaired. In addition, with some DVDs, the film can be viewed from different camera angles. These functions are stored on the DVD.

1. During playback, press the controller to display the DVD control.
2. Select "FULL MENU" and press the controller.

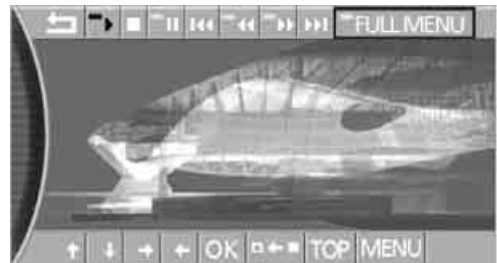

3. Make the desired selection and press the controller:
  - ▷ "TITLE"  
Displaying DVD title.
  - ▷ "AUDIO"  
Selecting different languages.
  - ▷ "SUBTITLE"  
Selecting language of subtitles.
  - ▷ "ANGLE"  
Selecting camera viewing angle.  
Notes or symbols that appear during the playback of a film generally point out different camera angles. They usually only appear briefly.



With some DVDs, it is only possible to select language, subtitles, camera angle, or track by using the DVD-specific menu.

Refer to the information on your DVD for possible selections. ◀





## Opening DVD-specific menu

Additional functions may be available on DVDs. For example, the viewer can select from several possible plots or display information on the film.

1. During playback, press the controller to display the DVD control.
2. Select "MENU" or "TOP" and press the controller.

Selecting "MENU" generally takes you to the DVD-specific main menu. On some DVDs, "TOP" takes you to another menu in which you can select music scenes, for example.

To make a selection:

3. Select    .
4. Select "OK" and press the controller.

To return to a previous menu:

Select  or the  arrow and press the controller.

 You can also select language, subtitles, camera angle, or track in the DVD-specific menu.

Refer to the information on your DVD for possible selections. ◀

## Notes

The DVD changer can play the following formats:

- ▷ Video DVD
- ▷ CD-DA (audio CD)

The DVD Audio format is not supported by the DVD changer. However, many audio DVDs available in stores also contain a video track in the DVD Video format in addition to the audio track. These DVDs can be played back by the DVD changer. Please refer to the information on your DVD to determine whether your audio DVD contains an additional video track.

DVDs are usually divided into tracks and chapters and can contain different subtitles, camera angles or sound tracks, languages and sound formats. Depending on the version of the DVD, these functions can be selected either directly with the DVD control system or only via the DVD-specific menu. Refer to the information on your DVD for possible selections.

Dual-sided DVDs available from retail suppliers are coated on both sides and bear no markings. This means both sides are information carriers. To play back the information on the other side, remove the magazine and turn the DVD over.

## Safety note



The BMW DVD changer is a Class 1 laser product. Do not operate with a damaged cover panel as this can lead to severe eye injury. Never play CDs/DVDs with stick-on labels.

They can come loose during playback due to the heat buildup and cause irreparable damage to the system.

Only use round CDs/DVDs with a standard diameter of 4.7 in/12 cm and do not play CDs/DVDs with an adapter, e.g. CD singles; otherwise, the CD/DVD or the adapter can jam and may no longer eject properly.

Do not use combined CD/DVDs, e.g. DVD<sup>Plus</sup>, otherwise, the CD/DVD can jam, preventing it from being ejected properly. ◀

## General malfunctions

The BMW DVD changer is optimized for operation in the vehicle. It may react more sensitively to defective CDs/DVDs than devices intended for stationary use.

If a CD/DVD cannot be played back, first check to make sure it has been correctly inserted.

## Humidity

High humidity can fog the CD/DVD or the focusing lens for the laser beam, temporarily preventing playback.



## Malfunctions with particular CDs/DVDs

If malfunctions occur only with particular CDs/DVDs, this can be due to one of the following causes.

### Home-recorded CDs/DVDs

Malfunction sources in home-recorded CDs/DVDs include, for example, inconsistent data origination and recording processes as well as low quality or pronounced aging of the blanks used.

Only write on CDs/DVDs with a marker especially designed for this purpose.

### Damaged CDs/DVDs

Avoid finger prints, dust, scratches, and moisture.

Store CDs/DVDs in a sleeve.

Do not expose CDs/DVDs to temperatures above 122 °F / 50 °C, high humidity or direct sunlight.

### CDs/DVDs with copy protection

Manufacturers often provide CDs/DVDs with copy protection. This can prevent or limit the playback of these CDs/DVDs.

### Care instructions

You can find everything you need to know about this topic by consulting the separate Caring for your vehicle brochure.



## **Communications**

This chapter describes the extensive array of options available for mobile communications with family, friends, business associates and service providers.

# Telephone overview\*

## The concept

Your BMW is equipped with a mobile phone preparation package. After a suitable mobile phone has been paired with the vehicle once, you can operate the mobile phone via iDrive, via the button on the steering wheel, via the phone keypad and by voice\*.

A mobile phone that has been paired with the vehicle once is automatically detected again with the engine running or the ignition switched on as soon as it is brought inside the vehicle. The logon data of up to four mobile phones can be stored simultaneously. If several mobile phones are detected simultaneously, then the vehicle can be used to operate the mobile phone that was most recently paired with it.

## Using a phone in your vehicle

### Using snap-in adapter\*

The so-called snap-in adapter, a cradle for your mobile phone, is inserted into the center armrest. If the mobile phone is inserted into the snap-in adapter, the battery is charged and the mobile phone is connected to the external antenna of the vehicle whenever the ignition key is in the radio ready state or higher. This assures better network reception and uniform sound quality. Ask your BMW center which mobile phones snap-in adapters are offered for. To use the snap-in adapter, refer to page 181.

 BMW discourages the use of mobile phones or other mobile communications devices inside the vehicle without a direct connection to an outside antenna. Otherwise, the vehicle electronics and mobile communications device can interfere with each other. In addition, there is no assurance that the radiation generated during transmission will be discharged from the vehicle interior. ◀

Avoid operating a mobile phone detected by the vehicle with the keypad of the mobile phone; otherwise, malfunctions can occur.

The mobile phone can be operated by means of:

- ▷ the button on the steering wheel, refer to page 11
- ▷ the retracting telephone keypad, refer to page 179
- ▷ iDrive, refer to Initiating communication, page 184
- ▷ the voice command system\*, refer to page 23

For information on operating your mobile phone, please consult the separate operating instructions.

### For your safety

 Only make entries when the traffic situation allows you to do so. Do not hold the mobile phone in your hand while you are driving; use the hands-free system instead. If you do not comply with this precaution, your being distracted can endanger vehicle occupants and other road users. ◀

## Suitable mobile phones

Ask your BMW center which mobile phones with a Bluetooth interface are supported by the mobile phone preparation package or which mobile phones snap-in adapters are available for. These mobile phones support the functions described in this Owner's Manual with a certain software version. Malfunctions can occur with other mobile phones.

## Hands-free system

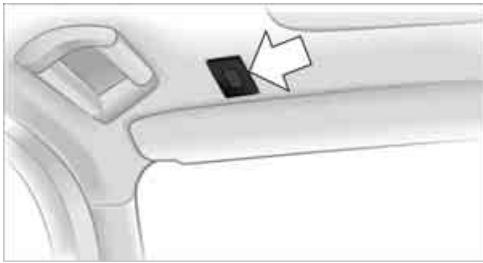

The hands-free microphone is located on the left-hand side on the headliner.

The hands-free system is activated whenever you establish or receive a call using the following:

- ▶ the button on the steering wheel, refer to page 11
- ▶ the retracting telephone keypad
- ▶ iDrive, refer to Initiating communication, page 184
- ▶ the voice command system\*, refer to page 23, except for incoming calls

## Volume adjustment

You can set the volume for the hands-free system and the ring tone separately:



- ▶ Turn knob during a call.
- ▶ Turn knob during an incoming call.
- ▶ The volume can also be adjusted using the buttons on the steering wheel. ◀

This volume is maintained, even if the other audio sources are set to minimum volume.

The setting is stored for the remote control currently in use.

## Retracting telephone keypad

The telephone keypad allows you to use all of the basic mobile phone functions without ever picking up the handset.

Calls are automatically routed through the hands-free system.

### Sliding out



Press telephone keypad 1.  
It slides out.





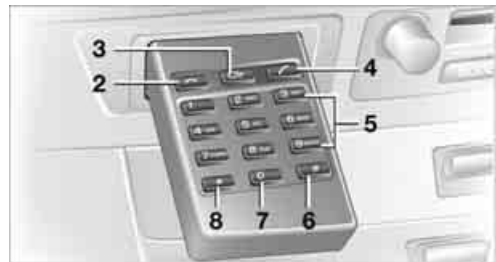

- ▶ It is not possible to remove the telephone keypad. ◀

## Controls





- 2  Rejecting call or terminating connection.
- 3  Press briefly: the last digit entered is deleted.  
Press and hold: the entire number is deleted.
- 4  Accepting call or establishing connection.

- 5  Entering digits 1-9.
- 
- 6  Entering special characters.
- 7  Entering the digit 0.
- 8  Press briefly: entering special characters.  
Press and hold\*: pause for touch tone dialing.

## Touch tone dialing

You can use the touch tone dialing to access network services or to control devices, e.g. for remotely checking the messages on a telephone answering machine. This requires the corresponding digits or number combination, the touch tone code.

You can use the touch tone dialing during a connection.

1. Enter the phone number.
2. Press the  button to establish the connection.
3. Press the  button longer.
4. Enter the desired digits or number combinations according to the touch tone code. Each digit or number is transmitted immediately, which is indicated by a tone.

## Sliding in

Slide telephone keypad in until it engages.

## Emergency call\*

Initiating an emergency call and prerequisites for an emergency call, refer to page [219](#).

# Getting started

## Snap-in adapter\*

The so-called snap-in adapter, a cradle for your mobile phone, is inserted into the center arm-rest. If the mobile phone is inserted into the snap-in adapter, the battery is charged and the mobile phone is connected to the external antenna of the vehicle whenever the ignition key is in the radio ready state or higher. This assures better network reception and uniform sound quality. Ask your BMW center which mobile phones snap-in adapters are offered for.

### Inserting

1. Press buttons to open cover of center arm-rest.



2. Press area around button, arrows 1, and take out the cover, arrow 2.



3. Insert top of snap-in adapter, arrow 3, and press lower region forward, arrow 4.



### Removing

Press area around button, arrows 1, and take out snap-in adapter, arrow 2.



## Inserting mobile phone

If you insert the mobile phone into or remove it from the snap-in adapter during a call, the call may be interrupted, depending on the mobile phone model.

1. Press buttons to open cover of center arm-rest.



2. Remove the protective cap from the mobile phone's antenna connector if necessary, so that the mobile phone can engage in the snap-in adapter.
3. Push the mobile phone downward toward the electrical connections, arrow **1**, and press forward, arrow **2**, until it engages.



The battery is charged starting from radio ready state of the vehicle, refer to charge indicator on mobile phone.

## Removing mobile phone

To remove mobile phone, depending on model:

- ▷ Press the button.
- ▷ Push the button upward.

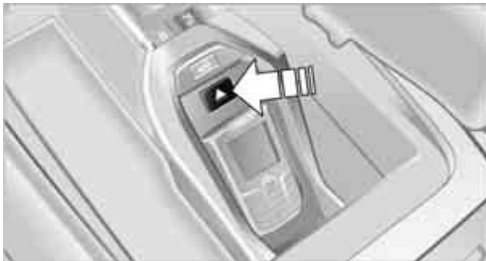

## Pairing mobile phone with vehicle

To pair your mobile phone with the vehicle, you need a special Bluetooth passkey. This is included in the information kit.

The following prerequisites must be met:

- ▷ The ignition is switched on.
- ▷ The mobile phone is ready for operation.

- ▷ The Bluetooth connections in the vehicle and the mobile phone are activated.
- ▷ Depending on the mobile phone model, certain presets are required on the mobile phone, e.g. detecting, connecting or pairing Bluetooth unit, refer to the operating instructions of your mobile phone.

 Only pair the mobile phone with the vehicle stopped; otherwise, the passengers and other road user can be endangered due to a lack of attentiveness on the part of the driver. ◀

## Preparation via iDrive

iDrive, for principle details, refer to page 16.

1. Press the **MENU** button to open the start menu.
2. Move the controller toward "Settings".
3. Select "Phone" and press the controller.
4. Select "PAIRING" and press the controller. The three LEDs in the status line flash, refer to page 20.

 The mobile phone can also be paired with the vehicle via "Communication". When pairing, follow the instructions that appear in the Control Display. ◀



## Establishing connection between mobile phone and vehicle

5. Additional operations must be carried out on the mobile phone and differ depending on the model, refer to the operating instructions of your mobile phone, e.g. under searching for, connecting to, or linking to a Bluetooth device.
6. Enter and confirm Bluetooth passkey using your mobile phone keypad. Following successful logon, the name of



your mobile phone will appear on the Control Display.

The next time you use the mobile phone within Bluetooth range of the vehicle, it will be detected within a short time with the ignition switched on.

As soon as the vehicle detects a mobile phone, the phone book entries stored on the SIM card and/or in your mobile phone are transmitted to your vehicle. This transfer is dependent on your mobile phone, refer to the operating instructions of your mobile phone if necessary, and can take several minutes.

During each connection, the phone book entries present in the vehicle are calibrated with the phone book entries currently stored in the mobile phone. The entries in the vehicle are added to or deleted as needed in the process of this.

Up to four mobile phones can be paired one after the other. If you want to pair a fifth mobile phone, the logon data of one mobile phone must first be deleted, refer to Unpairing mobile phone from vehicle.

## Unpairing mobile phone from vehicle

If you no longer want to operate a particular mobile phone via the vehicle, you can delete the pairing data of the mobile phone.

iDrive, for principle details, refer to page 16.

1. Press the **MENU** button to open the start menu.
2. Move the controller toward "Settings".
3. Select "Phone" and press the controller.
4. Select the desired mobile phone and press the controller.
5. Select "YES" and press the controller. The unpaired mobile phone is deleted from the list. The phone book entries for this phone stored in the vehicle will also be

deleted in the process of unpairing the phone.

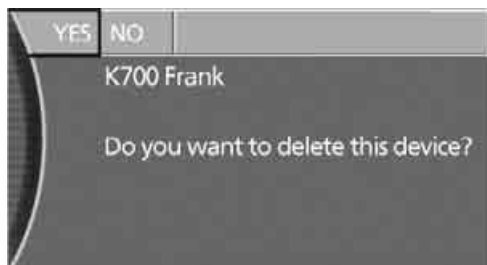

## Activating/deactivating Bluetooth link

 Bluetooth technology is not approved in all countries. Observe the applicable local regulations. Temporarily deactivate the Bluetooth link between the vehicle and the mobile phone if necessary. ◀

1. Press the **MENU** button to open the start menu.
2. Move the controller toward "Settings".
3. Select "Phone" and press the controller.
4. Select "BLUETOOTH" and press the controller.



- ▷ The LED next to "BLUETOOTH" lights up in green:  
The Bluetooth connection is activated.
- ▷ The LED next to "BLUETOOTH" does not light up:  
The Bluetooth connection is deactivated.

# Using the phone

You have the option of controlling the phone using various parts of the vehicle equipment:

- ▷ the button on the steering wheel, refer to page 11
- ▷ the retracting telephone keypad, refer to page 179
- ▷ iDrive, refer to Initiating communication
- ▷ the voice command system\*, refer to page 23

The phone number appears on the upper status line, refer to page 20.

With the ignition switched off, you can continue an ongoing call for a maximum of 16 minutes via the hands-free system.

## Requirements

- ▷ The logon data of the mobile phone are stored in the vehicle and the mobile phone is ready to operate.
- ▷ The ignition is switched on.
- ▷ The mobile phone is detected by the vehicle.

## Initiating communication

iDrive, for principle details, refer to page 16.



1. Press the **MENU** button to open the start menu.
2. Move the controller toward "Communication".



## Receiving calls



If you have the phone number of the caller stored in the phone book and the phone number has been transmitted, the name of the entry is displayed.

### Accepting a call



- ▷ Press the  button on the steering wheel.
- ▷ Press the  button on the retracting telephone keypad.
- ▷ Select the  symbol on the Control Display and press the controller.

The phone number or name are shown in the status line.

### Rejecting a call

- ▷ Press the  button on the retracting telephone keypad.
- ▷ Select the  symbol on the Control Display and press the controller.

### Ending a call

- ▷ Press the  button on the steering wheel.
- ▷ Press the  button on the retracting telephone keypad.
- ▷ Select the  symbol on the Control Display and press the controller.

## Making calls

### Dialing a phone number and establishing a connection

#### Retracting telephone keypad

1. Enter the phone number.
2. Press the  button.

## Voice command system\*

The system recognizes digits from zero to nine. You can say each digit individually or group them into a sequence to speed up the entry process:

1. ›Dial number‹.
2. Say the phone number.
3. ›Dial‹.



After the last spoken sequence of digits has been repeated by the system, you can delete this sequence of digits:

1. ›Correction‹.
2. Correct the phone number.

With ›Delete number‹ all digits previously entered are deleted:

1. ›Delete Number‹.
2. Phone number is deleted.

## Redialing

- ▷ Press the  button on the steering wheel.
- ▷ Press the  button on the retracting telephone keypad.

Using the voice command system:

1. ›Redial‹.

## Dialing a number from phone book or from numbers stored in a list

Phone numbers you have called, missed calls, and the entries of the phone book of the SIM card or of the mobile phone are stored in lists when the mobile phone is connected to the vehicle via Bluetooth. If the caller is listed in the phone book, the name of the entry is displayed instead of the phone number.

The following lists are available:

- ▷ "TOP 8":  
The eight phone numbers in the phone book that are called most frequently are automatically stored in the Top 8 list. The number called most often appears at the top of the list.

- ▷ "Last":  
The last eight phone numbers you have dialed are automatically stored. The last number dialed is at the top of the list.
- ▷ "A-Z":  
The entries in the phone book of the SIM card or of the mobile phone, including name and phone number, are displayed in alphabetical order.
- ▷ "Missed":  
The phone numbers of the last eight calls not accepted are stored, provided that the phone numbers of the callers were transmitted. A missed call is indicated by an envelope symbol in the top status line.

## Dialing phone numbers from phone book

The list "A-Z" is available for you phone book entries. The Control Display shows the entries in the phone book of the SIM card or mobile phone in alphabetical order.

1. Select "A-Z" and press the controller. An alphabetical listing of all the entries in the phone book appears on the right side of the Control Display.
2. Select the desired entry and press the controller.
3. Select the  symbol and press the controller.



The system dials the number. The phone number is displayed in the top status line.

- ▷ The connection can also be established via the button on the steering wheel or the telephone keypad. ◀

## Dialing numbers stored in a list

To select an entry and establish a connection:

1. Select the list and press the controller.
  - ▷ "TOP 8"
  - ▷ "Last"
  - ▷ "Missed"
2. Select the desired entry and press the controller.
3. Select the  symbol and press the controller.

The system dials the number.

The phone number is displayed in the top status line as this happens.

 The connection can also be established via the button on the steering wheel or the telephone keypad. ◀

## Deleting entries in lists

You can delete the lists of the most frequently called phone numbers, missed calls and the last subscribers called.

1. Select the desired list and press the controller.
 

The stored entries are shown on the right side of the Control Displays.
2. Select the  symbol and press the controller to delete all existing entries.
3. Select "YES" and press the controller.

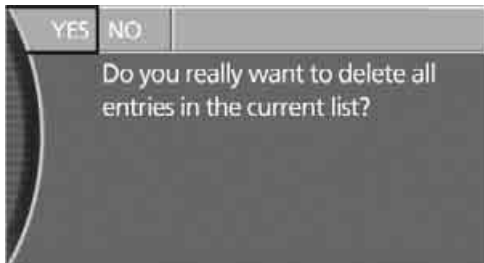

All entries are deleted.

## Voice-command phone book\*

You can use the voice command system to create a separate voice command phone book with up to 50 entries. You must first input all entries by voice command. It is not possible to access iDrive phone book entries by voice command, but you do have the option of importing your phone book entries into the voice command phone book.

### Making a new entry in voice-command phone book

Say the phone number in blocks of three to six digits. An entry always consists of a name and phone number.

1. ›Save name◁.
2. Speak name and repeat entry upon request.
3. Say the phone number.
4. ›Save◁.

### Transferring phone book entries and updating voice command phone book\*

You can import your phone book entries into the voice command phone book and update it:

1. ›Telephone◁.
2. ›Telephone book◁.
3. ›Update telephone book◁.

Each phone number is sent to the voice command phone book individually. The phone number and the name appear on the Control Display. ››Should the entry be saved in the telephone book?◁◁ or ››Save entry?◁◁:

- ▷ ›No◁.  
The next name is displayed.
- ▷ ›Yes◁:  
Say the desired name aloud and repeat it.

You must assign a specific name to each number that you wish to import into the voice-command phone book. These numbers will no longer be requested during updates.

## Having entries read

You can have all the entries of your voice-command phone book read aloud in the order of their input and select a certain entry to establish a connection:

- ›Read out⟨ .
  - ▷ To scroll forward:
    - ›Next⟨
  - ▷ To scroll back:
    - ›Previous⟨
  - ▷ To repeat entry:
    - ›Repeat⟨
  - ▷ To call:
    - ›Dial⟨

## Dialing from voice-command phone book

You can recall a saved entry by the name and dial the phone number:

1. ›Dial name⟨ .
2. Say the name.
3. ›Dial⟨ .

## Deleting entry of voice-command phone book

You can delete individual entries from the voice-command phone book:

1. ›Telephone⟨ .
2. ›Delete entry⟨ .
3. Say the name.
4. Confirm the prompt with ›Yes⟨ .

## Deleting all entries of voice-command phone book

You can delete all entries in the phone book:

1. ›Telephone⟨ .
2. ›Delete telephone book⟨ .
3. Confirm the prompt twice with ›Yes⟨ .

## Switching between mobile phone and hands-free system

You can switch back and forth from the mobile phone to the hands-free system during a call.

### From mobile phone to hands-free system

You can continue calls begun outside the Bluetooth range of the vehicle via the hands-free system when the motor is running or the ignition is switched on.

To do so, place your mobile phone that has already been paired with the vehicle into the snap-in adapter, refer to page 181.

Depending on your mobile phone, the switch to hands-free mode occurs automatically.

With mobile phones that do not switch over automatically to hands-free operation:

- ▷ Press the  button in the upper area of the snap-in adapter.
- ▷ Depending on the mobile phone model used, the conversation can also be continued via the hands-free system if necessary. Follow the instructions given on the mobile phone display, refer to the operating instructions of your mobile phone.

### From hands-free system to mobile phone

When you telephone via the hands-free system, you can also continue the call via the mobile phone if necessary.

iDrive, for principle details, refer to page 16.

1. Press the **MENU** button to open the start menu.
2. Move the controller toward "Communication".

3. Select the  symbol and press the controller.



4. Remove the mobile phone from the snap-in adapter, refer to page [182](#).

You can continue the call via the mobile phone.

BMW Assist offers you various services; for example, the position data of your vehicle can be transmitted to the BMW Assist Response Center if an emergency call\* has been initiated.

Many BMW Assist services depend on the individual contract.

After your contract has expired, the BMW Assist system will be deactivated by the BMW Assist Response Center without your visiting a BMW center. After the BMW Assist system has been deactivated, no BMW Assist service will be available. The BMW Assist system can be reactivated by a BMW center after a new contract has been signed.

## Requirements

You can use BMW Assist when the following requirements are met:

- ▶ The installed BMW Assist system is logged on to a mobile phone network. This network must be capable of transmitting the services.
- ▶ To transmit position data, the vehicle must be able to determine the current position.
- ▶ A GPS signal must be available in order for BMW Assist to be activated and updated.
- ▶ You have signed a BMW Assist subscriber contract at the BMW center or the BMW Assist Response Center. Activation must be completed.
- ▶ BMW Assist is activated, refer to page 193.

## Services offered

The following services are available via BMW Assist:

- ▶ **Emergency call, refer to page 219:**  
When you press the SOS button, a connection is established to the BMW Assist Response Center. The BMW Assist Response Center contacts you and takes further steps to help you.
- ▶ **Automatic emergency call:**  
Once the BMW Assist Response Center has received your emergency call, the BMW Assist Response Center contacts you and takes further steps to help you. Even if you are unable to reply, under certain conditions, the BMW Assist Response Center can still take additional steps to assist you.
- ▶ **Roadside Assistance:**  
You can call the Roadside Assistance\* of the BMW Group should you require help in the event of a breakdown. If possible, the vehicle data and position data are transmitted during this time.
- ▶ **BMW Hotline:**  
For information relating to your vehicle, you can be connected to the BMW Hotline.
- ▶ **TeleService:**  
Information about the service status of your vehicle or required inspections is transmitted to your BMW center either automatically before a service due date or when you request a BMW service appointment.
- ▶ **Vehicle unlocking:**  
Contact the BMW Assist Response Center if you have lost your remote control, for example, and would like to have the vehicle unlocked.
- ▶ **Vehicle search:**  
After you have reported the theft of your vehicle to the police, the BMW Assist Response Center can determine its location.

In addition, other services can be provided to you, such as the information service or route planning, traffic conditions and weather. Press the SOS button in order to contact the BMW Assist Response Center, see below.

## Special features of the services offered

The following special features apply to the services:

- ▷ The services offered are country-specific.
- ▷ Voice contact is established or data are transferred, depending on the equipment and the country. In some countries, it is possible to do both.
- ▷ The data transmitted can be vehicle data, for example, your current position or the data of the CBS Condition Based Service.

## Using services

### Contacting the BMW Assist Response Center

You can establish contact with the BMW Assist Response Center by pressing the SOS button.

1. Briefly press the cover flap to open.



2. Press the button for at least 2 seconds.

Contact will be established with the BMW Assist Response Center.

### Roadside Assistance

iDrive, for principle details, refer to page 16.

1. Press the **MENU** button to open the start menu.
2. Move the controller toward "BMW Assist".

3. Select "BMW center" and press the controller.
4. Select "Roadside Assistance" and press the controller.



If the current position can be determined, the current vehicle location is displayed.

5. Select "START" and press the controller.

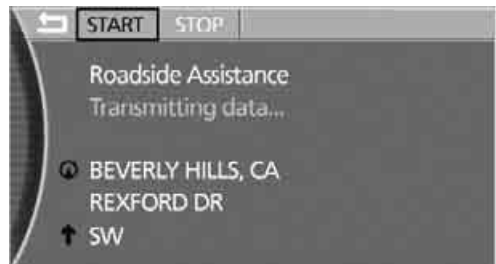

The BMW Assist Response Center connects you to the BMW Group's Roadside Assistance.

## TeleService

### Automatic service notification\*

Information about the service status of your vehicle or required inspections is automatically transmitted before the relevant deadline. You can check when the BMW center was notified. iDrive, for principle details, refer to page 16.

1. Press the **MENU** button to open the start menu.
2. Move the controller toward "BMW Assist".
3. Select "BMW center" and press the controller.



4. Select "Service Status" and press the controller.



5. Select "Status" and press the controller.

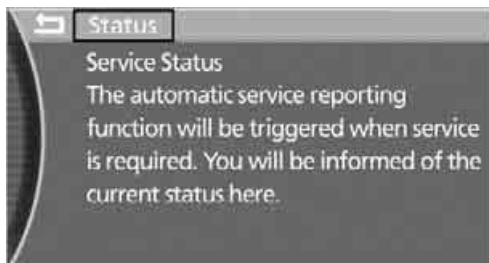

Your BMW dealer will be informed if necessary.



6. Select the  arrow and press the controller to blank out the display.

### Manual service notification

You can transmit information about your vehicle's service status to your BMW center when you wish to arrange a service appointment.

iDrive, for principle details, refer to page 16.

1. Press the **MENU** button to open the start menu.
2. Move the controller toward "BMW Assist".

3. Select "BMW center" and press the controller.
4. Select "Your BMW center" and press the controller.



The current vehicle position is displayed.

5. Select "START" and press the controller. The service-relevant data is transmitted. Your BMW center will contact you to arrange a service appointment.

### Contacting BMW Customer Relations

For information related to your vehicle, you can call BMW Customer Relations.

iDrive, for principle details, refer to page 16.

1. Press the **MENU** button to open the start menu.
2. Move the controller toward "BMW Assist".
3. Select "BMW center" and press the controller.
4. Select "Customer Relations" and press the controller.



The current vehicle position is displayed.

5. Select "START" and press the controller. The BMW Assist Response Center will connect you with BMW Customer Relations.

## Info service\*

When you call BMW Assist's info service, you can obtain information, for example about current events, gas stations or hotels, as well as receive the relevant telephone numbers and addresses. Many hotels can be reserved directly from the BMW info service.

The info service must be enabled separately by the BMW Assist Response Center.

## Calling up information

iDrive, for principle details, refer to page 16.

1. Press the **MENU** button to open the start menu.
2. Move the controller toward "BMW Assist".
3. Select "Concierge" and press the controller.

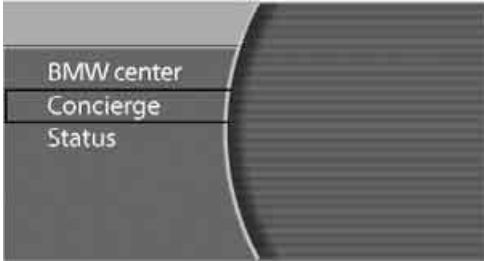

4. Select "New information" and press the controller.



The BMW Assist Response Center connects you to the Info Service.

## Displaying transmitted data

Select a received message, if appropriate, and press the controller.

## Selecting phone number or adopting address into route guidance

- ▷ Use "CALL" to make a telephone call. A prerequisite for this is that your Bluetooth mobile phone is paired with the vehicle.
- ▷ With "AS DEST.", you can adopt the address into the navigation system's route guidance.

## Customizing BMW Assist

### Displaying services

iDrive, for principle details, refer to page 16.

1. Press the **MENU** button to open the start menu.
2. Move the controller toward "BMW Assist".
3. Select "Status" and press the controller.

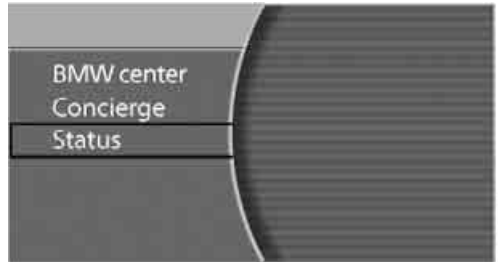

4. Select "Services" and press the controller.



The current services of BMW Assist are displayed.

## Updating services

You will be notified of any changes in the services offered by BMW Assist. If this occurs, you should update the services.

iDrive, for principle details, refer to page 16.

1. Press the **MENU** button to open the start menu.
2. Move the controller toward "BMW Assist".
3. Select "Status" and press the controller.
4. Select "BMW Assist" and press the controller.
5. Select "UPDATE" and press the controller.



The updating process takes a few minutes.

## Terminating services

When you terminate services, the connection to BMW Assist is deactivated.

iDrive, for principle details, refer to page 16.

1. Press the **MENU** button to open the start menu.
2. Move the controller toward "BMW Assist".
3. Select "Status" and press the controller.
4. Select "BMW Assist" and press the controller.
5. Select "DEACTIV." and press the controller.

BMW Assist is blocked from use, and your vehicle's current position will not be transmitted during an emergency call\*. To unblock the service, reactivate BMW Assist, see below. The contractual agreement is not affected by this.

Reactivate BMW Assist, if necessary, to log on again.

## Activating BMW Assist

BMW Assist services can only be used if BMW Assist is activated.

### Requirements

- ▷ Make sure that the vehicle can determine its current position. Reception is best when you have an unobstructed view of the sky.
- ▷ Leave ignition switched on while connecting to the system.

### Activating

iDrive, for principle details, refer to page 16.

1. Press the **MENU** button to open the start menu.
2. Move the controller toward "BMW Assist".
3. Select "Status" and press the controller.



4. Select "BMW Assist" and press the controller.



5. Select "INITIALIZE" and press the controller.

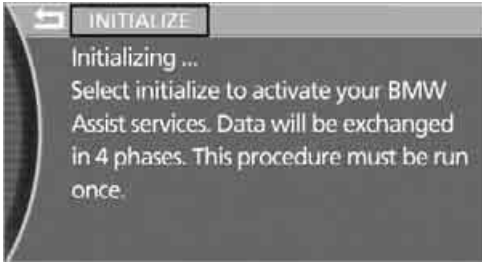

Activation takes a few minutes. The status appears on the Control Display. If you open another menu, the activation process continues to run in the background.

 During initialization, please do not turn off the system, i.e. leave the ignition switched on.

The services of BMW Assist can only be dialed up after initialization.

In order to assure the transmission of data, the initialization must be carried out while the vehicle is stationary. ◀

## Displaying vehicle data

When BMW Assist is activated, the license plate and the vehicle identification number of your vehicle can be displayed.

iDrive, for principle details, refer to page 16.

1. Press the **MENU** button to open the start menu.
2. Move the controller toward "BMW Assist".
3. Select "Status" and press the controller.

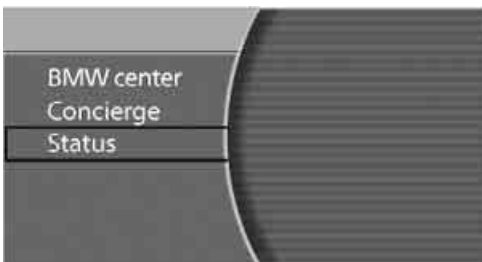

4. Select "Profile" and press the controller.







## Mobility

This section helps you maintain your mobility by supplying important information on vital topics including fuels and lubricants, wheels and tires, service, maintenance and Roadside Assistance.

# Refueling

**⚠** Switch off the engine before refueling; otherwise, no fuel can be dispensed into the tank and a message is displayed. ◀

**⚠** When handling fuel, take all applicable precautionary measures and follow all applicable regulations. Never transport reserve fuel containers in the vehicle. These can leak and cause an explosion or a fire in an accident. ◀

## Fuel filler door



To open and close: briefly press the rear edge of the fuel filler door.

### Manual release

In the event of a malfunction, you can release the fuel filler door manually:

1. Lift the handle to remove the cover panel on the right side of the luggage compartment.
2. Take the knob with the fuel pump symbol from the bracket and pull it to unlock the fuel filler door.

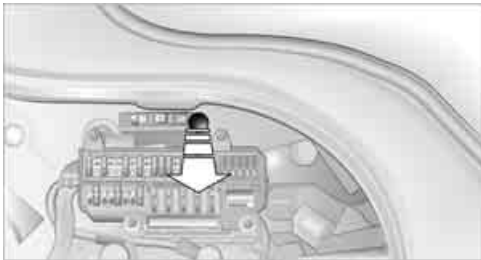

### Simple and environmentally friendly

**⚠** When handling fuels, always follow any safety guidelines posted at the gas station. ◀

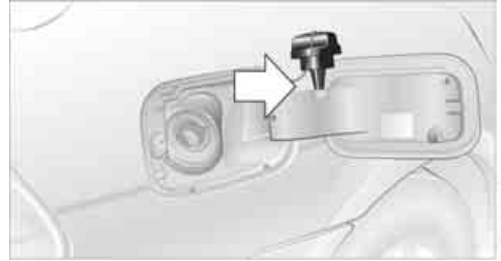

Put the filler cap in the bracket attached to the fuel filler door.

When refueling, insert the filler nozzle completely into the filler pipe. Avoid raising the filler nozzle during refueling; otherwise, this

- ▷ results in premature pump shutoff
- ▷ can lead to reduced efficiency in the fuel-vapor recovery system

The fuel tank is full when the filler nozzle clicks off the first time.

### Fuel tank capacity

Approx. 23.2 US gal/88 liters, including a reserve of:

- ▷ 750i/Li: approx. 2.6 US gal/10 liters.
- ▷ 760i/Li: approx. 3.1 US gal/12 liters.

**⚠** Refuel as soon as possible once your cruising range falls below 30 miles/ 50 km; otherwise, engine functions are not assured and damage can occur. ◀

### Closing fuel filler cap

Fit the cap and turn it clockwise until you clearly hear a click.

**⚠** Do not crush the cap leash between the fuel filler cap and the vehicle. A message\* is displayed if the cap is loose or missing. ◀



## Fuel specifications

 Do not use leaded gasoline; otherwise, you will damage the catalytic converter. Do not fill the tank with E85, i.e. fuel consisting of 85% ethanol or flex fuel. Otherwise the engine and fuel supply system will be damaged. ◀

### Required fuel

#### Super Premium Gasoline/AKI 91

This gasoline is highly recommended. However, you may also use gasoline with a lower AKI rating. The minimum AKI rating is 87. If you use gasoline with this minimum AKI rating, the engine may produce knocking sounds when starting at high outside temperatures. This has no effect on the engine life.

 Do not use any gasoline below the minimum specified fuel grade. Otherwise the engine could be damaged. ◀

#### Use high-quality brands

Field experience has indicated significant differences in fuel quality: volatility, composition, additives, etc., among gasolines offered for sale in the United States and Canada. Fuels containing up to and including 10% ethanol or other oxygenates with up to 2.8% oxygen by weight, that is, 15% MTBE or 3% methanol plus an equivalent amount of co-solvent, will not void the applicable warranties with respect to defects in materials or workmanship.

 The use of poor-quality fuels may result in drivability, starting and stalling problems, especially under certain environmental conditions such as high ambient temperature and high altitude.

Should you encounter driveability problems which you suspect could be related to the fuel you are using, we recommend that you respond by switching to a recognized high-quality brand such as gasoline that is advertised as Top Tier Detergent Gasoline.

Failure to comply with these recommendations may result in unscheduled maintenance. ◀

# Wheels and tires

## Tire inflation pressure

### Information for your safety

The condition of the tires and the maintenance of the specified tire pressure are crucial not only to the tire's service life, but also to driving comfort and most importantly, driving safety.

### Checking pressure

Only check tire inflation pressure when the tires are cold. This means after a maximum of 1,25 miles/2 km driving or when the vehicle has been parked for at least 2 hours. When tires are warm, the tire inflation pressure increases.

 Check the tire inflation pressure regularly and correct it as needed, including the spare wheel: at least twice a month and before starting long trips. If you fail to take this precaution, you may be driving on tires with incorrect tire pressures, a condition that can not only compromise your vehicle's driving stability, but also lead to tire damage and the risk of an accident. Do not drive with deflated, i.e. flat tires, except run-flat tires. A flat tire will seriously impair your vehicle's handling and braking response. Attempts to drive on a flat tire can lead to loss of control over the vehicle. ◀

 After correcting the tire inflation pressure, reinitialize the Flat Tire Monitor, refer to page 90, or reset the Tire Pressure Monitor, refer to page 92. ◀

### Pressure specifications

The tables below provide all the correct inflation pressures for the specified tire sizes at ambient temperature.

 The inflation pressures apply to the tire sizes and tire brands respectively approved and recommended by BMW; a list of these is available from your BMW center. ◀

For correct identification of the right inflation pressure for your tires, pay attention to the following:

- ▷ Tire sizes for your vehicle
- ▷ Load conditions
- ▷ Maximum allowable driving speed

### Tire inflation pressures for driving up to 100 mph/160 km/h

For normal driving up to 100 mph/160 km/h adjust pressures to the respective tire inflation pressures listed on the following pages in the column for traveling speeds up to a max. of 100 mph/160 km/h to achieve optimum driving comfort.

These pressure specifications can be found on the door post when you open the driver's door.





 The permissible top speed for these tire inflation pressures is 100 mph/160 km/h. Do not exceed this speed; otherwise, tire damage and accidents may result. ◀

### Tire inflation pressures for driving above 100 mph/160 km/h

 In order to drive at maximum speeds in excess of 100 mph/160 km/h, please consult the relevant table on the following pages and adjust tire pressures as necessary to the specified pressures for speeds exceeding 100 mph/150 km/h. Otherwise, tire damage and accidents could occur. ◀



Observe all national and local maximum speed limits; otherwise, violations of the law could occur.

## Tire inflation pressures for 750i/Li

Tire size	Pressure specifications in psi/kPa					
	Traveling speeds up to a max. of 100 mph / 160 km/h		All traveling speeds including those exceeding 100 mph/160 km/h			
All pressure specifications in the table are indicated in psi/kilopascal with cold tires. Cold = ambient temperature						
	245/55 R 17 102 H M+S	32/220	32/220	32/220	33/230	32/220
245/50 R 18 100 V M+S A/S						
245/50 R 18 100 W	32/220	35/240	32/220	36/250	35/240	42/290
245/50 R 18 100 H M+S						
245/50 R 18 104 V M+S XL						
Front: 245/45 R 19 98 W	32/220	-	32/220	-	33/230	-
Rear: 275/40 R 19 101 W	-	33/230	-	35/240	-	39/270
Front: 245/45 R 19 98 Y	32/220	-	32/220	-	32/220	
Rear: 275/40 R 19 101 Y	-	33/230	-	32/220		35/240
Front: 245/40 R 20 95 Y	32/220	-	32/220	-	33/230	-
Rear: 275/35 R 20 98 Y	-	36/250	-	35/240	-	39/270
Front: 245/35 ZR 21 96 Y XL	33/230	-	35/240	-	36/250	-
Rear: 285/30 ZR 21 100 Y XL	-	39/270	-	36/250	-	42/290

More details on the permissible load and weights can be found on page [228](#).

## Tire inflation pressures for 760i/Li

Tire size	Pressure specifications in psi/kPa					
	Traveling speeds up to a max. of 100 mph / 160 km/h		All traveling speeds including those exceeding 100 mph/160 km/h			
All pressure specifications in the table are indicated in psi/kilopascal with cold tires. Cold = ambient temperature			 			
	245/50 R 18 100 V M+S A/S	32/220	33/230	33/230	38/260	35/240
245/50 R 18 100 W	32/220	33/230	33/230	38/260	35/240	41/280
245/50 R 18 100 H M+S	32/220	33/230	33/230	38/260	35/240	41/280
245/50 R 18 104 V M+S XL	32/220	33/230	33/230	38/260	35/240	41/280
Front: 245/45 R 19 98 Y	32/220	-	32/220	-	33/230	-
Rear: 275/40 R 19 101 Y	-	32/220	-	32/220	-	33/230
Front: 245/40 R 20 95 Y	33/230	-	35/240	-	36/250	-
Rear: 275/35 R 20 98 Y	-	35/240	-	35/240	-	38/260
Front: 245/35 ZR 21 96 Y XL	38/260	-	39/270	-	41/280	-
Rear: 285/30 ZR 21 100 Y XL	-	38/260	-	39/270	-	41/280

More details on the permissible load and weights can be found on page [228](#).

## Tire coding

Knowledge of the labeling on the side of the tire makes it easier to identify and choose the right tires.

### Tire size

e.g. 245/50 R 18 100 V

Nominal width in mm ————|

Aspect ratio in % ————|

Radial tire code ————|

Rim diameter in inches ————|

Load rating, not for ZR tires ————|

Speed rating, before R on ZR tires ————|

### Speed rating

Q = up to 105 mph/160 km/h  
 T = up to 118 mph/190 km/h  
 H = up to 131 mph/210 km/h  
 V = up to 150 mph/240 km/h  
 W = up to 167 mph/270 km/h  
 Y = up to 186 mph/300 km/h

### Tire Identification Number

Tires with DOT codes meet the guidelines of the U.S. Department of Transportation.

DOT code:

e.g. DOT xxxx xxx 1007

Manufacturer code for tire makes ————|

Tire size and tire design ————|

Tire age ————|

### Tire age

The tire's date of manufacture is indicated on the sidewall:

DOT...1007 means that the tire was manufactured in the 10th week of 2007.

BMW recommends that you replace all tires – including the spare – after a maximum of

6 years, even though the tires may have a theoretical service life of up to 10 years.

### Uniform Tire Quality Grading

Quality grades can be found where applicable on the tire sidewall between tread shoulder and maximum section width. For example:

Tread wear 200 Traction AA

Temperature A

### DOT Quality Grades

Tread wear

Traction AA A B C

Temperature A B C



All passenger car tires must conform to Federal Safety Requirements in addition to these grades. ◀

### Tread wear

The tread wear grade is a comparative rating based on the wear rate of the tire when tested under controlled conditions on a specified government test course.

For example, a tire graded 150 would wear one and one-half, 1½, times as well on the government course as a tire graded 100. The relative performance of tires depends upon the actual conditions of their use, however, and may deviate significantly from the norm due to variations in driving habits, service practices and differences in road characteristics and climate.

### Traction

The traction grades, from highest to lowest, are AA, A, B, and C.

Those grades represent the tire's ability to stop on wet pavement as measured under controlled conditions on specified government test surfaces of asphalt and concrete. A tire marked C may have poor traction performance.



The traction grade assigned to this tire is based on straight-ahead braking traction tests, and does not include acceleration, cornering, hydroplaning, or peak traction characteristics. ◀

## Temperature

The temperature grades are A, B, and C, A being highest, and represent the tire's resistance to the generation of heat and its ability to dissipate heat when tested under controlled conditions on a specified indoor laboratory test wheel.

Sustained high temperature can cause the material of the tire to degenerate and reduce tire life, and excessive temperature can lead to sudden tire failure. The grade C corresponds to a level of performance which all passenger car tires must meet under the Federal Motor Vehicle Safety Standard No. 109. Grades B and A represent higher levels of performance on the laboratory test wheel than the minimum required by law.

 The temperature grade for this tire is established for a tire that is properly inflated and not overloaded. Excessive speed, underinflation, or excessive loading, either separately or in combination, can cause heat buildup and possible tire failure. ◀

## RSC Run-flat tires

You will recognize run-flat tires by a circular symbol containing the letters RSC on the side of the tire, refer to page 205.

## M+S

Winter and all-season tires. These have better winter properties than summer tires.

## XL

Indicates specially reinforced tires.

## Tire condition

Inspect your tires frequently for tread depth, signs of damage and for foreign objects lodged in the tread. Check the tread depth.

## Minimum tread depth

The tread depth should not fall below 0.12 in/ 3 mm, although, for example, European legislation only specifies a minimum tread depth of 0.063 in/1.6 mm.

At tread depths below 0.12 in/3 mm, there is an increased risk of high-speed hydroplaning, even when only small amounts of water are present on the road surface.

Winter tires display a noticeable loss in their ability to cope with cold-weather driving conditions once the tread wears to below 0.16 in/ 4 mm. To ensure continued safety, you should always have such tires replaced.

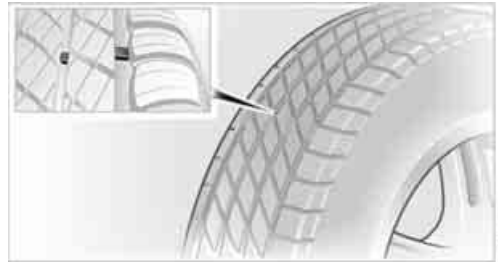

Wear indicators at the tread-groove base, refer to arrow, are distributed over the tire's circumference and are marked on the side of the tire with TWI – Tread Wear Indicator. If the tire tread has been driven down to the wear indicators, a tread depth of 0.063 in/1.6 mm has been reached.

## Wheel/tire damage

Please note that low profile tires make wheels, tires, and suspension parts more susceptible to road hazards and consequential damages. Unusual vibrations encountered during normal vehicle operation can indicate tire failure or some other vehicle defect. This can, for example, be caused by driving over curbs. These kinds of problems may also be signaled by other changes in vehicle response, such as a strong tendency to pull to the left or right.

 In these cases, reduce speed immediately and have wheels and tires thoroughly checked. Drive carefully to the nearest BMW center or tire shop that works according to BMW repair procedures with correspond-

ingly trained personnel. If necessary, have the vehicle towed there.

Tire damage can be extremely dangerous for vehicle occupants and other road users. ◀

## Run-flat tires\*



You will recognize run-flat tires by a circular symbol containing the letters RSC on the side of the tire.

The run-flat tires consist of special rims and tires that are self-supporting to a limited degree. The tire reinforcement ensures that the tire retains some residual safety in the event of pressure drop and driving remains possible to a restricted degree.

To continue driving with a damaged tire:

- ▶ When equipped with Flat Tire Monitor, refer to Indication of a flat tire on page 91.
- ▶ When equipped with Tire Pressure Monitor, refer to Low tire pressure message on page 93.

## New wheels and tires

 Only have new wheels and tires mounted by a BMW center or a tire specialist that works in accordance with BMW guidelines and uses appropriately trained personnel. If this work is not carried out properly, there is a danger of subsequent damage and related safety hazards. ◀

## Retreaded tires

 BMW does not recommend the use of retreaded tires; otherwise, driving safety may be reduced. Possible variations in the design and the age – which could be substantial – of the tire casing structures can lead to unusually rapid wear. ◀

## The right wheels and tires

 BMW recommends that you use only wheel and tire combinations that BMW has tested and approved for your particular vehicle. Variations in factors such as manufacturing tolerances mean that even wheels and tires with identical official size ratings could actually have different dimensions than the approved units – these differences could lead to body contact, and with it, the risk of severe accidents. If non-approved wheels and tires are used, BMW cannot evaluate their suitability, and therefore cannot be held liable for driving safety. ◀

You can ask your BMW center for the right wheel and tire combination.

The correct wheel and tire combination affects various systems whose function would otherwise be impaired, such as ABS or DSC.

To maintain good handling and vehicle response, use only tires of a single tread configuration from a single manufacturer. After a flat tire, always remember to have the original wheel and tire combination remounted on the vehicle as soon as possible.

## Wheels with electronics for TPM Tire Pressure Monitor\*

When mounting new tires or changing over from summer to winter tires, or vice versa, only use wheels with TPM electronics; otherwise the Tire Pressure Monitor may not be able to detect a flat tire, refer to page 91. Your BMW center will be glad to advise you.

## Recommended tire sizes and brands

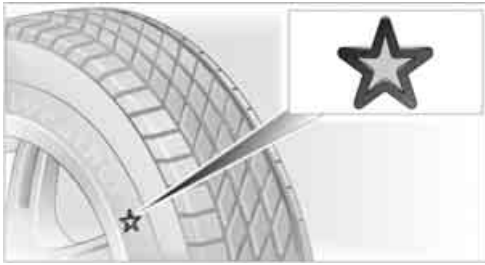

BMW recommends particular tire brands for each tire size. You will recognize them by the clearly visible BMW identification on the tire sidewall.

With proper use, these tires meet the highest standards for safety and handling characteristics.

### Run-flat tires

When installing new tires or when changing from summer tires to winter tires or vice versa, for your own safety, use run-flat tires. No spare wheel is provided in the event of a flat. Your BMW center will be glad to advise you.

 For safety reasons, BMW recommends that you not have damaged run-flat tires repaired; they should be replaced. ◀

### Special characteristics of winter tires

BMW recommends winter tires for use in cold winter driving conditions. Although so-called all-season M+S tires provide better winter traction than summer tires, they generally fail to provide the same levels of cold-weather performance as winter tires.

### Observing speed ratings

 Never exceed the maximum speed for which the winter tires are rated. ◀

## Storage

Always store wheels or tires in a cool, dry place with as little exposure to light as possible.

Always protect tires against all contact with oil, grease and fuels.

Do not exceed the maximum tire inflation pressure indicated on the side wall of the tire.

### Wheel changing between axles

BMW does not recommend changing the front wheels to the rear or vice versa as this can damage handling characteristics.

## Snow chains\*

Only certain fine-link snow chains are tested, classified as road-safe, and recommended by BMW. Consult your BMW center for more information. Use on winter tires is only permissible in pairs on the rear wheels. Follow the manufacturer's instructions when installing snow chains. Do not exceed 30 mph/50 km/h with the chains mounted.

 Do not initialize the Flat Tire Monitor after mounting snow chains. When you are driving with snow chains, it can be beneficial to activate DTC briefly, refer to page 88. ◀



# Under the hood

**!** Never attempt to perform any service or repair operations on your vehicle without the required, professional technical training. If you are unfamiliar with the regulations to be observed, only have work on your vehicle carried out by a BMW center or a repair shop that works in accordance with BMW guidelines and uses appropriately trained personnel. If this work is not carried out properly, there is a danger of subsequent damage and related safety hazards. ◀

## Hood

### Unlocking



Pull the lever located under the left side of the instrument panel.

### Opening

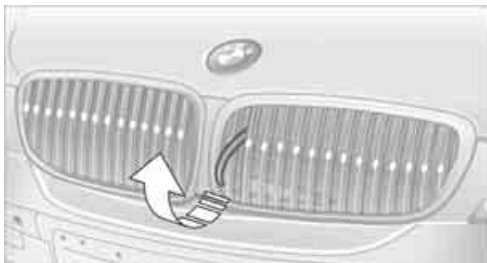

Pull the release handle and open the hood.

### Closing

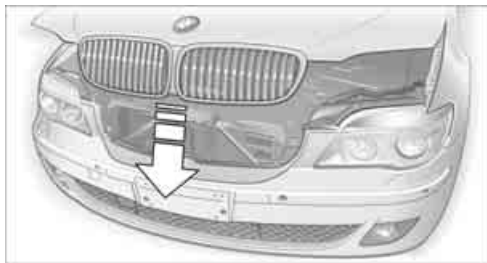

Close the hood with force. It must be clearly heard to engage.

**!** Take the same precautions that apply to all closing operations by ensuring that the hood's travel range is clear and unobstructed before allowing the hood to fall into position. If you see any signs that the hood is not completely closed while you are driving your vehicle, you should stop at once and close it securely. ◀

## Engine compartment

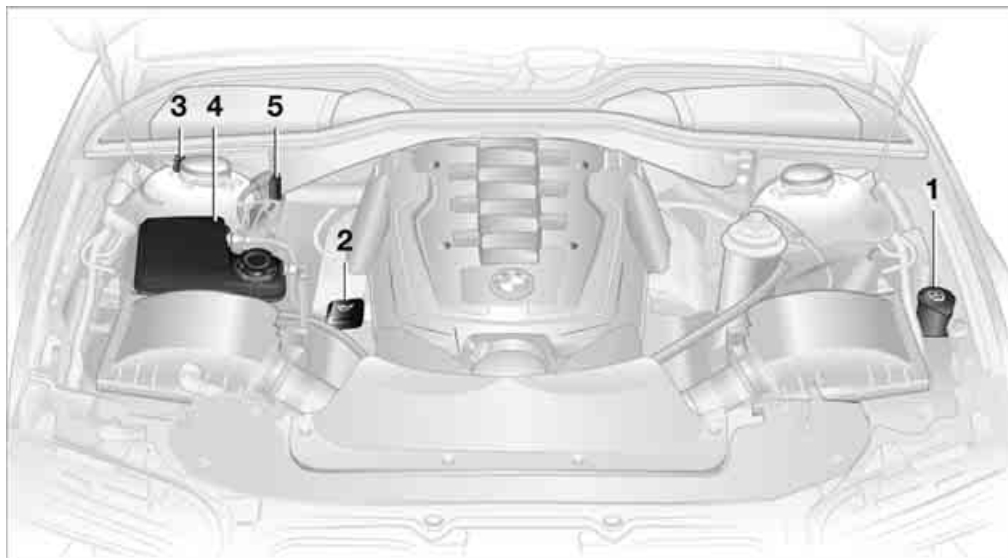

- |                                                                                                                 |                                                                                                                                                                     |
|-----------------------------------------------------------------------------------------------------------------|---------------------------------------------------------------------------------------------------------------------------------------------------------------------|
| <p>1 Wiper fluid filler neck <a href="#">66</a></p> <p>2 Engine oil filler neck, refer to Adding engine oil</p> | <p>3 Body ground, negative terminal <a href="#">220</a></p> <p>4 Coolant expansion tank <a href="#">210</a></p> <p>5 Jump starting terminal <a href="#">220</a></p> |
|-----------------------------------------------------------------------------------------------------------------|---------------------------------------------------------------------------------------------------------------------------------------------------------------------|

## Engine oil

The engine oil consumption depends on driving style and driving conditions.

### Checking oil level

Your vehicle is equipped with an electronic oil level control.

To obtain the most accurate possible oil level reading, the measurement should be taken when the engine is at operating temperature, i.e. following an uninterrupted drive of at least 6 miles/10 km. You can display the oil level while driving or when stopped on a level surface with the engine running.

The current oil level can be viewed on the Control Display.

iDrive, for principle details, refer to page [16](#).

1. Press the **MENU** button to open the start menu.
2. Move the controller toward "Car Data".
3. Select , and press the controller.

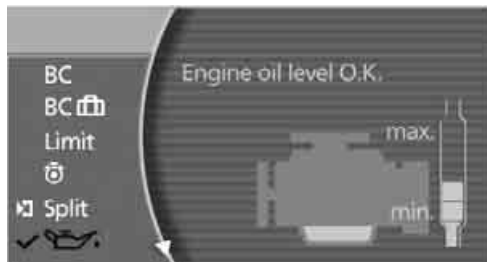

The oil level is displayed.

Turn the controller to exit the list.

## Possible displays

- ▷ "Update of engine oil level in process".
- ▷ "Engine oil level O.K."
- ▷ "Oil level at minimum! Add 1 quart engine oil": add a maximum of 1 quart/1 liter of engine oil at the earliest opportunity, refer to Adding engine oil.
- ▷ "Oil level under min.! Add 1 quart engine oil": add a maximum of 1 quart/1 liter of engine oil at the earliest opportunity, refer to Adding engine oil.
- ▷ "Engine oil level too high".
  - ⚠ Have vehicle checked immediately; otherwise, overfilled oil can lead to engine damage. ◀
- ▷ "No measurement possible at this time".

## Adding engine oil



Do not add oil until a Check Control message appears.

⚠ Add oil within the next 125 miles/200 km; otherwise, the engine could be damaged. ◀

⚠ Keep oil, grease, etc. out of reach of children and heed warnings on the containers to avoid health risks. ◀

## Oil changing

Only have an oil change carried out by a BMW center or a repair shop that works in accordance with BMW guidelines and uses appropriately trained personnel.

## Approved engine oils

The quality of the engine oil selected has critical significance for the operation and service life of an engine. BMW continuously approves specific engine oils after confirming their suitability for use in its vehicles with extensive testing.

Use only approved BMW High Performance Synthetic Oil.

If BMW High Performance Synthetic Oil is unavailable, you can add small quantities of other synthetic oils between oil changes. Use only oils of the specification API SH or higher.

▶ Your BMW center will be happy to answer detailed questions on BMW High Performance Synthetic Oil or approved synthetic oils. ◀

You can also call BMW of North America at 1-800-831-1117 or visit the website at [www.bmwusa.com](http://www.bmwusa.com) to obtain this information.

⚠ Never use oil additives as they can damage your engine under some circumstances. ◀

## Viscosity grades

The viscosity is a measure of the thickness of the oil and is specified in SAE grades.

The choice of the right SAE grade is based on the climatic conditions in the region in which you normally drive your BMW.

▶ Approved oils belong to the SAE grades 5W-40 and 5W-30. ◀

These oils can be used for driving at all outside temperatures.

BMW recommends 

## Coolant

 Do not open the cooling system when the engine is hot. Escaping coolant can cause burns. ◀

Coolant consists of water and supplemental antifreeze and anticorrosion agents. Not all commercially available additives are suitable for your BMW. Ask your BMW center for suitable additives.

 Only use suitable additives; otherwise, engine damage may result. The additives present a health hazard; follow the instructions on the containers. ◀

 Always follow all applicable environmental laws and regulations when disposing of used coolant additives. ◀

### Checking coolant level

1. Allow engine to cool.
2. Turn the cap of the expansion tank counterclockwise to allow any accumulated pressure to escape, then continue turning to open.
3. The coolant level is correct when the coolant extends to between the MIN and MAX marks on the filler neck, refer to the diagram adjacent to the filler neck.



4. If the coolant is low, slowly add coolant up to the specified level – do not overfill.
5. Twist closed the cap and tighten firmly.
6. Have the reason for the coolant loss eliminated as soon as possible.

# Maintenance

## BMW Maintenance System



The BMW Maintenance System serves to retain the operating and road safety of your BMW. The service schedule also includes operations related to the vehicle's comfort and convenience features, such as replacement of the filters for the inside air. The aim is to optimize maintenance procedures with a view to reducing the cost of running the vehicle.

Should the day come when you decide to sell your BMW, you will find that a complete dealer service history is an asset of inestimable value.

### CBS Condition Based Service

Sensors and special algorithms take the different driving conditions of your BMW into account. As a result, Condition Based Service determines the current and future maintenance requirements. By letting you define a service and maintenance regimen that reflects your own individual requirements, the system forms the basis for trouble-free driving.

On the Control Display, you can have the remaining times and distances for selected maintenance procedures and any legally mandated deadlines displayed, refer to page 78:

- ▷ Engine oil
- ▷ Brakes, separate for front and rear
- ▷ Microfilter
- ▷ Brake fluid
- ▷ Spark plugs

- ▷ Vehicle check
- ▷ Legally prescribed inspections depending on national regulations

### Service data in the remote control

Your vehicle continuously stores service-requirement information in the remote control while you are driving. After accessing the data stored in the vehicle key, your BMW Service Advisor can suggest precisely the right array of service procedures for your own individual vehicle. This is why it is important when you take your vehicle in for service to give the BMW Service Advisor the last remote control you used for driving.

 Storage periods with the battery disconnected are not taken into account by the CBS maintenance system. If this occurs, have a BMW center update the time-dependent maintenance procedures, such as checking brake fluid and if necessary engine oil and the micro/activated charcoal filter. ◀

### Service and Warranty Information Booklet for US models and Warranty and Service Guide Booklet for Canadian models

Please consult your Service and Warranty Information Booklet for US models and Warranty and Service Guide Booklet for Canadian models for additional information on service requirements.

 BMW recommends that you have service and repair operations performed at your BMW center.

Take the time to ensure that these service procedures are confirmed by entries in your vehicle's Service and Warranty Information Booklet for US models and Warranty and Service Guide Booklet for Canadian models. These entries verify that your vehicle has received the specified regular maintenance. ◀

## Socket for OBD Onboard Diagnostics



Components which are decisive for the exhaust-gas composition can be checked via the OBD socket with a device.

This socket is located to the left on the driver's side, on the underside of the instrument panel under a cover.

## Emissions values



The warning lamp lights up. The emissions values are deteriorating. Have the vehicle checked as soon as possible.



Display of the previously described malfunction on Canadian models.

Under certain circumstances, the warning lamp will flash. This is a sign of excessive misfiring of the engine. In this case you should reduce speed and drive to the nearest BMW center as soon as possible. Serious engine misfiring, even for only a short period of time, can seriously damage emission control components, especially the catalytic converter.



If the fuel filler cap is not properly tightened, the OBD system can detect the vapor leak and the indicator lamp will light up. If the cap is then tightened, the display should go out within a few days. ◀

## Event Data Recorders

Your vehicle may be equipped with one or several measuring and diagnosis modules, or with a device for recording or transmitting certain vehicle data or information. If you have also signed a contract of participation for BMW Assist, certain vehicle data can be transmitted or recorded to enable corresponding services.

## Care

You can find useful information on caring for your BMW in the Caring for your vehicle brochure.

# Replacing components

## Onboard tool kit



The onboard toolkit is located in the luggage compartment lid.

Loosen the wingnut to open.

The adapter for the spare key can be stored beneath the open-ended wrenches.

## Windshield wiper blades

To replace the blades, start by folding the wipers out and away from the windshield, refer to page 66.

## Lamps and bulbs

Lamps and lights contribute significantly to road safety. Therefore, comply fully with the following instructions during bulb replacement. BMW recommends that you entrust corresponding procedures to your BMW center if you are unfamiliar with them or they are not described here.

 Never touch the glass of new bulbs with your bare fingers, as even minute traces of contamination will burn into the bulb's surface and reduce its service life. Use a clean cloth, napkin, etc., or hold the bulb by its metal socket. ◀

You can obtain a selection of replacement bulbs at your BMW center.

 When working on the lighting system, you should always switch off the lights affected to prevent short circuits.

To avoid possible injury or equipment damage when replacing bulbs, follow any instructions provided by the bulb manufacturer. ◀

When maintaining the headlamps, please follow the instructions in the separate Caring for your vehicle brochure.

## Light-emitting diodes LEDs

Light-emitting diodes installed behind translucent lenses serve as the light source for many of the controls and displays in your vehicle. These light-emitting diodes, which operate using a concept similar to that applied in conventional lasers, are officially designated as Class 1 light-emitting diodes.

 Do not remove the covers, and never stare into the unfiltered light for several hours, as irritation of the retina could result. ◀

## Xenon lamp\*

The service life of these bulbs is very long and the probability of a failure is very low, provided that they are not switched on and off an unusual number of times. In the unlikely event that one of these lamps should fail, you can respond by switching on your fog lamps and proceeding carefully, where allowed by law.

 Only have work on the xenon lighting system including bulb changes carried out by a BMW center or a repair shop that works in accordance with BMW guidelines and uses appropriately trained personnel. Due to the high voltage involved, there is a danger to life and limb when work is carried out improperly. ◀

 For checking and adjusting headlamp aim, please contact your BMW center. ◀

## Turn signals, front

The illustration shows the left side of the engine compartment.

Two 21-watt bulbs: P21W or PY21W\*

1. Turn the bulb holder to the left and remove.
2. Apply gentle pressure to the bulb while turning it to the left for removal and replacement.

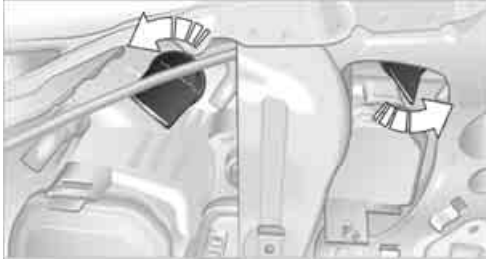

## Side-mounted turn signals

5-watt bulb, W5W

1. Press against the front edge of the lamp with the tip of your finger, then push it to the rear and release the detent at the front.

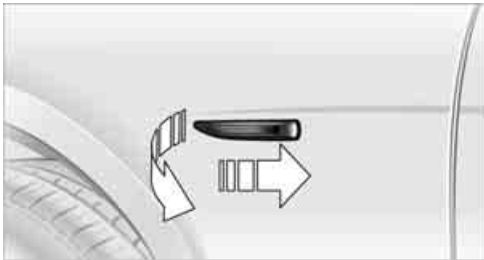

2. Turn the lamp by 90° and remove.
3. Turn the bulb holder to the left and remove.
4. Extract the bulb for replacement.

## Side marker lamps, front and rear

Please contact your BMW center for replacement.

## Tail lamps

- ▷ Turn signals: 21-watt bulb, P21W or PY21W\*
- ▷ Backup lamp: 16-watt bulb, W16W

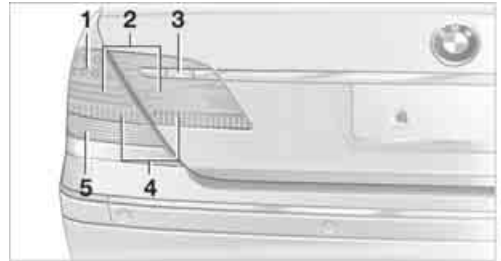

- 1 Brake lamp
- 2 Rear lamp
- 3 Backup lamp
- 4 Reflector
- 5 Turn signals

## Tail and brake lamps

These lights are made using LED technology. If a defect occurs, please contact your BMW center or a repair shop that works in accordance with BMW guidelines and uses appropriately trained personnel.

## Fender-mounted lamps

### Rear turn signals

The illustration shows the left part of the luggage compartment.

21-watt bulb, P21W or PY21W\*

1. Use the handle at the top to fold down the side trim panel.
2. Turn the bulb holder to the left and remove.



- Apply gentle pressure to the bulb while turning it to the left for removal and replacement.



### Lamps in luggage compartment lid



#### 1 Backup lamp

The illustration shows the left luggage compartment lid cutout.

Remove the trim panel from the luggage compartment lid.

### Backup lamp

16-watt bulb, W16W

- Pull the bulb holder out.
- Extract the bulb for replacement.

## Changing wheels

**⚠** Safety precautions to take in the event of a flat and during all tire changes:  
 Park the vehicle as far as possible from passing traffic. Park on a firm, flat, surface. Switch on the hazard warning flashers.  
 Engage the parking brake and shift the transmission selector lever into P.  
 Have all vehicle occupants get out of the vehicle and ensure that they remain outside the imme-

diated area in a safe place, such as behind a guardrail.  
 If a warning triangle\* or portable hazard warning lamp\* is required, set it up on the roadside at an appropriate distance from the rear of the vehicle. Comply with all safety guidelines and regulations.

Change the wheel only on a level, firm surface which is not slippery. The vehicle or the jack could slip to the side if you attempt to raise the vehicle on a soft or slippery surface such as snow, ice, tile, etc.

Position the jack on a firm support surface. Do not use a wooden block or similar object as a support base for the jack, as this would prevent it from extending to its full support height and reduce its load-carrying capacity.

To avoid serious or fatal injury, never lie under the vehicle and never start the engine while it is supported by the jack. ◀

### What you will need

To avoid rattling noises, note the positions of the tools before removing them, then return them to their initial positions after completing work.

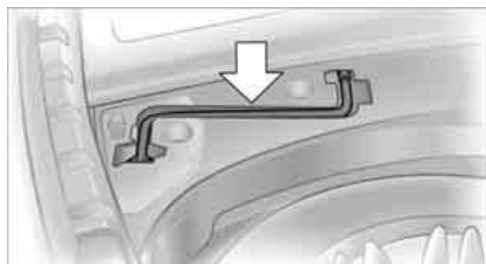

#### ▷ Lug wrench

Located beside the spare wheel.



## ▷ Wheel chock

Located next to the spare wheel, or behind the trim panel on the left side of the luggage compartment on vehicles equipped with a trailer coupling.

Remove the floor mat and the cover above the spare tire.

Unscrew the wingnut and remove the wheel chock.

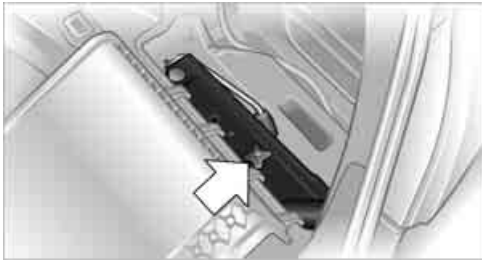

## ▷ Vehicle jack

Located in the luggage compartment behind the right-hand side panel.

Grasp the handle in the upper panel and fold it down.

Loosen the wingnut and remove the jack.

After use, screw the jack all the way back down and snap the handle back into place.

## Spare tire

1. Loosen the wing nut **1**.
2. Remove the washer **2** from the side.
3. Completely unscrew the threaded rod **3**.

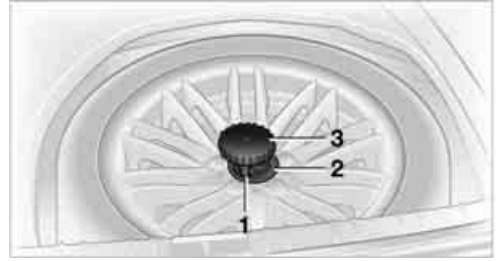

4. Remove the spare tire.

## Preparing for a wheel change

1. Read carefully and comply with the safety precautions on page [215](#).
2. Secure the vehicle to prevent it from rolling: Place the wheel chock against the rear surface of the front tire on the side opposite the side being raised. If the vehicle is parked on a downward slope, place the wheel chock securely in front of the tire. On a steep grade, take additional precautions to secure the vehicle against rolling.
3. Loosen the lug bolts a half turn.

## Lifting vehicle

1. Position the jack at the jacking point closest to the wheel so that the entire jack base makes contact vertically under the jacking point.



The vehicle jack is designed for changing wheels only. Do not attempt to raise another vehicle model with it or to raise any load of any kind. To do so could cause accidents and personal injury. ◀

2. Guide the jack head into the rectangular recess of the jacking point when cranking up the jack, refer to section of illustration.



3. Jack the vehicle up until the wheel you are changing is raised from the ground.

### Mounting a wheel

1. Unscrew the lug bolts and remove the wheel.
2. Remove accumulations of mud or dirt from the mounting surfaces of the wheel and hub. Clean the lug bolts.
3. Position the new wheel or spare tire on the hub and screw in at least two bolts diagonally.

When you mount wheels other than Genuine BMW light-alloy wheels, different lug bolts may also be required.

4. Screw in the remaining lug bolts. Tighten all the bolts securely in a diagonal pattern.
5. Lower the vehicle and remove the jack from beneath the vehicle.

### After mounting

1. Tighten the lug bolts in a diagonal pattern.



To ensure safety, always have the lug bolts checked with a calibrated torque wrench as soon as possible to ensure that they are tightened to the specified torque. The tightening torque is 100 lb ft/140 Nm. ◀

2. Reverse the removal sequence when storing the wheel and tools in the vehicle.

3. Check and correct the tire inflation pressure at the earliest opportunity.



Use valve stem seal caps to protect valve stems from dirt and contamination. Dirt in valve stems is a frequent source of gradual air loss. ◀

4. Reinitialize the Flat Tire Monitor, refer to page 90, or reset the Tire Pressure Monitor, refer to page 92.
5. Replace the damaged tire as soon as possible and have the new wheel/tire balanced.

### Driving with spare tire



On certain wheel-tire combinations, the size of the spare tire differs from that of the rest of the tires. The spare tire is fully capable of running in all load and speed ranges. However, to recreate the original conditions, the tire should be replaced as soon as possible. ◀

## Vehicle battery

### Maintenance

The battery is 100% maintenance-free, i.e., the electrolyte will last for the life of the battery when the vehicle is operated in a temperate climate. Your BMW center will be happy to advise you on all questions concerning the battery.

### Charging battery

Charge the battery in the vehicle only via the terminals in the engine compartment and with the engine off. Connections, refer to Jump starting on page 220.

## Battery switch

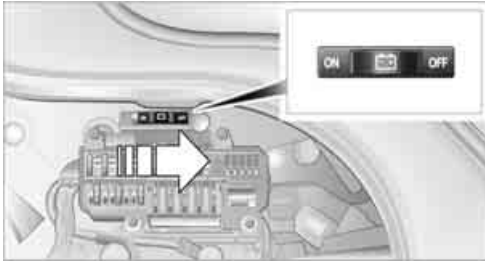

Before storing the vehicle for an extended period of several weeks or more, slide the battery switch located behind the trim panel on the right side of the luggage compartment to OFF. This reduces the current flow from the battery for the period during which the vehicle remains parked. A message appears on the Info Display. Please take note of the supplementary information provided on the Control Display.

## Disposal

 Have old batteries disposed of following replacement at your BMW center or bring them to a collection point. Maintain the battery in an upright position for transport and storage. Always secure the battery to prevent it from tipping over during transport. ◀

## Power failure

After a temporary interruption in electrical power, the functioning of some equipment may be limited and must be reinitialized. Individual settings are also lost and must be updated again:

- ▷ Seat, mirror, and steering wheel memory  
The positions must be stored again, refer to page 46.
- ▷ Time and date  
These must be reset, refer to page 84.
- ▷ Radio  
Stations must be stored again, refer to page 158.
- ▷ Navigation system  
You must wait until it becomes operational again, refer to Inserting navigation CDs/ DVDs on page 130.

## Fuses

 Never attempt to repair a blown fuse, and do not replace a defective fuse with a substitute of another color or amperage rating, as this could lead to a circuit overload, ultimately resulting in a fire in the vehicle. ◀

Spare fuses and plastic tweezers are stored in the fuse box in the luggage compartment.

## In glove compartment



Press the tab on the cover to the front, then fold down the cover.

Additional information about fuse allocations is provided on the fuse card in the compartment.

## In the luggage compartment

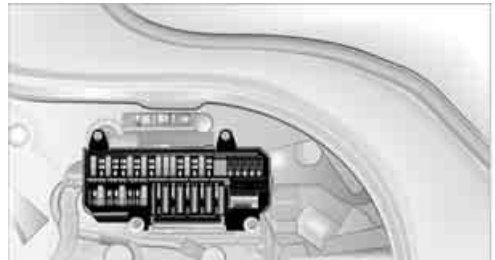

Pull the handle to fold down the trim on the right wall.

Additional information about fuse allocations is provided on the side panel.

# Giving and receiving assistance

## Emergency call\*

Conditions for an emergency call:

- ▶ Full preparation package mobile phone. This equipment package makes it possible to initiate an emergency call even if no mobile phone is paired with the vehicle.
- ▶ BMW Assist is activated. BMW Assist activation, refer to page 193.
- ▶ Radio ready state or ignition must be switched on.
- ▶ The BMW Assist system is logged on to a mobile phone network.
- ▶ The emergency call system is operable.

Once your service contract for BMW Assist expires, the BMW Assist system can be deactivated by a BMW center without you having to visit a workshop. Once the BMW Assist system has been deactivated, emergency calls are not possible. The BMW Assist system can be reactivated by a BMW center after a new contract has been signed.

### Initiating an emergency call

1. To open the protective cover: Briefly press the protective cover.
2. Press the emergency call button for at least 2 seconds.

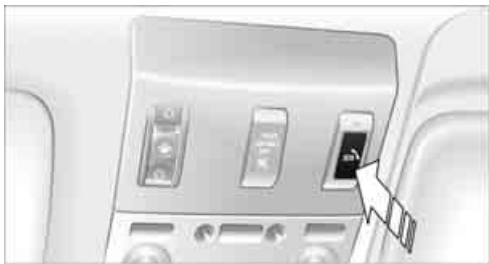

The LED in the button lights up. As soon as the voice connection to the BMW Assist response center has been established, the LED flashes.

Once the BMW Assist Response Center has received your emergency call, the BMW Assist Response Center contacts you and takes further steps to help you.

If circumstances permit, remain in the vehicle until the voice connection has been established. You will then be able to provide a detailed description of the situation.

If the current location of your vehicle can be determined, it will be transmitted to the BMW Assist Response Center.

If the LED is flashing but you cannot hear the BMW Assist Response Center over the hands-free system, then the hands-free system may be malfunctioning. You may, however, still be audible to the BMW Assist Response Center.

Under certain conditions, an emergency call is initiated automatically immediately after a severe accident. An automatic emergency call is not affected by the emergency call button being pressed.

 For technical reasons, the emergency call cannot be guaranteed under unfavorable conditions. ◀

 In order to transmit the vehicle location, a navigation CD/DVD must be inserted and the system must be currently receiving a GPS signal.

If the navigation system is inoperative, the current position of the vehicle is not transmitted. ◀

## Roadside Assistance\*

The BMW Group's Roadside Assistance service is there to assist you around the clock in the event of a breakdown, including on weekends and public holidays.

The phone numbers of the Roadside Assistance Center in your home country can be found in the Contact brochure.

Select "BMW Assist" if you have applied for this information service, refer to Roadside Assistance on page 190.

## Warning triangle\*



The warning triangle is conveniently stored in the onboard tool kit mounted on the inside of the luggage compartment lid.

## First-aid kit\*

The first-aid kit is also located in the container of the onboard tool kit.

Some of the articles contained in the first-aid kit have a limited service life. Check the expiration dates of the contents regularly and replace the contents concerned in a timely fashion as needed.

## Jump starting

When your battery is discharged, you can use two jumper cables to start your vehicle with power from the battery in a second vehicle. You can also use the same method to help start another vehicle. Use only jumper cables with fully-insulated terminal clamps.

**⚠** To avoid the risk of potentially fatal injury, always avoid all contact with electrical components while the engine is running. Carefully adhere to the following sequence, both to prevent damage to one or both vehicles, and to guard against possible personal injury. ◀

## Preparing

1. Check whether the battery of the other vehicle has a voltage of 12 Volts and approximately the same capacitance in Ah. This information is listed on the battery.
2. Switch off the engine of the assisting vehicle.
3. Switch off any electrical systems and components in both vehicles.

**⚠** Make sure that there is no contact between the bodywork of the two vehicles; otherwise, there is a danger of short circuits. ◀

## Connecting jumper cables

**⚠** To avoid personal injury from sparks, follow this sequence when connecting jumper cables. ◀

In your BMW, the so-called jump starting terminal in the engine compartment functions as the positive battery terminal. The symbol + is embossed on the cover.

1. Remove the cover of the BMW jump starting terminal, refer to arrow 1.
2. Attach one terminal clamp of the plus/+ jumper cable to the positive terminal of the battery or a jump starting terminal of the vehicle providing assistance.
3. Attach the second positive/+ clamp of the jumper cable to the positive battery terminal or to a jump starting terminal on the vehicle to be started.

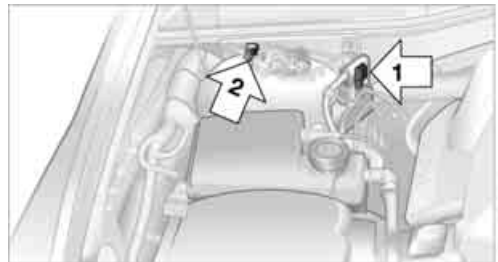

4. Attach one negative/- clamp of the jumper cable to the negative battery terminal or to an engine or body ground of the assisting vehicle.

Your BMW has a special nut that serves as a body ground or negative terminal, refer to arrow 2.

5. Attach the second negative/- clamp of the jumper cable to the negative battery terminal or to an engine or body ground on the vehicle to be started.

## Starting engine

1. Start the engine of the assisting vehicle and allow it to run for several minutes at a fast idle.
2. Start the engine on the other vehicle in the usual way.  
If the first start attempt is not successful, wait a few minutes before another attempt in order to allow the discharged battery to recharge.
3. Allow the engines to run for several minutes.
4. Disconnect the jumper cables again in the reverse sequence.

If need be, have the battery checked and recharged.

 Never use spray fluids to start the engine. ◀

## Towing and tow starting

 Observe applicable laws and regulations for tow starting and towing. ◀

 Do not transport any passengers other than the driver in a vehicle that is being towed. ◀

## Using tow fitting

The threaded tow fitting is stored in the onboard tool kit and must always remain in the vehicle. It can be screwed in at the front or rear of the BMW.

 Only use the tow fitting that comes with the vehicle and screw it in as far as it will go. Use the tow fitting for towing only on roads. Avoid lateral loading of the tow fitting, e.g. do

not lift the vehicle by the tow fitting. Otherwise, damage to the tow fitting and the vehicle can occur. ◀

## Access to screw thread

Press the arrow symbol to push out the cover.

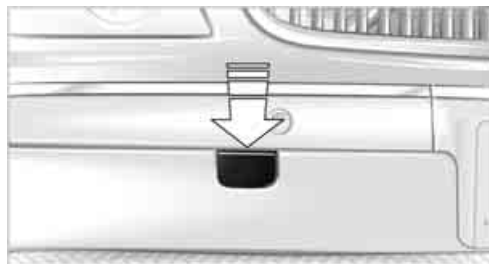

## Being towed

 Do not tow the vehicle by the rear axle; because there is no steering lock, the wheels could turn to an extreme angle during towing. There is no power assist with the engine stopped. This then requires increased effort for braking and steering. ◀

Switch on the hazard warning flashers depending on the local regulations. If the electrical system fails, mark the vehicle to be towed, e.g. with a sign or warning triangle in the rear window.

 Selector lever in position N. Releasing shiftlock manually, refer to page 64. To avoid damaging the automatic transmission, do not exceed a towing speed of 45 mph/70 km/h and a towing distance of 95 miles/150 km. ◀

## Towing methods

In some countries, towing with tow bars or ropes in public traffic is not permitted. Familiarize yourself with the regulations on towing in the respective country.

## With tow bar

 The towing vehicle must not be lighter than the vehicle to be towed; otherwise, it will no longer be possible to control vehicle response. ◀

The tow fittings used should be on the same side on both vehicles. Should it prove impossible to avoid mounting the tow bar at an offset angle, please be aware of the following:

- ▷ Clearance and maneuvering capability will be strictly limited in corners.
- ▷ When mounted at an angle, the tow bar will exert lateral forces, tending to push the vehicle sideways.

 Only secure the tow bar to the tow fitting; otherwise, damage can occur when it is secured to other parts of the vehicle. ◀

## With tow rope

When starting off in the towing vehicle, make sure that the towrope is taut.

 To avoid jerking and the associated stresses on vehicle components when towing, always use nylon ropes or nylon straps. Only secure the tow rope on the tow fitting; otherwise, damage can occur when it is secured on other parts of the vehicle. ◀

## With tow truck

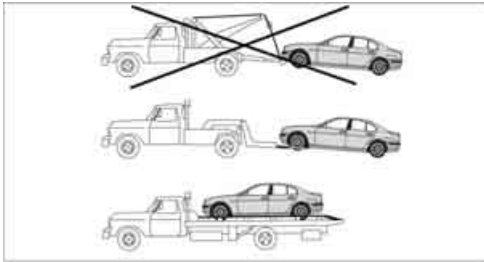

Have the BMW transported with a tow truck with a so-called lift bar or on a flat bed.

 Do not lift vehicle by tow fitting or body and chassis parts; otherwise, damage may result. ◀

## Tow starting

It is not possible to start the motor by tow starting.

Starting assistance, refer to page [220](#).

Have the cause of the starting difficulties remedied.







## Reference

This chapter contains the technical data, the short commands of the voice command system and the index, which is the quickest way to find the information you are looking for.

# Technical data

## Engine specifications

		750i/Li	760i/Li
Displacement	cu in/cm <sup>3</sup>	292.8/4,799	364.4/5,972
Number of cylinders		8	12
Maximum output at engine speed	hp rpm	360 6,300	438 6,000
Maximum torque at engine speed	lb ft/Nm rpm	360/488 3,400	444/600 3,950

## Dimensions

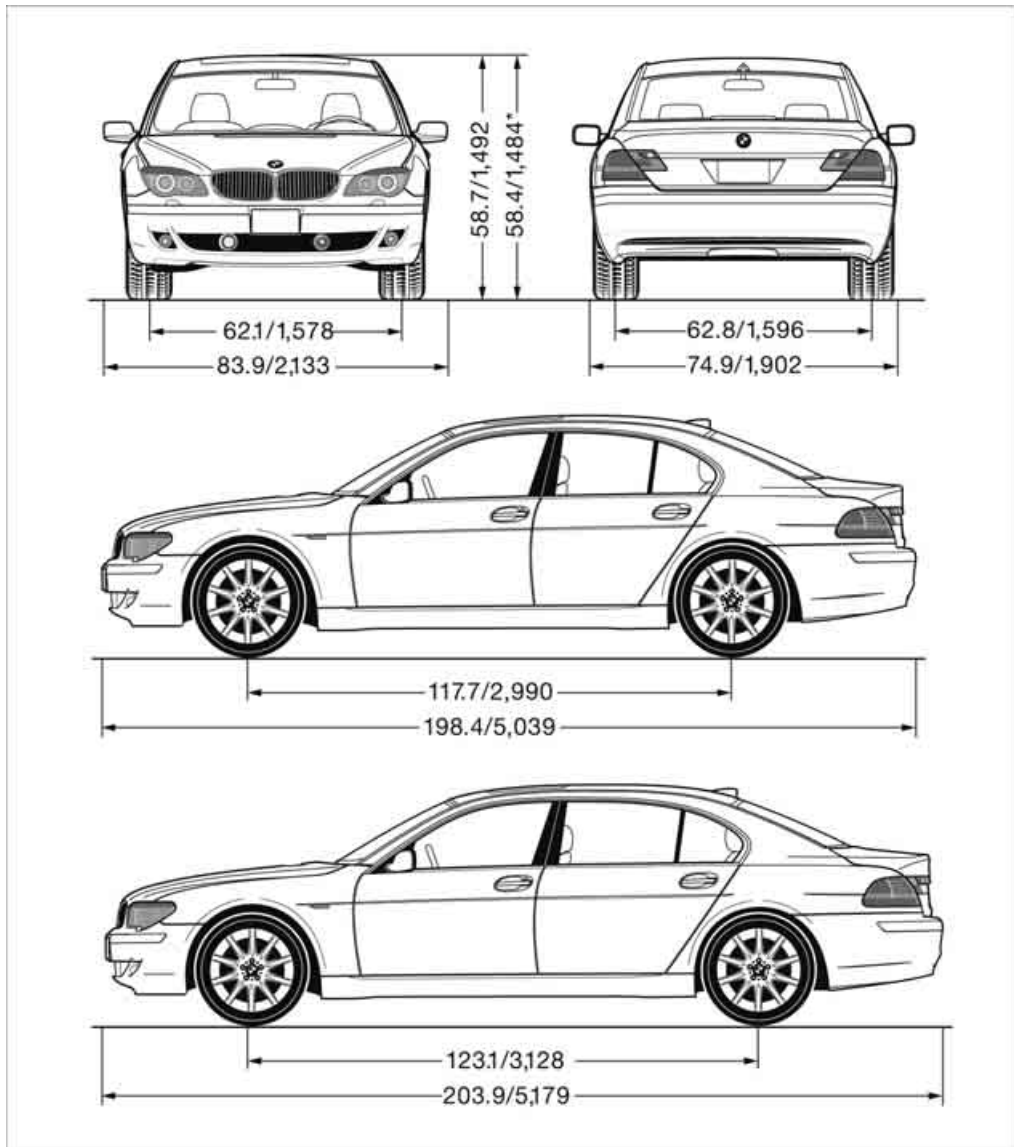

All dimensions given in inches/mm. Value marked with \* and lower side view: L models.  
 Min. turning circle diam.: 39.7 ft/12.1 m; L models: 41.3 ft/12.6 m.

## Weights

		750i	750Li
Curb weight	lbs./kg	4,486/2,035	4,452/2,065
Approved gross vehicle weight	lbs./kg	5,545/2,515	5,611/2,545
Load	lbs./kg	1,058/480	1,058/480
Approved front axle load	lbs./kg	2,579/1,170	2,602/1,180
Approved rear axle load	lbs./kg	3,075/1,395	3,108/1,410
Approved roof load capacity	lbs./kg	220/100	220/100
Luggage compartment capacity	cu ft/l	17.7/500	17.7/500

		760i	760Li
Curb weight	lbs./kg	4,762/2,160	4,905/2,225
Approved gross vehicle weight	lbs./kg	5,820/2,640	5,930/2,690
Load	lbs./kg	1,058/480	1,025/465
Approved front axle load	lbs./kg	2,778/1,260	2,833/1,285
Approved rear axle load	lbs./kg	3,109/1,410	3,109/1,410
Approved roof load capacity	lbs./kg	220/100	220/100
Luggage compartment capacity	cu ft/l	17.7/500	17.7/500

Never exceed either the approved axle loads or the gross vehicle weight.

# Capacities

Notes

Fuel tank including a reserve of:	US gal/liters	approx. 23.3/88	Fuel specification: page <a href="#">199</a>
750i/Li	US gal/liters	approx. 2.6/10	
760i/Li	US gal/liters	approx. 3.1/12	
Windshield and headlamp washer system	US quarts/liters	approx. 6.3/6.0	For details: page <a href="#">66</a>

At a glance

Controls

Driving tips

Navigation

Entertainment

Communications

Mobility

Reference

# Short commands of the voice command system\*

You can use short commands to execute certain functions directly, independent of which menu item is currently selected.

This listing contains important short commands of the voice command system.

## Notepad

Function	Command
To record a note <a href="#">25</a>	›Record note‹
To listen to notepad entry <a href="#">25</a>	›Read out note‹

## Navigation

Function	Command
To start route guidance <a href="#">144</a>	›Route guidance on‹
To display map view <a href="#">145</a>	›Map‹
To change scale <a href="#">145</a>	›Scale‹
To switch on the voice instructions <a href="#">146</a>	›Message on‹
To switch off the voice instructions <a href="#">146</a>	›Message off‹

## Entertainment

Function	Command
Entertainment sound output on/off <a href="#">153</a>	›Radio‹ or ›Audio off‹
To select FM waveband <a href="#">156</a>	›FM‹
To select AM waveband <a href="#">156</a>	›AM‹
To select frequency <a href="#">157</a>	›Frequency 88...107 (Point 1...9)‹
To call up a stored station, refer to Storing a station <a href="#">158</a>	›Station 1...12‹
To activate weather reports <a href="#">160</a>	›Weatherband‹
To call up weather reports <a href="#">160</a>	›Channel 1...7‹
To switch on satellite radio <a href="#">160</a>	›Turn on‹
Station selection <a href="#">160</a>	›Previous station‹ or ›Next station‹
Channel selection <a href="#">161</a>	›Previous channel‹ or ›Next channel‹ or ›Previous‹ or ›Next‹
To select a stored station <a href="#">161</a>	›Station 1...12‹
To start a CD <a href="#">163</a>	›CD on‹
To select a CD track <a href="#">163</a>	›Track 1...30‹
To start the CD changer <a href="#">165</a>	›CD changer‹



Function	Command
To select a CD <a href="#">166</a>	›CD 1...6‹
To start a DVD <a href="#">171</a>	›DVD on‹
To select a DVD <a href="#">171</a>	›DVD 1...6‹

## Communications

Function	Command
To dial from phone book <a href="#">185</a>	›Dial number‹
To redial <a href="#">185</a>	›Redial‹
To make a new entry in voice-command phone book <a href="#">186</a>	›Save name‹
To dial from voice-command phone book <a href="#">187</a>	›Dial name‹
To have voice-command phone book entries read aloud <a href="#">187</a>	›Read out‹

# Everything from A to Z

## Index

### A

- "ABC...", navigation [131](#)
- ABS Antilock Brake System [87](#)
- ACC, refer to Active cruise control [69](#)
- "ACCEPT", navigation [140](#), [148](#)
- Accessories, refer to Your individual vehicle [5](#)
- Accident, refer to
  - Initiating an emergency call [219](#)
  - Roadside Assistance [190](#), [219](#)
- Activated-charcoal filter [107](#)
- Activating
  - BMW Assist [193](#)
  - High Definition Radio [162](#)
- Active cruise control [69](#)
  - indicator lamp [71](#)
  - malfunction [72](#)
  - radar sensor [72](#)
  - sensor, refer to Malfunction [72](#)
- Active head restraints, front [47](#)
- Active seat [50](#)
- Active seat ventilation [50](#)
- Adapter for spare key [31](#)
- Adaptive brake lamp, refer to Brake force display [94](#)
- Adaptive Drive
  - refer to Dynamic Drive [89](#)
  - refer to EDC Electronic Damper Control [89](#)
- Adaptive Head Light [100](#)
- Address
  - deleting [140](#)
  - displaying [141](#)
  - storing [139](#)
  - storing current position [147](#)
- "Address book", navigation [139](#)
- Adjusting cooling action of rear climate control [108](#)
- Adjusting interior temperature [105](#)
- Adjusting tone in audio mode, refer to Tone control [153](#)
- Adjusting volume [153](#)
  - ring tone of telephone [179](#)
  - voice command system [25](#)
  - voice instructions [146](#)
- Airbags [95](#)
  - safe sitting position [43](#)
- Air conditioning [103](#)
  - in rear [108](#)
  - in the rear [108](#)
  - while parked [109](#)
- Air distribution
  - automatic [104](#)
  - manual [106](#)
- Airing, refer to Ventilation [107](#)
- Air jets, refer to Ventilation [107](#)
- Air pressure, refer to Tire inflation pressure [200](#)
- Air recirculation, refer to Recirculated-air mode [105](#)
- Air vents, refer to Ventilation [107](#)
- Air volume
  - automatic climate control [106](#)
  - rear climate control [108](#)
- AKI, refer to Fuel specifications [199](#)
- Alarm system [37](#)
  - avoiding unintentional alarms [38](#)
- All around the steering wheel [10](#)
- All-season tires, refer to Winter tires [206](#)
- Altering route, refer to Changing route [146](#)
- Alternate route, refer to Changing route [146](#)
- "AM", radio [156](#)
- AM, refer to Radio [156](#)
- "ANGLE", DVD changer [173](#)
- Antifreeze
  - coolant [210](#)
  - washer fluid [66](#)
- Antilock Brake System ABS [87](#)
- Anti-theft system
  - refer to Alarm system [37](#)
  - refer to Central locking system [32](#)
- Approved engine oils [209](#)
- Armrest, refer to Center armrest
  - front [113](#)
  - rear [114](#)
- "Arrow display", navigation [145](#)
- "AS ADDRESS", navigation [139](#), [147](#)
- Ashtray
  - front [115](#)
  - rear [116](#)
- Assist, refer to BMW Assist [189](#)
- Assistance getting in and out [52](#)
  - backrest width [44](#)
- Assistance systems, refer to Driving stability control systems [87](#)
- Assistance window [20](#)
- AUC Automatic recirculated-air control [105](#)

Audio 152  
– controls 152  
– switching on/off 153  
– tone control 153  
– volume 153  
"AUDIO", DVD changer 173  
Audio device, external 114  
Audio mode 152  
Automatic  
– air distribution 104  
– air volume 104  
– cruise control 67, 69  
– headlamp control 100  
– luggage compartment lid operation 33, 36  
– service notification 190  
– station storage 158  
– steering wheel adjustment, refer to Assistance getting in and out 52  
Automatic car wash, refer to Caring for your vehicle brochure  
Automatic climate control  
– adjusting temperature 105  
– AUTO program 104  
– defrosting windows and removing condensation 106  
– maximum cooling 106  
– rear climate control 108  
– rear refrigerator 117  
– residual heat 106  
– settings on Control Display 104  
– switching cooling function on and off manually 107  
– switching on and off 105  
Automatic closing of doors and luggage compartment lid, refer to Automatic Soft Close 35  
Automatic curb monitor 51  
Automatic garage door opener 111  
Automatic Hold 59  
– activation/deactivation 59  
– parking 60  
– programmable buttons 52

Automatic lighting  
– refer to Automatic headlamp control 100  
– refer to Daytime running lamps 100  
– refer to Interior lamps 101  
– refer to Pathway lighting 100  
Automatic recirculated-air control AUC 105  
Automatic soft closing  
– doors 35  
– luggage compartment lid 36  
Automatic station search 157  
Automatic transmission with Steptronic 62  
– buttons on steering wheel 63  
– interlock 62  
– manually unlocking and locking transmission lock 64  
– shiftlock 62  
– towing 221  
– tow starting 222  
"AUTO P"  
– activating/deactivating Automatic Hold 59  
– programmable buttons 52  
AUTO program, automatic climate control 104  
– adjusting intensity 104  
"Autostore list", radio 156  
"AUX", external audio device 169  
AUX-In  
– port 114  
– refer to External audio device 169  
"AUX level", external audio device 169  
Average fuel consumption 77  
– setting units 84  
Average speed 77  
– setting units 84  
"Avoid ferries", navigation 142  
"Avoid highway", navigation 142  
Avoiding unintentional alarms 38

"Avoid route", navigation 147  
"Avoid sect.", navigation 147  
"Avoid tolls", navigation 142  
Avoid tolls, navigation 142  
Axle loads, refer to Weights 228  
"A-Z", telephone 185

## B

Backrest contour, refer to Lumbar support adjustment 44  
Backrests, refer to Seat adjustment 44  
Backrest width adjustment, refer to Front comfort seat adjustment 44  
Backup lamp, replacing bulbs 215  
"Balance", balance and fader 154  
Bar, refer to Tow bar 221  
Bass, refer to Tone control 154  
"Bass", treble and bass 154  
Battery 217  
– jump starting 220  
– switch 218  
Battery charge, remote control in Comfort Access 39  
"BC", computer 77  
Belts, refer to Safety belts 48  
Beverage holder, refer to Cup holders 115  
Blower, refer to Air volume 106, 108  
"BLUETOOTH" 183  
Bluetooth link, activating/deactivating 183  
BMW Assist 189  
– activating 193  
– "BMW Assist" 193  
– "BMW center" 190  
– "Concierge" 192  
– info service 192  
– "Roadside Assistance" 190  
– services offered 189

BMW homepage [4](#)  
 BMW Maintenance System [211](#)  
 BMW Night Vision [97](#)  
 – activating/deactivating [98](#)  
 – cleaning camera [99](#)  
 – making settings [98](#)  
 Boot, refer to Luggage compartment [119](#)  
 Bottle holder, refer to Cup holders [115](#)  
 Brake assistant [87](#)  
 Brake force display [94](#)  
 Brake lamp, adaptive, refer to Brake force display [94](#)  
 Brake lamps  
 – brake force display [94](#)  
 – replacing bulbs [214](#)  
 Brake rotors, refer to Corrosion on brake rotors [123](#)  
 Brakes [123](#)  
 – ABS [87](#)  
 – brake force display [94](#)  
 – breaking-in [122](#)  
 – parking brake [58](#)  
 Brake system  
 – BMW Maintenance System [211](#)  
 – breaking-in [122](#)  
 – refer to Braking safely [123](#)  
 Breakdown service, refer to Roadside Assistance [190](#), [219](#)  
 Breaking-in [122](#)  
 Breaking-in differential, refer to Engine and differential [122](#)  
 "Brightness"  
 – BMW Night Vision [99](#)  
 – DVD changer [172](#)  
 – on Control Display [85](#)  
 Bulbs, replacing [213](#)  
 "button", programmable buttons [52](#)  
 Buttons  
 – next to the controller [16](#)  
 – on steering wheel [11](#)

**C**

"Calculate", refer to Bypassing route sections [147](#)  
 Calculating distance to destination [77](#)  
 California Proposition 65 Warning [6](#)  
 "CALL" [192](#)  
 Call  
 – accepting [184](#)  
 – automatically accepting, refer to Hands-free system [179](#)  
 – rejecting [184](#)  
 – touch tone dialing [180](#)  
 – while away, refer to Dialing numbers stored in a list [186](#)  
 Call back list, refer to Dialing a number from phone book or from numbers stored in a list [185](#)  
 Calling  
 – from phone book [185](#)  
 – from Top 8 list [186](#)  
 – redialing [185](#)  
 – with retracting telephone keypad [179](#)  
 Can holder, refer to Cup holders [115](#)  
 Capacities [229](#)  
 – luggage compartment [228](#)  
 Car battery, refer to Vehicle battery [217](#)  
 Car care, refer to Caring for your vehicle brochure  
 Car-care products, refer to Caring for your vehicle brochure  
 "Car Data" [79](#), [81](#)  
 Care, refer to Caring for your vehicle brochure  
 Caring for the upholstery, refer to Caring for your vehicle brochure  
 Caring for the vehicle finish, refer to Caring for your vehicle brochure  
 Car key, refer to Remote control/key [30](#)  
 Carpet care, refer to Caring for your vehicle brochure  
 Car radio, refer to Radio [156](#)  
 Car wash [123](#)  
 – also refer to Caring for your vehicle brochure  
 – with Comfort Access [39](#)  
 Catalytic converter, refer to Hot exhaust system [122](#)  
 "Categories", radio [161](#)  
 CBC Cornering Brake Control [87](#)  
 CBS Condition Based Service [211](#)  
 "CD", CD player [163](#)  
 "CDC", CD changer [166](#)  
 CD changer [165](#)  
 – compressed audio files [166](#)  
 – controls [152](#)  
 – fast forward, reverse [167](#)  
 – installation location [165](#)  
 – random sequence [167](#)  
 – sampling [167](#)  
 – selecting a CD [166](#)  
 – selecting track [166](#)  
 – starting [165](#)  
 – tone control [153](#)  
 – volume [153](#)  
 CD player [163](#)  
 – controls [152](#)  
 – fast forward, reverse [164](#)  
 – random sequence [164](#)  
 – sampling [163](#)  
 – selecting tracks [163](#)  
 – starting [163](#)  
 – tone control [153](#)  
 – volume [153](#)  
 Center armrest  
 – front [113](#)  
 – rear [114](#)  
 Center console, refer to Comfort features [14](#)  
 Central locking system [31](#)  
 – Comfort Access [38](#)  
 – from the inside [34](#)  
 "CHANGE", navigation [138](#)

- Changes, technical, refer to
  - For your own safety [5](#)
- Changing scale, map view in navigation [145](#)
- Changing settings on Control Display [84](#)
- Changing time display [84](#)
- Changing units of measure on Control Display [84](#)
- Changing wheels [215](#)
  - run-flat tires [205](#)
- "Channels", radio [160](#)
- Check Control [80](#)
  - "CHECK" [81](#)
  - CHECK button [81](#)
- Child's seats, refer to
  - Installing child restraint systems [54](#)
- Child restraint fixing system LATCH [55](#)
- Child restraint systems [54](#)
- Child-safety lock [56](#)
- Chrome parts, refer to Caring for your vehicle brochure
- Chrome-plated parts, care, refer to Caring for your vehicle brochure
- Cigarette lighter [116](#)
- "City / Postal Code", navigation [133](#)
- Cleaning, vehicle, refer to
  - Caring for your vehicle brochure
- Cleaning headlamps, tank capacity, refer to Wiper fluid filler neck [66](#)
- Cleaning windshield [65](#)
- "Climate"
  - activating activation time for parked car ventilation [110](#)
  - preselecting activation time for parked car ventilation [109](#)
  - rear climate control [108](#)
  - rear refrigerator [117](#)
  - switching parked car ventilation on and off directly [109](#)
- Climate comfort
  - windshield [126](#)
- Clock [75](#)
  - 12/24-hour mode [84](#)
  - also refer to Assistance window [21](#)
  - display format [84](#)
  - setting [84](#)
- "Clock", settings [84](#)
- Closing
  - from inside [34](#)
  - from outside [32](#)
- Clothes hooks [114](#)
- Cockpit [10](#)
- Cold start, refer to Starting engine [57](#)
- "Color", DVD changer [172](#)
- Combined instrument, refer to Info Display [12](#)
- "Comfort", EDC Electronic Damper Control [90](#)
- Comfort Access [38](#)
  - before driving into a car wash [39](#)
  - changing battery [39](#)
- Comfort features [14](#)
- Comfort program, EDC Electronic Damper Control [90](#)
- Comfort seat [44](#)
  - in rear [45](#)
- "Communication", phone [184](#)
- Compact Disc
  - refer to CD changer [165](#)
  - refer to CD player [163](#)
- Compartments, refer to
  - Storage compartments [113](#)
- Compressed audio files, CD changer [166](#)
- Computer [76](#)
  - displays on Control Display [77](#)
  - units of measure and display format [84](#)
- "Concierge", BMW Assist [192](#)
- Condensation, refer to When vehicle is parked [123](#)
- Condition Based Service CBS [211](#)
- Connecting car vacuum cleaner, refer to Power socket [116](#)
- Consumption, refer to
  - Average fuel consumption [77](#)
- Consumption statistics, refer to Average fuel consumption [77](#)
- "Continue route guidance?", navigation [144](#)
- "Contrast"
  - BMW Night Vision [98](#)
  - DVD changer [172](#)
- Control Center, refer to iDrive [16](#)
- Control Display
  - rear seat screen [21](#)
  - refer to iDrive [16](#)
  - setting brightness [85](#)
- Controller
  - programmable button [52](#)
  - rear seat screen [21](#)
  - refer to iDrive [16](#)
- Controls and displays [10, 14](#)
- Coolant [210](#)
  - level [210](#)
  - temperature [76](#)
- Cooler, refer to Rear refrigerator [117](#)
- Cooling
  - maximum [106, 108](#)
  - refer to AUTO program [104](#)
  - refer to Rear climate control [108](#)
  - refer to Rear refrigerator [117](#)
  - refer to Switching cooling function on and off manually [107](#)
- Copyright [2](#)
- Cornering Brake Control CBC [87](#)
- Cradle for mobile phone, refer to Using snap-in adapter [178](#)

Creating voice address book [141](#)  
 Cruise control [67](#), [69](#)  
 – refer to Active cruise control [69](#)  
 – refer to Programmable cruise control [67](#)  
 Cruising range [77](#)  
 Cup holders [115](#)  
 Curb weight, refer to Weights [228](#)  
 Current consumption, refer to Energy Control [77](#)  
 Currentness of Owner's Manual [5](#)  
 Current position  
 – displaying [147](#)  
 – storing [139](#)  
 Cursor for navigation, refer to Selecting destination via map [135](#)  
 "Curve mode", BMW Night Vision [98](#)  
 Customizing settings, refer to Key Memory [31](#)

## D

Dashboard, refer to Cockpit [10](#)  
 Data [226](#)  
 – dimensions [227](#)  
 – engine [226](#)  
 – filling capacities [229](#)  
 – weights [228](#)  
 Date, refer to Assistance window [20](#)  
 – display format [84](#)  
 – setting [84](#)  
 "Date", setting [84](#)  
 Daytime running lamps [100](#)  
 "DEACTIV.", BMW Assist [193](#)  
 Deactivating front passenger airbags [54](#)  
 Defroster, rear window [107](#)  
 Defrosting windows [106](#)  
 Defrosting windows and removing condensation [106](#)  
 Dehumidifying air, refer to Cooling function, switching on and off manually [107](#)  
 "DELETE", navigation [140](#)  
 Deleting address book [140](#)  
 Deleting entire list, refer to Deleting entries in lists [186](#)  
 Deleting entries in lists [186](#)  
 Destination for navigation [131](#)  
 – selecting using voice [141](#)  
 – selecting via information [135](#)  
 Destination list in navigation system, deleting [138](#)  
 "Dest. input", navigation [131](#)  
 "Dest. list", navigation [138](#)  
 Dialed numbers, refer to Redialing [185](#)  
 Diamond button [52](#)  
 Digital clock [75](#)  
 Dimensions [227](#)  
 Directional indicators, refer to Turn signals [65](#)  
 Direction announcements, refer to Route guidance by voice instructions [146](#)  
 Direction instructions, refer to Voice instructions [146](#)  
 Directory, refer to  
 – Address book [139](#)  
 – Phone book [186](#)  
 Displacement, refer to Engine specifications [226](#)  
 Display, refer to  
 – iDrive [16](#)  
 – Info Display [12](#)  
 Display illumination, refer to Instrument lighting [101](#)  
 Displaying track information, CD changer [167](#)  
 Display lighting, refer to Instrument lighting [101](#)  
 Display of malfunctions, refer to Check Control [80](#)  
 Disposal  
 – remote control battery [39](#)  
 – vehicle battery [218](#)  
 Distance to destination [77](#)  
 – refer to Remaining distance [77](#)  
 – units of measure [84](#)  
 Distance warning, refer to PDC Park Distance Control [86](#)  
 Door entry lighting, refer to Interior lamps [101](#)  
 Door key, refer to Remote control/key [30](#)  
 Door lock [34](#)  
 Doors  
 – unlocking and locking from inside [34](#)  
 – unlocking and locking from outside [32](#)  
 DOT Quality Grades [203](#)  
 Draft-free ventilation [107](#)  
 Driving lamps, refer to Parking lamps/low beams [100](#)  
 Driving notes [122](#)  
 Driving route, refer to Displaying route [145](#)  
 Driving stability control [87](#)  
 Driving tips, refer to Driving notes [122](#)  
 Dry air, refer to Cooling function [107](#)  
 DSC Dynamic Stability Control [87](#)  
 – indicator lamp [13](#)  
 "DTC" [88](#)  
 DTC Dynamic Traction Control [88](#)  
 – indicator lamp [13](#)  
 "DVD", DVD changer [171](#)

DVD changer [170](#)  
 – adjusting picture [172](#)  
 – adjusting volume [153](#)  
 – controls [152](#)  
 – country codes [171](#)  
 – DVD controller [171](#)  
 – fast forward [172](#)  
 – freeze frame [173](#)  
 – opening specific menu [174](#)  
 – playing DVD [171](#)  
 – reverse [172](#)  
 – searching for chapter [172](#)  
 – selecting language [173](#)  
 – selecting picture format [173](#)  
 – selecting subtitles [173](#)  
 – starting [171](#)  
 – tone control [153](#)  
 DVD multimedia changer,  
 refer to DVD changer [170](#)  
 Dynamic Drive [89](#)  
 Dynamic Stability Control  
 DSC [87](#)  
 – indicator lamp [13](#)  
 Dynamic Traction Control  
 DTC [88](#)  
 – indicator lamp [13](#)

## E

"EDC" [89](#)  
 EDC Electronic Damping  
 Control [89](#)  
 Eject button, refer to Buttons  
 on CD player [152](#)  
 Electrical malfunction  
 – door lock [34](#)  
 – driver's door [34](#)  
 – fuel filler door [198](#)  
 – glass sunroof, electric [42](#)  
 – luggage compartment lid [36](#)  
 – parking brake [60](#)  
 Electric steering wheel  
 adjustment [51](#)  
 Electronic brake-force  
 distribution [87](#)  
 Electronic Damping Control  
 EDC [89](#)

Electronic Stability Program  
 ESP, refer to DSC Dynamic  
 Stability Control [87](#)  
 Electronic toll collection  
 device, refer to Entry/pass  
 tags [126](#)  
 Emergency actuation, refer to  
 Manual operation  
 – door lock [34](#)  
 – driver's door [34](#)  
 – fuel filler door [198](#)  
 – glass sunroof [42](#)  
 – luggage compartment lid [36](#)  
 – parking brake [60](#)  
 – transmission lock for  
 automatic transmission with  
 Steptronic [64](#)  
 Emergency call [219](#)  
 Emergency release of luggage  
 compartment lid from inside  
 the luggage  
 compartment [37](#)  
 Emergency services, refer to  
 Roadside  
 Assistance [190, 219](#)  
 Energy-conscious driving,  
 refer to Energy Control/  
 current fuel consumption [77](#)  
 Energy Control [77](#)  
 Engine  
 – breaking-in [122](#)  
 – data [226](#)  
 – overheated, refer to Coolant  
 temperature [76](#)  
 – speed [75, 226](#)  
 – starting [57](#)  
 – switching off [58](#)  
 Engine compartment [208](#)  
 Engine coolant [210](#)  
 Engine oil  
 – additives, refer to Approved  
 engine oils [209](#)  
 – approved oils [209](#)  
 – checking oil level [208](#)  
 – electronic oil level check [208](#)  
 – oil types, also refer to  
 Approved engine oils [209](#)  
 – possible displays of oil level  
 check [209](#)

"Engine oil level O.K." [209](#)  
 "Engine oil level too high" [209](#)  
 Engine output, refer to Engine  
 specifications [226](#)  
 Engine overheating, refer to  
 Coolant temperature [76](#)  
 Engine speed [226](#)  
 "Enter", navigation [134](#)  
 Entering activation time of  
 parked car ventilation [109](#)  
 – "Time 1" [110](#)  
 – "Time 2" [110](#)  
 Entering destination  
 address [133](#)  
 Entering house number or  
 intersection, navigation [133](#)  
 Entering intersection,  
 navigation [133](#)  
 Entering name, destination in  
 navigation [132](#)  
 Entering street,  
 navigation [133](#)  
 "Entertainment", tone  
 control [153](#)  
 Entertainment sound output  
 on/off [153](#)  
 Entry/pass tags [126](#)  
 Entry for current position and  
 destination, refer to Entering  
 destination manually [131](#)  
 Environmentally friendly  
 driving, refer to Energy  
 Control [77](#)  
 Erasing entire list, refer to  
 Deleting entries in lists [186](#)  
 ESP Electronic Stability  
 Program, refer to DSC  
 Dynamic Stability  
 Control [87](#)  
 Event Data Recorders [212](#)  
 Exhaust system, refer to Hot  
 exhaust system [122](#)

- Exterior mirrors **50**
  - adjusting **50**
  - automatic dimming feature **51**
  - automatic heating **51**
  - folding in and out **51**
  - tilting down passenger-side mirror **51**
- External audio device **114, 169**
- "Extra"
  - rear air conditioner **108**
  - rear refrigerator **117**
- Eyes for lashing, refer to Securing cargo **125**

## F

- "Fader", balance and fader **154**
- Failure messages, refer to Check Control **80**
- Failure of an electrical device, refer to Fuses **218**
- False alarm, refer to Avoiding unintentional alarms **38**
- Fastening safety belts **48**
- "Fastest route", navigation **142**
- Fast forward
  - CD changer **167**
  - CD player **164**
  - DVD changer **172**
- Filter, refer to Microfilter/activated-charcoal filter **107**
- First-aid kit **220**
- Fittings for towing and tow starting **221**
- Flashlight, refer to Rechargeable flashlight **113**
- Flat tire
  - Flat Tire Monitor **90**
  - refer to Changing wheels **215**
  - refer to Tire condition **204**
  - run-flat tires **91, 93, 205**
  - spare tire **216**
  - Tire Pressure Monitor **91**

- Flat Tire Monitor **90**
  - initializing system **90**
  - show chains **206**
  - system limits **90**
  - warning lamp **91**
- Flooding, refer to Driving through water **123**
- Floor coverings, carpet, refer to Caring for your vehicle brochure
- Floor mat, refer to Caring for your vehicle brochure
- Fluid reservoir for washing systems, refer to Wiper fluid filler neck **66**
- "FM", radio **156**
- FM, refer to Radio **156**
- Fog lamps, refer to Front fog lamps **101**
- Following distance cruise control, refer to Active cruise control **69**
- Footbrake, refer to Braking safely **123**
- Footwell lamps, refer to Interior lamps **101**
- For specified oil grades, refer to Approved engine oils **209**
- Fresh air vents, refer to Ventilation **107**
- Front airbags **95**
- Front fog lamps, indicator lamp **11, 13**
- Fuel **199**
  - average fuel consumption **77**
  - gauge **76**
  - quality **199**
  - refer to Average fuel consumption **77**
  - reserve, refer to Fuel gauge **76**
  - tank capacity **229**

- Fuel consumption display, refer to
  - Average fuel consumption **77**
  - Displays on Info Display **76**
  - Energy control/current consumption **77**
- Fuel filler door **198**
  - manually unlocking **198**
- Fuel level, refer to Fuel gauge **76**
- Fuel-saving driving, refer to Energy Control **77**
- "Full", rear screen **22**
- "FULL MENU", DVD changer **173**
- "Full screen", BMW Night Vision **98**
- Fuses **218**

## G

- Garage door opener, refer to Integrated universal remote control **111**
- Gas
  - display, refer to Fuel gauge **76**
  - fuel quality **199**
- Gear changes, refer to Automatic transmission with Steptronic **62**
- Gear display, refer to Displays on Info Display **62**
- "General destination", navigation **136**
- General driving notes **122**
- Glasses compartment **115**
- Glass sunroof, electric **41**
  - convenience operation **32**
  - moving manually **42**
- Glove compartment **113**
- Grilles, refer to Ventilation **107**
- Gross weight, refer to Weights **228**



## H

- Handbrake, refer to Parking brake [58](#)
- Automatic Hold [59](#)
- manual operation [58](#)
- Hands-free system [179](#)
- Hazard warning flashers [15](#)
- "HD", High Definition Radio [162](#)
- Head airbags [95](#)
- Headlamp control, automatic [100](#)
- Headlamp flasher [65](#)
- indicator lamp [13](#)
- Headlamps [100](#)
- care, refer to Caring for your vehicle brochure
- cleaning, refer to Wiper system [65](#)
- replacing bulbs [213](#)
- Head light, refer to Adaptive Head Light [100](#)
- Headphones [22](#)
- Head restraints [46](#)
- front head restraints, active [47](#)
- installation, front [47](#)
- removal, front [46](#)
- sitting safely [43](#)
- Heating [103](#)
- exterior mirrors [51](#)
- mirrors [51](#)
- rear window, refer to Rear window defroster [107](#)
- residual heat [106](#)
- seats [49](#)
- steering wheel [52](#)
- when parked, refer to Residual heat [106](#)
- windshield, refer to Defrosting windows and removing condensation [106](#)
- windshield washer nozzles [66](#)
- Heating and ventilation [103](#)

- Heavy cargo, refer to Stowing cargo [124](#)
- Height, refer to Dimensions [227](#)
- Height adjustment
- seats [44](#)
- steering wheel [51](#)
- "Help"
- assistance window [21](#)
- menu guidance [19](#)
- "Help text", assistance window [21](#)
- Help text on Control Display [21](#)
- "Hide map icons", navigation [137](#)
- "high", automatic climate control [105](#)
- High beams [101](#)
- headlamp flasher [101](#)
- indicator lamp [11](#)
- High Definition Radio [162](#)
- Hills [123](#)
- Holder for cups [115](#)
- Home address
- selecting [141](#)
- storing [140](#)
- Hood [207](#)
- Horn [11](#)
- Hotel function, refer to Locking separately [35](#)
- Hot exhaust system [122](#)
- Hour signal activation [85](#)
- "House number", navigation [134](#)
- Hydraulic brake assistant, refer to Brake assistant [87](#)
- Hydroplaning [123](#)

## I

- ID3 tag, refer to Displaying track information [167](#)
- iDrive [16](#)
- assistance window [20](#)
- automatic climate control [104](#)
- changing date and time [84](#)
- changing language [84](#)
- changing settings [84](#)
- changing units of measure and display format [84](#)
- confirming selection or entry [19](#)
- controller [16](#)
- controls [16](#)
- displays, menus [17](#)
- menus [17](#)
- rear seat screen [21](#)
- selecting menu item [19](#)
- setting brightness [85](#)
- showing help text [21](#)
- start menu [18](#)
- status lines [20](#)
- symbols [19](#)
- Ignition key [30](#)
- Ignition lock [57](#)
- Illuminated vanity mirror [51](#)
- Imitation leather, refer to Caring for your vehicle brochure
- "Indep. ventil.", automatic climate control [109](#)
- Indicator/warning lamps [13](#)
- airbags [96](#)
- alarm system [37](#)
- DSC [88](#)
- DTC [88](#)
- Flat Tire Monitor [91](#)
- fog lamps [101](#)
- safety belt warning [48](#)
- Tire Pressure Monitor [93](#)
- Individually programmable buttons [11](#), [52](#)
- Individual settings, refer to Key Memory [31](#)

Inflation pressure, refer to Tire inflation pressure **200**  
 Inflation pressure monitoring  
 – refer to Flat Tire Monitor **90**  
 – refer to Tire Pressure Monitor **91**  
 Info Display **12**  
 "Information", navigation **136**  
 Information, navigation  
 – "On country" **135**  
 – "On dest." **135**  
 – "On location" **135**  
 – "On town/city" **135**  
 Info service **192**  
 Infrared windshield, refer to Entry/pass tags **126**  
 "INITIALIZE", BMW Assist **194**  
 Inserting navigation CD/DVD **130**  
 Installation location  
 – CD changer **165**  
 – DVD changer **170**  
 – mobile phone, refer to Inserting mobile phone **181**  
 – navigation drive **130**  
 Instructions, navigation system, refer to Route guidance by voice instructions **146**  
 Instrument cluster, refer to Info Display **12**  
 Instrument lighting **101**  
 Instrument panel, refer to Cockpit  
 – all around the steering wheel **10**  
 – comfort features **14**  
 Integrated universal remote control **111**  
 Interior lamps **101**  
 – switching on with remote control **32**  
 Interior motion sensor **38**  
 – switching off **38**  
 Interior rearview mirror, automatic dimming feature **51**

Interlock, refer to Switching off engine **58**  
 "INTERM. TIME", stopwatch **83**  
 Interval Display, refer to Service requirements **78**

## J

Joystick, refer to iDrive **16**  
 Jump starting **220**

## K

Keyless-Go, refer to Comfort Access **38**  
 Keyless opening and closing, refer to Comfort Access **38**  
 Key Memory **31**  
 Keys **30**  
 – adapter for spare key **30**  
 – key-related settings, refer to Key Memory **31**  
 Kick-down **63**  
 Knock control **199**

## L

Lamps and bulbs **213**  
 "Language", settings **84**  
 Lashing eyes, refer to Securing cargo **125**  
 "Last", phone **186**  
 "Last dest.", navigation **137**  
 Last destination driven to, refer to Destination list **138**  
 Last numbers on mobile phone, refer to Dialing numbers stored in a list **186**  
 LATCH child restraint fixing system **55**  
 Leather care, refer to Caring for your vehicle brochure  
 LEDs light-emitting diodes **213**  
 "Left", seat heating **49**  
 Length, refer to Dimensions **227**

Level control system **89**  
 Light, refer to Parking lamps/low beams **100**  
 Light alloy wheels, care and maintenance, refer to Caring for your vehicle brochure  
 Light-emitting diodes LEDs **213**  
 Lighter **116**  
 Lighter socket, refer to Power socket **116**  
 Lighting  
 – of instruments **101**  
 – of vehicle **100**  
 Light switch **100**  
 "Limit" **82**  
 Limit, refer to Speed limit **82**  
 "Limited", rear screen **22**  
 Load, refer to Loading **124**  
 Loading  
 – securing cargo **125**  
 – vehicle **124**  
 "LOC.", navigation **140**  
 "Location", navigation **139, 147, 148**  
 Lock buttons in the doors, refer to Locking **34**  
 Locking  
 – from inside **34**  
 – from outside **32**  
 Locking without key, refer to Comfort Access **38**  
 Locking without remote control, refer to Comfort Access **38**  
 "LOGIC7", tone control **154**  
 Longlife oils, approved oils **209**  
 "low", automatic climate control **105**  
 Low beams **100**  
 – automatic **100**  
 – replacing bulbs, refer to Xenon light **213**  
 Lower back support, refer to Lumbar support adjustment **44**

Lug bolts  
 – refer to Preparing for a wheel change 216  
 – tightening torque, refer to After mounting 217  
 – wrench, refer to What you will need 215

Luggage compartment 119  
 – capacity 228  
 – convenient access 39  
 – locking separately 35  
 – net 119  
 – opening/closing, refer to Luggage compartment lid 35  
 – opening from inside 36  
 – opening from outside 35  
 – opening with remote control 33  
 – refer to Luggage compartment lid 35

Luggage compartment lid  
 – automatic operation 33, 36  
 – Comfort Access 39  
 – emergency actuation, refer to Manual operation 36  
 – emergency release 37  
 – locking separately 35  
 – opening from inside 36  
 – opening from outside 35  
 – opening separately 35  
 – opening with remote control 33  
 – remote control 33  
 – unlocking manually, refer to Opening separately 35

Luggage rack, refer to Roof-mounted luggage rack 125

Lumbar support adjustment 44

## M

M+S tires, refer to Winter tires 206

Maintenance 211  
 – refer to Service required 78

Maintenance System 211

Make-up mirror, refer to Illuminated vanity mirror 51

Malfunction  
 – door lock 34  
 – fuel filler door 198  
 – glass sunroof 42  
 – luggage compartment lid 37

Malfunction displays, refer to Check Control 80

"MANUAL", radio 157, 159, 162

Manually unlocking and locking the transmission lock 64

Manual operation  
 – door lock 34  
 – driver's door 34  
 – fuel filler door 198  
 – glass sunroof 42  
 – luggage compartment lid 36  
 – parking brake 60  
 – transmission lock for automatic transmission with Steptronic 64

Manual station scan 157

Map CD, refer to Navigation CD/DVD 130

"Map dir. travel", navigation 145

"Map facing N.", navigation 145

Map for navigation  
 – changing scale 24, 145  
 – destination entry 135

Map view facing north 145

Master key, refer to Remote control/key 30

Maximum cooling 106, 108

"medium", automatic climate control 105

"Memo", hour signal 85

Memory, refer to  
 – Key Memory 31  
 – Seat, mirror and steering wheel memory 46

"MENU", DVD changer 174

"menu", rear screen 22

"Menu name" 19

Menus, Control Display 17

Microfilter, automatic climate control 107

Microphone for voice command 179

Mirror dimming feature 51

Mirrors 50  
 – automatic curb monitor 51  
 – folding in and out 51  
 – heating 51  
 – memory, refer to Seat, mirror and steering wheel memory 46

"Missed", phone 186

Missed calls, refer to Dialing numbers stored in a list 186

Mobile phone  
 – changing from hands-free system to mobile phone 187  
 – changing from mobile phone to hands-free system 187  
 – dialing a number from Top 8 list 186  
 – hands-free system 179  
 – initiating an emergency call 219  
 – inserting 181  
 – inserting phone cradle 181  
 – missed calls 186  
 – operating 181  
 – operating via retracting telephone keypad 179  
 – operating with buttons on steering wheel 11  
 – overview 178  
 – pairing with vehicle 182  
 – phone book 185  
 – redialing 185  
 – refer to Telephone overview 178  
 – removing 182  
 – removing phone cradle 181  
 – snap-in adapter 178  
 – unpairing from vehicle 183  
 – volume adjustment 179

Modifications, technical, refer to For your own safety 5

Monitor, refer to  
 – iDrive 16  
 – rear seat screen 21

Mounting for vehicle jack,  
refer to Lifting vehicle [216](#)

MP3, refer to Compressed  
audio files [166](#)

Multi-function steering wheel,  
refer to Buttons on steering  
wheel [11](#)

Multifunction switch

– refer to Turn signals/  
headlamp flasher [65](#)

– refer to Wiper/washer  
system [65](#)

## N

"Name", navigation [132](#)

"Navigation" [130](#), [144](#)

Navigation announcements,  
refer to Switching voice  
instructions on/off [146](#)

Navigation destination

– manual entry [131](#)

– selecting via map [135](#)

Navigation drive, installation  
location [130](#)

Navigation system [130](#)

– address book [139](#)

– adjusting volume [25](#), [146](#)

– changing route [146](#)

– current position [147](#)

– destination input [131](#)

– destination list [138](#)

– displaying route [145](#)

– manually entering  
destination address [131](#)

– navigation CD/DVD [130](#)

– recent destinations [137](#)

– route guidance in assistance  
window [130](#)

– route list [146](#)

– selecting destination via  
information [135](#)

– selecting destination via  
map [135](#)

– selecting route criteria [141](#)

– starting route guidance [144](#)

– terminating/continuing route  
guidance [144](#)

– voice instructions [146](#)

"Navi info", programmable  
buttons [52](#)

Neck supports, refer to Head  
restraints [46](#)

Nets, refer to Securing  
cargo [125](#)

"New dest.",  
navigation [131](#), [135](#)

"New information", BMW  
Assist [192](#)

New remote control, for  
vehicle [30](#)

"New route",  
navigation [142](#), [146](#)

"Next", navigation [135](#)

Night vision device, refer to  
BMW Night Vision [97](#)

"No measurement possible at  
this time", checking engine  
oil level [209](#)

"None", rear screen [22](#)

Non-smokers' equipment  
package, refer to Power  
socket [116](#)

Notepad of voice command  
system [25](#)

Nozzles, refer to

Ventilation [107](#)

Number of cylinders, refer to  
Engine specifications [226](#)

Nylon rope, refer to Towing  
and tow starting [221](#)

## O

OBD socket [212](#)

Octane numbers, refer to Fuel  
specifications [199](#)

Odometer [75](#)

Oil

– additives, refer to Approved  
engine oils [209](#)

– approved engine oils [209](#)

– consumption, refer to  
Engine oil, checking [208](#)

– level [208](#)

– topping up, refer to Adding  
engine oil [209](#)

– viscosity ratings [209](#)

Oil change interval, refer to  
Service requirements [78](#)

Oil consumption, refer to  
Checking engine oil [208](#)

"Oil level at minimum! Add  
1 quart engine oil", checking  
engine oil level [209](#)

"Oil level under min.! Add  
1 quart engine oil", checking  
engine oil level [209](#)

"OK", DVD changer [174](#)

"ON / OFF", speed limit [82](#)

Onboard computer, refer to  
iDrive [16](#)

Onboard tool kit [213](#)

"On country", navigation [136](#)

"On dest.", navigation [136](#)

Online help, refer to Roadside  
Assistance [190](#)

"On location", navigation [136](#)

"On town/city",  
navigation [136](#)

Opening and closing

– from inside [34](#)

– from outside [32](#)

– via door lock [34](#)

– with remote control [32](#)

Oral note [25](#)

Orientation menu, refer to  
Opening start menu [18](#)

Outlet slits, refer to  
Ventilation [107](#)

Outside air, refer to Automatic  
recirculated-air control  
AUC/recirculated-air  
mode [105](#)

Outside temperature  
display [75](#)

– changing units of  
measure [84](#)

Overview

– all around the steering  
wheel [10](#)

– comfort area [14](#)

– iDrive [16](#)

– radio control [152](#)

## P

- "PAIRING", phone [182](#)
- Panic mode [33](#)
- Park Distance Control PDC [86](#)
- "Parked car", parked car ventilation [109](#)
- Parked car ventilation [109](#)
  - activating activation time [110](#)
  - preselecting activation time [109](#)
  - switching on and off directly [109](#)
- Parking, vehicle [58](#)
- Parking aid, refer to PDC Park Distance Control [86](#)
- Parking assistant, refer to PDC Park Distance Control [86](#)
- Parking brake [58](#)
  - Automatic Hold [59](#)
- Parking lamps [100](#)
- Parking lamps/low beams [100](#)
- Parking with Automatic Hold [60](#)
- Park lock, refer to Parking [62](#)
- Partial distance odometer, refer to Trip odometer [75](#)
- Parts and accessories, refer to Your individual vehicle [5](#)
- Passenger airbag status lamp [96](#)
- Passenger-side exterior mirror, tilting down [51](#)
- Pathway lighting [100](#)
- PDC Park Distance Control [86](#)
- "PDC pic." [87](#)
- Pen tray, refer to Storage compartment in center console [115](#)
- Perimeter lighting, refer to Interior lamps [101](#)
- Permissible axle load, refer to Weights [228](#)
- Permissible gross weight, refer to Weights [228](#)
- "Perspective", navigation [145](#)
- "Phone" [182](#)
- Phone book [185](#)
  - deleting all entries [186](#)
  - deleting entry [186](#)
  - displaying entry [185](#)
  - on the Control Display [185](#)
  - select entry [186](#)
  - via iDrive [185](#)
- Phone book, refer to Voice command phone book [186](#)
  - creating entry [186](#)
  - deleting all entries [187](#)
  - deleting entry [187](#)
  - reading entry aloud [187](#)
  - selecting entry [187](#)
  - updating [186](#)
- Phone number
  - deleting individual entry [187](#)
  - dialing from phone book [185](#)
  - dialing via retracting telephone keypad [179](#)
  - redialing [185](#)
  - Top 8 list [186](#)
- Phone preparation package, refer to Preparation package mobile phone [178](#)
- "Pict.format", DVD changer [173](#)
- "Picture", DVD changer [172](#), [173](#)
- Pinch protection system
  - glass sunroof, electric [41](#)
  - power windows [40](#)
- Plasters, refer to First-aid kit [220](#)
- Plastic, refer to Caring for your vehicle brochure
- Playing music tracks in random sequence
  - CD changer [167](#)
  - CD player [164](#)
- Pollen, refer to Microfilter/activated-charcoal filter [107](#)
- Position, refer to
  - Displaying current position [147](#)
  - Saving current position [139](#)
- Power failure [218](#)
- Power output, refer to Engine specifications [226](#)

- Power rear backrests [45](#)
- Power seat, rear [45](#)
- Power socket [116](#)
- Power windows [39](#)
  - convenience operation [32](#)
  - safety switch [40](#)
- Precious wood, refer to Caring for your vehicle brochure
- Preparedness services, refer to Roadside Assistance [219](#)
- "Presets", radio [156](#), [161](#)
- Pressure, tires [200](#)
- Pressure monitoring, tires
  - refer to Flat Tire Monitor [90](#)
  - refer to Tire Pressure Monitor [91](#)
- "Profile", BMW Assist [194](#)
- Programmable
  - buttons [52](#)
  - cruise control [67](#)
- Protective function
  - glass sunroof, electric [41](#)
  - power windows [40](#)
- "Public places, business and shopping", navigation [136](#)
- Publishers [2](#)
- Puncture, Flat Tire Monitor [90](#)

## R

- Radiator, refer to Coolant [210](#)
- Radiator fluid, refer to Coolant [210](#)
- Radio [156](#)
  - Autostore [158](#)
  - controls [152](#)
  - High Definition Radio [162](#)
  - sampling stations [157](#)
  - satellite radio [160](#)
  - selecting the waveband [156](#)
  - storing stations [158](#)
  - switching on/off [153](#)
  - tone control [153](#)
  - updating selection of stations in receiving range [158](#)
  - volume [153](#)
  - weather reports [159](#)
- Radio Data System RDS [159](#)

- Radio key, refer to Remote control/key [30](#)
- Radio ready state [57](#)
  - with Comfort Access [39](#)
- Rain sensor [65](#)
- "RDS", radio [159](#)
- RDS Radio Data System [159](#)
- Reading lamps [102](#)
- "Rear", rear screen [22](#)
- Rear air conditioner
  - cooling adjustment [108](#)
  - switching off [108](#)
  - switching on/off via iDrive [108](#)
- Rear armrest, refer to Center armrest [114](#)
- Rear climate control [108](#)
  - rear refrigerator [117](#)
- "Rear climate control", rear climate control [108](#)
- Rear lamps
  - refer to Tail lamps [214](#)
  - replacing bulbs [214](#)
- Rear lock, rear seat screen [22](#)
- "Rear refrigerator" [117](#)
- Rear refrigerator [117](#)
- Rear-seat area ventilation [107](#)
- Rear seat backrests, electric, refer to Rear comfort seat adjustment [45](#)
- Rear seats
  - adjusting [45](#)
  - adjusting passenger seat from rear [45](#)
  - head restraint adjustment [47](#)
  - heating [49](#)
- Rear seat screen [21](#)
- Rearview mirror [50](#)
- Rear window blind, refer to Sun blinds [112](#)
- Rear window defroster [107](#)
- Rear window safety switch [40](#)
- Reception, radio
  - refer to Changing station [156](#)
  - refer to Updating stations in receiving range [158](#)
- Rechargeable flashlight [113](#)
- "Recirc. air", programmable buttons [52](#)
- Recirculated-air mode, automatic climate control [105](#)
- Reclining seat, refer to Seat adjustment [44](#)
- Recording time, refer to Stopwatch [83](#)
- Reflectors, refer to Tail lamps [214](#)
- Refueling [198](#)
- Remaining distance
  - for service required [78](#)
  - refer to Cruising range [77](#)
- Remaining distance to destination [77](#)
- Remote control [30](#)
  - changing battery [39](#)
  - Comfort Access [38](#)
  - garage door opener [111](#)
  - luggage compartment lid [33](#)
  - malfunction [33](#)
- Removing fog on the windows [106](#)
- Removing head restraints, rear seats [47](#)
- Replacement fuses [218](#)
- Replacement key, refer to New remote controls [30](#)
- Replacement of tires [205](#)
  - changing wheels [215](#)
  - tire replacement [205](#)
- Replacing bulbs, refer to Lamps and bulbs [213](#)
- Reporting an accident, refer to Initiating an emergency call [219](#)
- Reserve, fuel, refer to Fuel gauge [76](#)
- "RESET"
  - Tire Pressure Monitor [92](#)
  - tone control [155](#)
- Resetting tone settings [155](#)
- "Reset tire pressure", Flat Tire Monitor [90](#)
- Residual heat [106](#)
- Restraint systems
  - for children [54](#)
  - refer to Safety belts [48](#)
- Retaining straps, refer to Securing cargo [125](#)
- Retracting telephone keypad [179](#)
- Reverse
  - CD changer [167](#)
  - CD player [164](#)
  - DVD changer [172](#)
- Reverse gear, automatic transmission with Steptronic [63](#)
- "Right", seat heating [49](#)
- "RND"
  - CD changer [167](#)
  - CD player [164](#)
- Road map [135](#)
- Roadside Assistance [219](#)
- Roadside parking lamps [101](#)
- Roadside service, refer to Roadside Assistance [190](#)
- Roaming display, refer to Status lines [20](#)
- Roller sun blind, refer to Sun blinds [112](#)
- Roof load capacity [228](#)
- Roof-mounted luggage rack [125](#)
- Rope, refer to Towing methods [221](#)
- Rotary pushbutton, refer to iDrive [16](#)
- Route
  - bypassing sections [147](#)
  - changing criteria [142](#)
  - changing route [146](#)
  - displaying [145](#)
  - displaying streets or towns/cities [146](#)
  - selecting [141](#)
  - selecting arrow display [145](#)
  - selecting map view [145](#)
- "Route guid.", navigation [144](#)

- Route guidance [144](#)
  - by voice instructions [146](#)
  - changing route specifications [141](#)
  - continuing [144](#)
  - displaying driving route [130](#)
  - distance and arrival [77](#)
  - selecting new route [146](#)
  - starting [144](#)
  - terminating [144](#)
  - volume of voice instructions [146](#)
- "ROUTE GUIDE", navigation [134](#), [140](#)
- Route instructions, refer to Route guidance by voice instructions [146](#)
- "Route preference", navigation [142](#)
- RSC Run-flat System
  - Component, refer to Run-flat tires [205](#)
- Run-flat tires [205](#)
  - flat tire [91](#), [93](#)
  - tire inflation pressure [200](#)
  - tire replacement [205](#), [206](#)
  - winter tires [206](#)

## S

- Sack for skis, refer to Ski bag [117](#)
- Safe braking [123](#)
- Safety [5](#)
- Safety belts [48](#)
  - care, refer to Caring for your vehicle brochure
  - sitting safely [43](#)
  - warning lamp [48](#)
- Safety belt tensioners
  - refer to Airbags [95](#)
  - refer to Safety belts [48](#)
- Safety systems, refer to
  - Airbags [95](#)
  - Driving stability control systems [87](#)
  - Safety belts [48](#)
- Safety tires, refer to Run-flat tires [205](#)
- Sampling, Scan
  - CD changer [167](#)
  - CD player [163](#)
  - radio [157](#)
- Sampling a music track, Scan
  - CD changer [167](#)
  - CD player [163](#)
- "SAT", radio [160](#)
- SAT, waveband [160](#)
- "SCAN"
  - CD changer [167](#)
  - CD player [163](#)
  - radio [157](#)
- Scan, sampling
  - CD changer [167](#)
  - CD player [163](#)
  - radio [157](#)
- "Screen", adjusting brightness [85](#)
- Screw thread for tow fitting [221](#)
- Seats [43](#)
  - adjusting [44](#)
  - automatic backrest width adjustment [44](#)
  - comfort seat [44](#)
  - heating [49](#)
  - in rear [45](#)
  - lumbar support [44](#)
  - memory, refer to Seat, mirror and steering wheel memory [46](#)
  - shoulder support [45](#)
  - storing adjustments [46](#)
  - thigh support [44](#)
  - ventilation, refer to Active seat ventilation [50](#)
- "Seat temp.", seat heating [49](#)
- Seat ventilation, refer to Active seat ventilation [50](#)
- Securing cargo [125](#)
- Selecting
  - menu items with iDrive [19](#)
  - route for navigation [141](#)
- Selecting audio source [152](#)
- Selecting country [132](#)
- Selecting functions, refer to iDrive [16](#)
- Selecting map view [145](#)

- Selecting menu [17](#)
- Selecting transmission range [62](#)
- Selector lever, automatic transmission with Steptronic [62](#)
- Selector lever interlock, refer to Selecting transmission range [62](#)
- Service, refer to Roadside Assistance [190](#), [219](#)
- Service and Warranty Information Booklet for US models [211](#)
- Service car, refer to Roadside Assistance [190](#), [219](#)
- Service required [78](#)
- "Services", BMW Assist [192](#)
- "Service Status", BMW Assist [191](#)
- "SET", setting speed limit [82](#)
- "Set time 1", parked car ventilation [109](#)
- "Set time 2", parked car ventilation [109](#)
- Setting button, refer to iDrive [16](#)
- Setting language on Control Display [84](#)
- "Settings"
  - activating/deactivating Bluetooth link [183](#)
  - pairing mobile phone with vehicle [182](#)
- Settings
  - assistance window [20](#)
  - BMW Night Vision [98](#)
  - data and time [84](#)
  - entertainment [152](#)
  - Key Memory [31](#)
  - language [84](#)
  - units of measure [84](#)
- Setting time, refer to Preselecting activation time [109](#)
- Setting volume, speed-dependent [154](#)

- Shifting, for automatic transmission with Steptronic [62](#)
- Shiftlock, refer to Selecting transmission range [62](#)
- Short commands of the voice command system [230](#)
- "Shortest route", navigation [142](#)
- "Short info", programmable buttons [52](#)
- Shoulder support adjustment [45](#)
- Side airbags [95](#)
- Side-mounted turn signals, replacing bulbs [214](#)
- Side window blind, refer to Sun blinds [112](#)
- Signal horn, refer to Horn [11](#)
- Sitting safely [43](#)
  - with airbags [43](#)
  - with head restraint [43](#)
  - with safety belts [43](#)
- Ski bag [117](#)
- Sliding/tilt sunroof, refer to Glass sunroof, electric [41](#)
- Smokers' package, refer to Ashtray [115](#)
- Snap-in adapter [181](#)
- Snow chains [206](#)
- Socket
  - for Onboard Diagnostics [212](#)
  - for remote control, refer to Ignition lock [57](#)
- Soft closure aid
  - doors, refer to Automatic soft closing [35](#)
  - luggage compartment lid, refer to Automatic soft closing [36](#)
- SOS, refer to Initiating an emergency call [219](#)
- Spare fuses [218](#)
- Spare key [30](#)
  - adapter [30](#)
- Spare tire [216](#)
- Spare wheel, refer to Spare tire [216](#)
- Special oils, refer to Approved engine oils [209](#)
- Speed
  - average [77](#)
  - limit [82](#)
- Speed-dependent volume [154](#)
- Speed limit [82](#)
- Speedometer [12](#)
- "Speed Vol.", speed-dependent volume control [154](#)
- "Split"
  - assistance window for onboard data [83](#)
  - navigation, refer to Display in assistance window [130](#)
- Split screen view, refer to Assistance window [20](#)
- "Sport", EDC Electronic Damper Control [90](#)
- Sport program
  - automatic transmission with Steptronic [63](#)
  - EDC Electronic Damper Control [90](#)
- Stability control, refer to Driving stability control systems [87](#)
- Star button, refer to Programming button function [52](#)
- "START", BMW Assist [190](#)
- "START / RESET", trip computer [78](#)
- Start/Stop button [57](#)
- Starting, refer to Starting engine [57](#)
- Starting difficulties, jump starting [220](#)
- Starting engine [57](#)
- "State / Province", navigation [132](#)
- "State inspection" [79](#)
- Stations
  - refer to Radio [156](#)
  - storing for radio [158](#)
- "Status", BMW Assist [191](#), [193](#)
- "Status: Resetting TPM...", Tire Pressure Monitor [92](#)
- "Status: Tire low!", Tire Pressure Monitor [93](#)
- "Status: TPM active", Tire Pressure Monitor [92](#)
- Status lines [20](#)
  - in the assistance window [21](#)
- Steering wheel
  - adjustment [51](#)
  - assistance getting in and out [52](#)
  - buttons on steering wheel [11](#)
  - heating [52](#)
  - memory [46](#)
  - programmable button [52](#)
  - with multi-function buttons [11](#)
- Steptronic, refer to Automatic transmission with Steptronic [63](#)
- "STOP", trip computer [78](#)
- Stopwatch
  - starting and stopping [83](#)
  - taking an intermediate time reading [83](#)
- Storage, tires [206](#)
- Storage compartments [114](#), [115](#)
  - refer to Center armrest, front [113](#)
  - refer to Center armrest, rear [114](#)
- "STORE", radio [158](#)
- "STORE DATE", deadlines for state vehicle inspections [80](#)
- Storing current position [147](#)
- Storing desired speeds, refer to Programmable cruise control [68](#)
- Storing destination by voice [141](#)
- Storing numbers, refer to Phone book [186](#)
- Storing sitting position, refer to Seat, mirror and steering wheel memory [46](#)



Storing vehicle, refer to Caring for your vehicle brochure  
Straps, refer to Loading [124](#)  
"Street", navigation [133](#)  
"SUBTITLE", DVD changer [173](#)  
Summer tires, refer to Wheels and tires [200](#)  
Sun blinds [112](#)  
Sunglasses compartment [115](#)  
"SVS active", voice command system [23](#)  
Switches  
– all around the steering wheel [10](#)  
– in the comfort area [14](#)  
Switch for battery [218](#)  
Switching cooling function on and off manually [107](#)  
Switching ignition on and off [57](#)  
Switching off engine [58](#)  
Switching off tilt alarm sensor [38](#)  
Switching on  
– audio [153](#)  
– CD changer [165](#)  
– CD player [163](#)  
– DVD changer [171](#)  
– radio [156](#)  
Symbols [4](#)  
– indicator and warning lamps [13](#)

## T

Tachometer [75](#)  
Tail lamps [214](#)  
– replacing bulbs [215](#)  
Tank capacity [198](#)  
– also refer to Capacities [229](#)  
Technical changes, refer to For your own safety [5](#)  
Technical data [226](#)  
Telematics, refer to BMW Assist [189](#)

Telephone  
– accepting calls [184](#)  
– refer to Telephone overview [178](#)  
Telephoning, requirements [184](#)  
Temperature  
– adjusting with automatic climate control [105](#)  
– changing units of measure [84](#)  
– outside temperature warning [75](#)  
– refer to Hot exhaust system [122](#)  
Temperature display  
– interior temperature [105](#)  
– outside temperature [75](#)  
– setting units [84](#)  
Temperature distribution, seat heating [49](#)  
Temperature of coolant, refer to Coolant temperature [76](#)  
Thawing windows, refer to Defrosting windows and removing condensation [106](#)  
The right tires [205](#)  
Thigh support adjustment, refer to Seat adjustment [44](#)  
Third brake lamp, refer to Tail and brake lamps [214](#)  
Three-point belt [48](#)  
Through loading system [117](#)  
Tightening torque for lug bolts, refer to After mounting [217](#)  
Tilting down passenger-side exterior mirror [51](#)  
"Time", setting [84](#)  
Time of arrival [77](#)  
Timer, refer to Preselecting switch-on times [109](#)  
Tire inflation pressure [200](#)  
– loss, refer to Indication of a flat tire [91](#)  
– loss, refer to Low tire pressure message [93](#)

Tire Pressure Monitor [91](#)  
– resetting system [92](#)  
– system limits [92](#)  
– warning light [93](#)  
Tire Quality Grading [203](#)  
Tires  
– age [203](#)  
– breaking-in [122](#)  
– changing [215](#)  
– condition [204](#)  
– damage [204](#)  
– flat tire [215](#)  
– inflation pressure [200](#)  
– pressure monitoring, refer to Flat Tire Monitor [90](#)  
– pressure monitoring, refer to TPM Tire Pressure Monitor [91](#)  
– replacing [205](#)  
– run-flat tires [205](#)  
– size [203](#)  
– size, refer to New wheels and tires [205](#)  
– storage [206](#)  
– tread [204](#)  
– winter tires [206](#)  
"Tires: FTM", Flat Tire Monitor [90](#)  
"Tires: TPM", Tire Pressure Monitor [92](#)  
"TITLE", DVD changer [173](#)  
Tone [153](#)  
– adjusting [153](#)  
– resetting settings [155](#)  
"Tone", tone control [153](#)  
Tools, refer to Onboard tool kit [213](#)  
"TOP", DVD changer [174](#)  
"TOP 8", telephone [186](#)  
Top 8 on phone [186](#)  
– deleting entire list [186](#)  
– dialing phone number [186](#)  
Torque  
– engine [226](#)  
– lug bolts, refer to After mounting [217](#)  
Touch tone dialing [180](#)  
Tow fitting [221](#)

Towing [221](#)  
 – tow fitting [221](#)  
 "Town/City", navigation [132](#)  
 Town/city of destination, entering [132](#)  
 Tow starting [222](#)  
 Track, refer to  
   Dimensions [227](#)  
 Traction aid, refer to DSC [87](#)  
 Traction control, refer to DSC  
   Dynamic Stability Control [87](#)  
 Traffic congestion, bypassing route sections [147](#)  
 Transmission, refer to  
   Automatic transmission with Steptronic [62](#)  
 Transporting children safely [54](#)  
 "Travel information", navigation [136](#)  
 Tray for pens [115](#)  
 Tread depth, refer to Minimum tread depth [204](#)  
 "Treble", treble and bass [154](#)  
 Treble and bass [154](#)  
 Trip computer [78](#)  
 Triple turn signal activation [65](#)  
 Trip odometer [75](#)  
 Trunk, refer to Luggage compartment [119](#)  
 Trunk lid, refer to Luggage compartment lid [35](#)  
 Turning circle, refer to  
   Dimensions [227](#)  
 Turn signals [65](#)  
 – indicator lamp [13](#)  
 – replacing bulbs [214](#)  
 TV  
 – controls [152](#)  
 – switching on [153](#)  
 – volume [153](#)  
 Twist-and-press button, refer to iDrive [16](#)

## U

Undercoating, refer to Caring for your vehicle brochure  
 Uniform Tire Quality Grading [203](#)  
 "Units", changing settings [84](#)  
 Units of measure  
 – average fuel consumption [84](#)  
 – average speed [84](#)  
 – consumption [84](#)  
 – distance [84](#)  
 – temperature [84](#)  
 Universal remote control, refer to Integrated universal remote control [111](#)  
 "Unlock", rear screen [22](#)  
 Unlocking  
 – from inside [34](#)  
 – from outside [32](#)  
 – hood [207](#)  
 – luggage compartment lid [33](#), [39](#)  
 Unlocking without key, refer to Comfort Access [38](#)  
 "UPDATE", BMW Assist [193](#)  
 "Update of engine oil level in process" [209](#)  
 Used batteries, refer to Disposal [218](#)  
 Using the phone [184](#)

## V

Valve screw caps, refer to After mounting [217](#)  
 Vanity mirror, illuminated [51](#)  
 Vehicle  
 – battery [217](#)  
 – breaking-in [122](#)  
 – care, refer to Caring for your vehicle brochure  
 – dimensions [227](#)  
 – loading [124](#)  
 – locking from inside [34](#)  
 – locking from outside [32](#)  
 – parking [58](#)  
 – position, refer to Current position [147](#)  
 – storage, refer to Caring for your vehicle brochure  
 – washing, refer to Caring for your vehicle brochure  
 – weight [228](#)  
 "Vehicle", menus on Control Display [17](#)  
 Vehicle jack, refer to What you will need [216](#)  
 Vehicle jack mountings, refer to Lifting vehicle [216](#)  
 Ventilation [107](#)  
 – draft-free [107](#)  
 – refer to Parked car ventilation [109](#)  
 – refer to Rear ventilation [109](#)  
 Video, refer to DVD changer [170](#)  
 "View", navigation [145](#)  
 Viscosity [209](#)  
 Voice-command phone book [186](#)  
 Voice command system [23](#)  
 – short commands [230](#)  
 Voice instructions for navigation system  
 – muting [146](#)  
 – repeating [146](#)  
 – switching on/off [146](#)  
 – volume [146](#)  
 Volume distribution, refer to Balance and fader [154](#)

## W

Warning and indicator lamps [13](#)  
Warnings, refer to Check Control [80](#)  
Warning triangle [220](#)  
Warranty and Service Guide Booklet for Canadian models [211](#)  
Washer fluid [66](#)  
Washer jets, refer to Windshield washer nozzles [66](#)  
Washing systems, refer to Wiper fluid filler neck [66](#)  
Washing the vehicle, refer to Caring for your vehicle brochure  
Waste receptacle, refer to  
– Ashtray, front [115](#)  
– Center armrest, front [114](#)  
Water on roads, refer to Driving through water [123](#)  
Waveband [156](#)  
– High Definition Radio [162](#)  
"WB", radio [160](#)  
WB, weather reports [159](#)  
Wear indicators in tires, refer to Minimum tread depth [204](#)  
Weather reports [159](#)  
Weights [228](#)  
Wheel/tire combination, refer to New wheels and tires [205](#)  
Wheelbase, refer to Dimensions [227](#)  
Wheel change, spare wheel [216](#)  
Wheel changing between axles [206](#)  
Wheel chock, refer to What you will need [216](#)  
Wheel replacement [205](#)  
Wheels and tires [200](#)  
Width, refer to Dimensions [227](#)

Windshield  
– cleaning, refer to Windshield cleaning [66](#)  
– defrosting, refer to Defrosting windows and removing condensation [106](#)  
Windshield washer system  
– refer to Wiper system [65](#)  
– washer fluid [66](#)  
– windshield washer nozzles [66](#)  
Windshield wipers, refer to Wiper system [65](#)  
– care, refer to Caring for your vehicle brochure  
– changing wiper blades [213](#)  
Winter tires [206](#)  
– changing [215](#)  
– condition [204](#)  
– run-flat tires [206](#)  
– speed limit selection [82](#)  
– storage [206](#)  
Wiper blade replacement [213](#)  
Wiper fluid, filler neck [66](#)  
Wiper system [65](#)  
"With highway", navigation [142](#)  
"With map", navigation [135](#)  
Without freeway, refer to Changing route criteria [142](#)  
Wood decoration, refer to Caring for your vehicle brochure  
Wordmatch principle for navigation [142](#)  
Wrenches/screwdrivers, refer to Onboard toolkit [213](#)

## X

Xenon lamp, replacing bulbs [213](#)

## Y

"YES", navigation  
– deleting address book [140](#)  
– deleting destination list [138](#)  
– deleting individual destinations from address book [140](#)  
"YES", Tire Pressure Monitor [92](#)  
Your individual vehicle [5](#)

## Z

"Zoom", BMW Night Vision [98](#)





More about BMW

[bmwusa.com](http://bmwusa.com)



The Ultimate  
Driving Machine

01 41 0 013 316 ue

